

# Gasification of waste for energy carriers

A review



IEA Bioenergy

## Gasification of waste for energy carriers

### A review

Lars Waldheim, Waldheim Consulting

Acknowledgement: the author expresses his gratitude to Aranda Guadelope Almansa of ECN, part of TNO, the Netherlands, for her comments and suggestions in preparing this report

IEA Bioenergy, also known as the Technology Collaboration Programme (TCP) for a Programme of Research, Development and Demonstration on Bioenergy, functions within a Framework created by the International Energy Agency (IEA). Views, findings and publications of IEA Bioenergy do not necessarily represent the views or policies of the IEA Secretariat or of its individual Member countries.

Copyright © 2018 IEA Bioenergy. All rights Reserved

ISBN 978-1-910154-56-4.

**Published by IEA Bioenergy**

**Cover photo: Courtesy of Enerkem Inc.**

## Content

<b>Abbreviations .....</b>	<b>5</b>
<b>Executive Summary.....</b>	<b>8</b>
<b>1. The scope and objective of this work .....</b>	<b>15</b>
<b>1.1. BACKGROUND.....</b>	<b>15</b>
<b>1.2. MOTIVATION .....</b>	<b>15</b>
<b>1.3. THE SCOPE OF THE STUDY .....</b>	<b>18</b>
<b>1.4. METHODOLOGY .....</b>	<b>18</b>
<b>2. Wastes as a gasifier fuel .....</b>	<b>19</b>
<b>2.1. WASTE FUEL CHARACTERISTICS.....</b>	<b>19</b>
<b>2.2. WASTE FUEL STANDARDS .....</b>	<b>23</b>
2.2.1. CEN/TC292 -Waste characterization .....	23
2.2.2. RDF standards .....	23
2.2.3. CEN/TC 343 - SRF standards .....	24
2.2.4. ISO/TC 300 .....	28
<b>3. Waste quantities and disposal costs.....</b>	<b>28</b>
<b>3.1. WASTE SITUATION IN THE EU .....</b>	<b>28</b>
<b>3.2. WASTE AND WASTE TREATMENT IN JAPAN.....</b>	<b>33</b>
<b>3.3. WASTE SITUATION IN THE USA .....</b>	<b>37</b>
<b>3.4. OTHER ASIAN STATES .....</b>	<b>40</b>
<b>4. Waste policies and regulatory considerations.....</b>	<b>41</b>
<b>4.1.1. OVERVIEW OF WASTE POLICIES (FROM DISPOSAL TO CIRCULAR ECONOMY) .....</b>	<b>41</b>
<b>4.2. INTERNATIONAL POLICIES.....</b>	<b>43</b>
4.2.1. Policies.....	43

4.2.2.	Conventions .....	44
<b>4.3.</b>	<b>EU POLICY AND REGULATIONS .....</b>	<b>46</b>
4.3.1.	Directives .....	48
<b>4.4.</b>	<b>POLICIES IN JAPAN .....</b>	<b>59</b>
4.4.1.	Regulations .....	64
<b>4.5.</b>	<b>POLICY IN THE USA .....</b>	<b>67</b>
4.5.1.	US Regulations .....	72
<b>5.</b>	<b>Gasification technologies applied to waste .....</b>	<b>75</b>
<b>5.1.</b>	<b>PRINCIPLES OF GASIFICATION PROCESSES .....</b>	<b>76</b>
5.1.1.	Autothermal and allothermal gasifiers .....	78
5.1.2.	Operating conditions for waste gasifiers and other gasifiers.....	80
5.1.3.	Typical bulk gas compositions .....	81
<b>5.2.</b>	<b>GASIFICATION REACTORS .....</b>	<b>81</b>
5.2.1.	Co-current (downdraft) moving bed gasifiers .....	85
5.2.2.	Co-current (updraft) moving bed gasifiers .....	85
5.2.3.	Other forms of moving bed gasifier .....	87
5.2.4.	Fluidized bed gasifiers.....	87
5.2.5.	Entrained flow gasifiers.....	92
5.2.6.	Other types of gasifiers .....	93
<b>6.</b>	<b>Gas cleaning and the use of the product gas.....</b>	<b>93</b>
<b>6.1.</b>	<b>CONTAMINANTS AND EMISSION PRECURSORS .....</b>	<b>93</b>
<b>6.2.</b>	<b>GAS CLEANING TECHNOLOGIES .....</b>	<b>95</b>
6.2.1.	Particulate removal .....	100
6.2.2.	Tar removal .....	104
6.2.2.1.	Catalytic tar conversion .....	106
6.2.2.2.	Thermal cracking of tars / plasma tar removal .....	107
6.2.2.3.	Physical tar removal .....	109
6.2.2.4.	Temperature control .....	111
6.2.3.	Halides (chloride, fluoride and bromine) .....	111
6.2.4.	NO <sub>x</sub> precursors .....	113
6.2.5.	Sulphur species .....	114
6.2.6.	Heavy metals, mercury .....	120

6.2.7.	TOC, dioxins and furans, CO .....	120
6.2.8.	Conclusions on gas cleaning processes .....	122
6.3.	<b>GAS CLEANING AND POWER/CHP PERFORMANCE .....</b>	<b>124</b>
7.	<b>Gasifier technologies.....</b>	<b>127</b>
7.1.	<b>INDUSTRIAL GASIFIERS.....</b>	<b>127</b>
7.1.1.	CEMEX Rüdersdorf, Germany .....	127
7.1.2.	Anhui Conch Kawasaki Engineering Co., Ltd., China .....	130
7.1.3.	Vicat, Crechy, France .....	131
7.1.4.	ESKA, the Netherlands.....	132
7.1.5.	Innovative Environmental Solutions, UK .....	135
7.1.6.	Stora Enso ( <i>fka</i> Corenso United), Finland .....	137
7.2.	<b>CO-FIRING FOR POWER AND HEAT .....</b>	<b>138</b>
7.2.1.	Essent/RWE AMERGAS, The Netherlands .....	138
7.2.2.	Lahti I (Kymijärvi I), Finland.....	143
7.3.	<b>COMBINED POWER AND HEAT .....</b>	<b>148</b>
7.3.1.	Two-stage incinerators.....	149
7.3.1.1.	An example of a grate gasification process; Energos .....	151
7.3.1.2.	An example of a fixed bed; Nippon Steel Direct Melting Process.....	153
7.3.1.4.	An example of a fluidized bed gasification process, Outotec .....	155
7.3.2.	Waste gasification with gas cleaning, “true gasification” .....	158
7.3.2.1.	Air Products, Teesside, UK .....	159
7.3.2.2.	CHO Power, Morcenx, France .....	164
7.3.2.3.	Concord Blue ( <i>fka</i> Blauer Turm <i>aka</i> Blue Tower) .....	171
7.3.2.4.	Lahti II (Kymijärvi II) .....	174
7.3.2.5.	Plasco, Ottawa, Canada .....	183
7.3.2.6.	Schwarze Pumpe, Germany .....	188
7.3.2.7.	Syngas Products ( <i>fka</i> NEAT) .....	190
7.3.2.8.	Synnov Déchets, Villers-sous-Montrond.....	193
7.3.2.9.	SynTech Bioenergy/KEW Technology, UK .....	194
7.3.2.10.	Taylor Biomass Energy, LLC, Montgomery, NY, USA .....	196
7.3.2.11.	Thermoselect and licensee JFE <sup>294, 295</sup> .....	198
7.3.2.12.	Other processes.....	202
7.4.	<b>CHEMICALS AND FUELS .....</b>	<b>203</b>
7.4.1.	<b>CHEMICALS.....</b>	<b>203</b>
7.4.1.1.	EBARA UBE Process EUP .....	203

<b>7.4.2. FUELS .....</b>	<b>206</b>
7.4.2.1. APP (Advanced Plasma Power Ltd.) .....	206
7.4.2.2. Enerkem .....	210
7.4.2.3. Ineos Bio .....	216
7.4.2.4. Fulcrum Bioenergy and Thermochemical Recovery Inc. (TRI) .....	222
7.4.2.5. Synova, ECN, Dahlman and Ambigo .....	228
7.4.2.6. Other processes .....	235
<b>8. Discussion .....</b>	<b>235</b>
<b>8.1. R&amp;D NEEDS .....</b>	<b>236</b>
<b>8.2. WASTE GASIFICATION PERFORMANCE .....</b>	<b>239</b>
<b>8.3. BARRIERS AND OPPORTUNITIES FOR GASIFICATION.....</b>	<b>241</b>
<b>8.4. ECONOMICS OF WASTE INCINERATION AND GASIFICATION</b>	<b>243</b>
<b>8.4.1. POWER AND CHP BACK-OF-AN-ENVELOPE ECONOMICS .....</b>	<b>245</b>
<b>8.4.2. FUEL PRODUCTION BACK-OF-AN-ENVELOPE ECONOMICS...</b>	<b>251</b>
<b>9. Conclusions .....</b>	<b>252</b>
<b>Appendix 1 – Waste and SRF standards .....</b>	<b>i</b>
<b>Appendix 2 – Limiting Emission Values 2016 .....</b>	<b>iv</b>
<b>EU EMISSION LIMITS (EID, MCP DIRECTIVES).....</b>	<b>IV</b>
<b>JAPANESE EMISSION LIMITS .....</b>	<b>V</b>
<b>US EPA EMISSION LIMITS.....</b>	<b>VI</b>
<b>COMPARISON OF EU, JAPANESE AND US LEV’S.....</b>	<b>VII</b>
<b>Appendix 3 Waste Gasification developers.....</b>	<b>viii</b>
<b>Appendix 4 Waste Gasification Plants and Projects .....</b>	<b>xix</b>

## Abbreviations

<i>aka</i>	also known as
ar	as received
BAT	Best available technology
B.C.	Before Christ
BREF	Best available technology (BAT) reference document (EU)
BACT	Best available control technology (USA)
BATC	Best available technology (BAT) conclusions (EU)
BOCM	Bilateral Offset Crediting Mechanism (Japan)
CO <sub>2e</sub>	CO <sub>2</sub> -equivalents
CAA	Clean Air Act (USA)
CAA	Clean Air Act Amended (USA)
CADDET	Centre for the Analysis and Dissemination of Demonstrated Energy Technologies
CCS	Carbon Sequestration and Storage
CCU	Carbon Sequestration and Utilisation
CDW	Construction and demolition wastes
CEN	European committee for standardisation
CFB	Circulating fluidized bed
CFC	Chlorofluorocarbon
CFD	Computational fluid dynamics
CFR	Code of Federal Regulations (USA)
CHP	Combined heat and power (co-generation)
CLRTAP	Convention on long-range transboundary air pollution
CNG	Compressed natural gas
CW	Commercial wastes
Daf	Dry and ash-free
d.s.	Dry substance
DEFRA	Department for Environment, Food & Rural Affairs (UK)
DOE	Department of Energy (USA)
EA	Environmental Agency (EU)
DG	Directorate general (EU)
EAP	Environmental Action Plans (EU)
ECJ	European Court of Justice
ECN	Energy Research Center Netherlands
ECCP	European Climate Change Programme
EDP	Energy Demonstration Program, see EIB
EEA	European Economic Area agreement
EIB	European Investment bank
EIPPCB	European Integrated Pollution Prevention and Control Bureau
EFTA	European free trade association
EIA	Environmental Impact Assessment
ELV	End-life of Vehicles Directive
EMEP	European Monitoring and Evaluation Programme
EPA	Environmental Protection Agency (USA)
EPR	Extended Product Responsibility
ESP	Electrostatic precipitator
ETS	Emission Trading System (EU)
EU	European Union
EWC	European Waste Catalogue (EU WFD)
FB	Fluidized bed
FIT, FiT	Feed-in tariff
<i>Fka</i>	Formerly known as
FSU	Former Soviet Union
GACT	Generally Available Control Technologies or Management Practices (CAAA USA)
GDP	Gross Domestic Product

GHG	Greenhouse gases
HFC	Hydrofluorocarbons
HCFC	Hydrochlorofluorocarbons
HSWA	Hazardous and Solid Waste Amendments (RCRA USA))
HTW	High-temperature Winkler (gasification process)
HW	Hazardous wastes
IEA	International Energy Agency
IW	Industrial wastes
IED	Industrial Emissions Directive (EU)
IGCC	Integrated Gasification Combined Cycle
IPCC	Intergovernmental Panel on Climate Change
IPPC	Integrated Pollution Prevention and Control, (EU)
ISO	International standardisation organisation
IW	Industrial wastes
JCM	Joint Crediting Mechanism (Japan)
JPY	Japanese Yen
JVETS	Japanese Voluntary Emission Trading Systems
J-VER	Japanese Verified Emissions Certificate system
LAER	Lowest Achievable Emission Rate (CAAA USA).
LCP	Large combustion plant (EU)
LCV	Lower calorific value
LEV	Limiting emission values
LFD	Landfill directive (EU)
LOI	Loss of ignition
LOX	Liquid oxidation scrubbing process (for sulphur removal)
MACT	Maximum available control technology (USA)
MBM	Meat and bone meal
MBT	Mechanical and biological treatment
MCP	Medium combustion plant (EU)
MDG	Millennium development goals (UN)
METI	Ministry of Economy Trade and Industry (Japan)
MoE	Ministry of Environment (Japan)
MRF	Material recovery facility
MSR	Market stability reserve (EU ETS)
MSW	Municipal solid wastes
n.a.	not applicable
NAAQS	National Ambient Air Quality Standards (USA)
NDC	Nationally Determined Contributions (UNFCCC Paris agreement)
NER	New Entrant Registry (EU ETS)
NESHAP	New Emission Source Standard for Hazardous Air Pollutant (CAAA USA)
NIB	Nordic Investment Bank
n.l.	not limited
NSPS	New Source Performance Standards (CAA USA)
OFGEM	Office of Gas and Electricity Markets (UK regulator)
O&M	Operations and maintenance
PAC	Pulverized activated carbon
PAH	Polyaromatic hydrocarbons
PCB	Polychlorinated biphenyls
PFC	Perfluoro hydrocarbons
PFOS	Perfluorooctane sulfonic acid
PM	Particulate matter, number indicates cut-off size in microns
POP	Persistent organic pollutants
PPA	Power purchase agreement
PPP	Polluter Pays Principle
PPW	Paper and Packaging Waste Directive (EU)
PSD	Prevention of Significant Deterioration (CAA USA)



PV	Photovoltaic
RACM	Reasonably Available Control Measures (CAA USA)
RACT	Reasonably Available Control Technology (CAA USA)
RCRA	The Resource Conservation and Recovery Act (USA)
RDF	Refuse derived fuel
RE	Renewable Energy
RED	Renewable Energy Directive (EU)
RFP	Reasonable Further Progress (CAA USA)
RFS	Renewable fuel standard (USA)
RME	Rape oil methyl ester, bio-diesel
ROC	Renewable order certificate (UK)
RPS	Renewable Portfolio Standard (USA)
RVO	Netherlands Enterprise Agency
SCR	Selective catalytic reduction (of NO <sub>x</sub> )
SDG	Sustainable development goals (UN)
SIP	State Implementation Plans (CAA USA)
SLF	Shredder light fraction
SNCR	Selective non-catalytic reduction (of NO <sub>x</sub> )
SPV	Special purpose vehicle (e.g. project company, at arm's length from mother)
SPK	Synthetic paraffinic kerosene (ASTM D7566)
SRF	Solid recovered fuel
SWIP	Small waste incinerator plant (UK)
t, tonnes	metric tons (1 000 kg)
TC	Technical committee
TNAC	Total number of allowances in circulation (EU ETS)
tpd	tonnes per day
tpa	tonnes per year (annum)
UNCED	1992 United Nations Conference on Environment and Development
UNECE	United Nations Economic Commission for Europe
UNFCCC	The UN Framework Convention on Climate Change 1992
UNEP	United Nations Environmental program
VOC	Volatile organic compounds
WESP	Wet electrostatic precipitator
WFD	Waste Framework Directive (EU)
WID	Waste Incinerator Directive (EU)
WHO	World Health Organisation
WMO	World Meteorological Organisation
WtE	Waste to energy (installation)
WtF	Waste to fuel (installation)
WtL	Waste to liquids
WW I	World War I (1914-18)
WW II	World War II (1939-45)

## Executive Summary

The primary scope and focus of IEA Bioenergy Task 33, "Thermal Gasification of Biomass", is to follow the developments in the area of biomass gasification with the purpose of providing a comprehensive source of information on activities in this field in the participating countries. A dedicated web site is publicly available (<http://task33.ieabioenergy.com>).

Although the main focus of the task is material of biomass origin, also waste feedstocks are of interest as materials normally considered as "wastes" are to a large extent composed of biomass materials and the fuel characteristics (high volatile matter content, low fixed carbon content etc.) and product gas characteristics (e.g. tar contamination) are similar, and therefore similar gas cleaning techniques is used. For this reason, waste gasification is always to some extent included in the Task activities and from time to time, have been more in focus, e.g. as topic for a special project in the period 2016-2018, which this report represents. The methodology used in this study has mainly been to collect information from public sources. In addition, in some cases direct contacts were also taken to obtain more information. The work has also involved some contacts with mainly IEA Bioenergy Task 36, "Integrating Energy Recovery into Solid Waste Management".

The report initially describes wastes in a broad sense, but excluding hazardous wastes, as a fuel for thermal treatment process. The report continues by giving a brief overview of the waste and waste treatment situation in the EU, Japan and the USA and also summarises the policy and regulatory framework for waste treatment in the above jurisdictions. This is done from a perspective of the impact of the policies and regulations on the thermal treatment of waste in general, and in particular on the impact on waste gasification technologies.

On the technical side, the report describes the gasification and gas cleaning technologies used for waste. The focus of the report is on waste gasification in combination with pre-combustion gas cleaning, i.e. advanced waste gasification technologies, as this combination is key to the main advantage of waste gasification technologies that motivates many of the developments in this field. Furthermore, the state-of-the-art in waste gasification is presented by descriptions of a number of projects for different applications and the associated developers. The technical scope of these applications ranges from direct use of the raw fuel gas in furnaces and boilers to advanced technologies where cleaned gas is used in more efficient steam cycle boilers, engines and gas turbines, as well as for the production of chemicals and liquid energy carriers.

Finally, the competitive position of advanced waste gasification technologies relative to the conventional technology (thermal treatment by one or two-stage incineration with heat recovery), the barriers for introducing the technology on the market, R&D needs and the results of a simplistic economic evaluation are discussed.

The information collected from public sources has also been used to compile a list, included as Appendix 3 and 4 of this report, of technology developers/suppliers and waste gasification projects in various stages ranging from historical projects, operational projects and projects in planning. However, this listing does not pretend to be complete and the data will change over time.

### **Waste as an energy resource**

Waste treatment is of high importance to all societies as it is linked to other issues such as health, pollution of land, air and water as well as climate change and unsustainable resource utilization. Despite policy actions to curb waste generation, the waste quantity generated is still growing due to population increase and life-style changes. The global quantities of wastes that could be treated by thermal methods amounts to the order of 3 billion tonnes annually. Some of this is already processed in incinerators but still a dominant fraction is disposed of in landfills. Even so, in terms of

the energy content and also the GHG emissions, waste overall contributes a small fraction (3-4 %) of the global energy usage and GHG emissions. Nevertheless, it is still a significant energy potential to valorise and the management of this quantity in itself is a challenge.

The disposal methods used of old such as of dumping waste on some marginal land or in rivers or oceans have proven to generate a number of problems (methane emissions, soil and groundwater contamination, plastic soup in the oceans etc.). Even if controlled and engineered landfills are used, both the material disposed of and its energy content are lost. In the waste hierarchy, which is a principle guiding policy in this area, the preferred order of waste management is prevention of waste generation, reuse, recycling and recovery of wastes, while disposal in landfills or by other means is at the bottom. Apart from prevention, reuse and recycling, thermal treatment by incineration with energy recovery is the main alternative to disposal, as in addition to the energy recovery, it sanitizes the waste and reduces its volume. Nevertheless, in the absence of policy interventions to reduce landfilling, improve landfill management procedures or to enforce waste recycling and treatment practices, disposal by landfilling is still a widely used waste management method in many parts of the world as the cost has been, and still is, relatively low. Under such circumstances, thermal treatment has not been feasible, but as landfill space becomes more limited, management within the legal perimeter becomes costlier and societal acceptance decreases, thermal treatment is gradually gaining a stronger position. In many places such as in Japan and Northern Europe thermal treatment is the dominating waste management method and the capacity is also being expanded very rapidly in e.g. China.

The state-of-the-art thermal treatment technology is waste incineration with energy recovery to mainly power, i.e. a thermal power cycle composed of combustion of the waste to generate steam used to drive a steam turbine generator (often denoted waste-to-energy, WtE). There are on the order of some two thousand such installations world-wide of which maybe one hundred are using various gasification technologies. However, to avoid corrosion issues caused by the presence of contaminants in wastes, notably chlorine, the steam superheater temperatures are lower than for conventional thermal power plants, only 400-470 °C compared to from 500 °C up to almost 600 °C. This causes the conversion efficiency of waste incinerators to be significantly lower, only 20-25 %, compared to the efficiency of other thermal power plants using conventional fuels, 35-45 % for solid fuels and up to even 60 % in large gas turbine combined cycles. In the past, operational requirements and emission control of waste incinerators were also less regulated than today. This is still reflected in a low public acceptance of incinerators, despite that stringent regulatory requirements for efficient emission control monitoring have gradually been mandated.

But even if more stringent air pollution control and ash disposal methods have improved the emission footprint and more or less sophisticated energy recovery is used, the products of waste incineration are limited to power, generated at far lower efficiencies than other thermal power plants, and possibly heat. As the economy of an incinerator is based largely on revenue from receiving waste for treatment, the drivers are weak for increasing the efficiency beyond regulatory standards, e.g. to qualify as energy recovery (R1) rather than disposal (D10) in the EU.

In this perspective waste gasification has advantages. However, sometimes the term waste gasification is used for a technology where none or a very limited part of the improvement potential of gasification technologies is realized, i.e. the waste is converted into a combustible gas in a gasifier only to be directly combusted in a close-coupled furnace with heat recovery by steam generation, and the exhaust flue gas is then treated in conventional waste incinerator emission control equipment. Such gasifiers without pre-combustion gas cleaning can be designated as two-stage incinerators, (or sometimes "incinerators in disguise" by anti-incinerator NGOs), as opposed to "true gasification" in which more or less extensive gas cleaning takes place before the product gas is used. The performance of such two-stage gasification incineration technologies can, at best,

be similar to a comparable incinerator as the presence of contaminants in the furnace and heat recovery section limits the steam temperature, and hence the efficiency, in the same way as for conventional incinerators.

### Waste gasification technology

The focus of the report is therefore on the “true gasification” systems, i.e. where the use of gas cleaning is an enabling technology to not only achieving a higher conversion efficiency to power, but also to produce a synthesis gas that can be catalytically converted to chemicals and fuels by well-established commercial processes (waste-to-liquids, WtL). The figure below illustrates the differences between a conventional waste incinerator (left leg), gasifiers being two-stage incinerators (second left leg) and true gasification systems with partial and complete gas cleaning, respectively (the right-most legs).

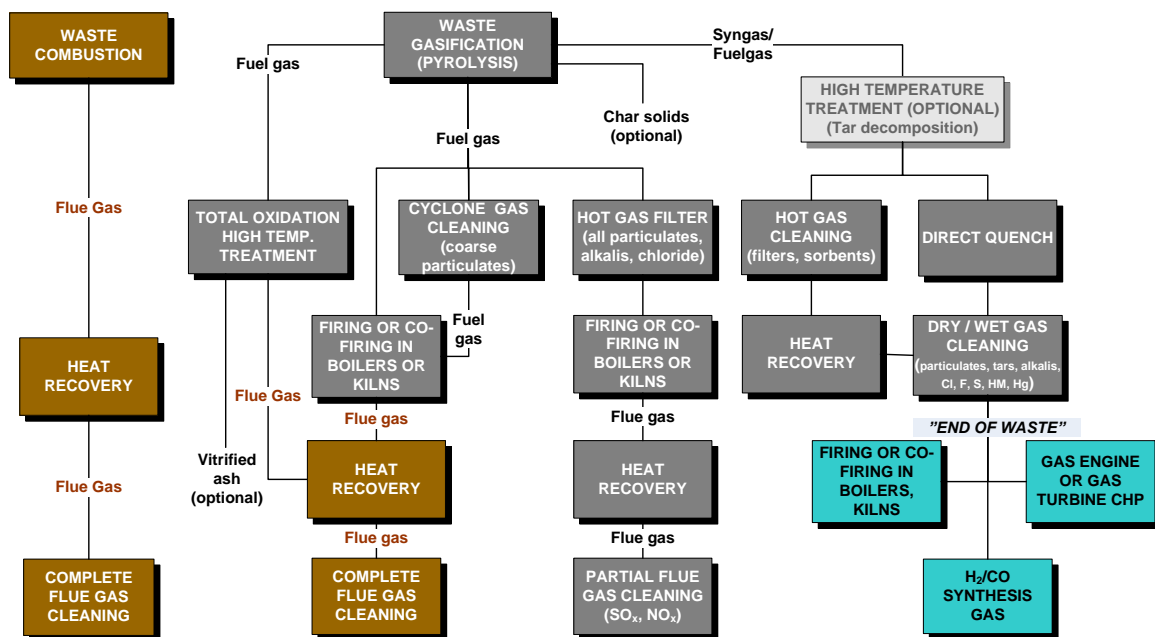

There has been a wide variety of gasification and gas cleaning technologies used. This is in itself a sign that the technology is not mature and that the selection of alternative processing routes has not been narrowed down to a more limited number of varieties that have proven to be more cost-efficient and reliable than other options tried. The gasifiers are typically fixed beds or fluidized beds of similar designs as in incineration (grates, kiln, fluid beds etc.). Due to the fuel characteristics, entrained flow gasifiers are not in use other than for pumpable, liquid wastes (contaminated oils, etc.).

For gasification technologies, the presence of so-called tars (a mixture of heavy hydrocarbons formed during fuel devolatilization) in the concentrations typical of most gasifiers makes tar removal the primary target for gas cleaning, as tars interfere with heat recovery via gas cooling and also additional gas cleaning addressing other contaminants. The primary method for removal of tars in waste gasification systems is by thermal decomposition downstream of the gasifier operating at elevated temperatures relative to the gasifier temperature. Another less common way to remove tars used is by scrubbing with a suitable organic liquid to absorb tar hydrocarbons. Other gasification-specific issues are that sulphur compounds are present in a different chemical form than in an incinerator and the formation of ammonia and predominantly NH<sub>3</sub> from fuel bound nitrogen.

In the case of sulphur present in the waste fuel, it is present predominantly as H<sub>2</sub>S. Pre-combustion gas cleaning technologies therefore rely on the adoption and adaption of technologies used in other

industries e.g. chemical, oil and gas industries. This is an area where in particular research could assist in improving the outlook for waste gasification by providing suitable and cost-efficient cleaning methods suited for the scale of operation of thermal treatment of waste.

Ammonia, which is largely oxidised to NO when the gas is combusted or is undesirable when the gas is used for synthesis of other fuels, can be removed by scrubbing but then affects the water cleaning. Alternatively, if a combustion process is used, there is also the opportunity to use established post-combustion de-NOx technologies.

Other contaminants are removed by cleaning technologies that are similar to what is used in incineration processes and other industries (cyclones and filters for particulate removal, sorbents and scrubbers to remove acid gases and mercury, etc.), and therefore the adaption of these to suit gasification conditions does not constitute a technical barrier as significant as tars and sulphur cleaning.

However, in terms of environmental performance, legislation in the EU and elsewhere for incinerators implies that the regulated contaminants must be removed to an extent of 90-95 %, or even more, relative to their presence in typical waste fuels. For the use of the gas generated from waste for the purpose of chemical synthesis, the gas cleaning requirements are even higher than this. Therefore, gasification systems, where the exhaust gas is subject to the same regulations, cannot be expected to drastically reduce the emissions, compared to conventional incinerators. But as pre-combustion cleaning is performed on a smaller gas volume than post-combustion cleaning, it may result in less secondary wastes than the conventional incinerator system, giving some cost advantages.

In addition to the potentially higher efficiency, also other interactions between policy and technology have promoted waste gasification. In Japan, the lack of space for landfills made waste incineration a preferred technology as early as in the 1970's. In 1998, one decisive policy intervention mandated that new waste incineration plants have ash melting facilities in order to reduce dioxin in fly ash and leaching from landfills. This triggered several developments making Japan the primary market for two-stage waste gasification technologies because such gasification systems could vitrify the ash as an integrated part of the process and without consuming external energy (electricity or fossil fuels), but this required also sacrificing part of the efficiency to energy exported. Although the vitrification was made less of an absolute requirement ten years later, in 2008, there are still some one hundred gasifiers in operation in Japan today. However, the technologies employed in Japan had difficulties to penetrate the market in Europe and USA. Another example is the UK, where the use of "advanced thermal treatment" of waste has been promoted for over a decade and has spurred project developments and some dozen installations using various forms of gasification, mainly in two-stage incineration configurations, but also in a number of cases with extensive gas cleaning.

Already with partial gas cleaning, i.e. removing chlorine using sorbents and the particulates in the gas, such a gas can be used in a downstream boiler at improved steam conditions and energy. Since 2012 a CHP plant at 50 MW<sub>e</sub> output has been in operation in Lahti, Finland on SRF and contaminated wood. This CHP plant has above 30 % conversion efficiency to electricity and if designed as power only, would reach 35 %.

There are also some examples of installations at a scale of 1.5 to 10 MW<sub>e</sub> in France, the UK and elsewhere (e.g. Morcenx, Tyseley, Fort Hunter Liggett, etc.) using cleaned gas in internal combustion engines (sometimes also including a bottoming steam cycle) and reaching efficiencies in the range 25-35 %. Furthermore, there are developers that are targeting the use of the gas in gas turbine combined cycles (e.g. Synova, Taylor Bioenergy, etc.) to reach even higher conversion efficiencies, even if a notable twin-plant project a few years back (Tees Valley 1 and 2) never succeeded to

come into operation.

Using gasification and gas cleaning to generate a synthesis gas has been less in focus until recently, even if the efficiency for producing fuels and chemicals is higher than for production of electrical energy, of the order of 50 % or more. There is one plant using plastic waste to produce ammonia that has been in operation in the Tokyo area in Japan for more than a decade. Another plant is in early operation in Edmonton, Alberta, Canada to produce methanol or ethanol from RDF. Yet another industrial scale plant is in construction in the Tahoe-Reno area of Nevada, USA, where RDF will be converted to FT fuels, and there is also a smaller demonstration installation in construction at Swindon, UK, where RDF will be converted to synthesis gas for further conversion to bio-methane. Fuels from waste has come more in focus in the recent years due to the interest for substituting fossil fuels in the transport sector, and both the US RFS2 system and the EU RED recognises in principle such fuels as biofuels, with some caveats regarding the fossil part of the waste.

The examples of plants highlighted above, and others, are described in more detail in the report.

### **Market penetration**

Despite the efficiency advantages of waste gasification, there have been difficulties in introducing the technology on the market. In many locations, the economic incentives for any form of waste-to-energy (WtE) plant have not been attractive compared to landfilling. Furthermore, conservatism combined with strict emission regulations and market conditions have not favoured the introduction of innovative but less proven technologies. Within the EU, all thermal treatment of wastes, including gasification and any downstream combustion equipment consuming the gas, is defined as incineration and subjected to incinerator legislations. However, if the gas is sufficiently cleaned prior to its combustion (end-of-waste in the figure above), the gas becomes a product in its own right and downstream equipment is not a part of an incinerator. The status of a waste gasifier is less clear in the USA and subject to interpretation of federal legislation at the state level. In Japan, the emissions accepted by the client and local authorities is more determining than the nature of the conversion equipment.

Nevertheless, and as is described in the report, there have not been many plants in which waste gasification in combination with a more extensive gas cleaning have been used, and some of these have been associated with more or less severe teething problems. Problems have been associated with the heterogeneity of the feed wastes, in particular when directly gasifying MSW. There have also been issues caused by the quality of the RDF resulting from pre-treatment of MSW and also with achieving the gas cleaning intended.

This means that the accumulated experience from such installations is not sufficient to validate to what extent, and under which circumstances, the performance and environmental advantages of advanced gasification technologies can be realised. However, at present there are a number of new installations being built or in planning for the production of both power and fuels that are hopefully successful and can contribute to clarifying the position of waste gasification.

### **Economic considerations**

A simplistic economic evaluation, using what are considered average market conditions, gives some indicative results on the feasibility of gasification technologies. When the fuel cost is changed to become a gate fee revenue, the investment-related capital costs becomes the major cost driver.

The data indicates that for both conventional incinerators and gasification plants, the magnitude of the specific investment is around 10 000 €/kW<sub>e</sub>, i.e. significantly higher than for conventional power and CHP plants. For fuel production the specific investment relating to the output energy is lower, 4 000- 6 000 €/kW fuel, as the conversion efficiency is significantly higher than for the production of

electric energy. This may seem surprising, but if the specific investment instead is related to the energy input, both applications are fairly similar in terms of specific investment.

Furthermore, and unlike other energy installations, the drivers to increase the efficiency of waste incineration installations *per se* are less strong. For both conventional and gasification-based systems, the gate-fee is the dominant revenue stream for power-only plants, and together with heat sales a very significant part of the revenues for CHP systems. Based on the numbers of the simplistic economic estimates, even conventional incinerators do not show good economic results if only seen as a mere power plant project that only receives the average market revenues for power and heat and using an opportunity fuel. Break-even is relying on combinations of supports and for monetarization of additional societal services in waste treatment such as e.g. investments subsidies and financing assistance, as in Japan, landfill taxation increasing the gate fees and incentive pricing for the electric power products produced.

So, even if gasification technologies are more efficient, the specific investment must also at least be comparable or lower to conventional incinerators to really be attractive. Investment costs for most installations are at this stage in the development in line with conventional incinerators, with the exception of the CHP plant in Finland referred to above that had a specific investment cost that is closer to a biomass CHP. However, because these gasification plants also represent first-of-a-kind installations, and there is less operating experience, the data is not quite comparable to technically and commercially mature incineration technology.

In contrary to the power and heat generation, the economy of producing renewable fuels looks very interesting, even if it requires the most extensive gas cleaning. The efficiency is high compared to incinerators that produce only power, which reduces the specific investments and generates a high output stream, and the value of this stream is higher than for power or heat on an energy basis. Furthermore, there is no other established waste value chain that competes for this type of product.

### **Policy issues**

There are also some policy issues that can change the outlook for gasification systems. Policy interventions to decrease disposal of waste directly such as landfill bans, restrictions, or taxation promote recycling and treatment of residual wastes by e.g. thermal treatment in general. However, the competitive situation between well-established waste incineration technologies and the emerging gasification technology means that such measures on their own may not be sufficient to make gasification installations feasible.

Another and stronger form of policy driver, and in line with circular economy principles, is by setting ambitious efficiency performance targets for new installations and using these as a driver for technology development. Although this would be technology neutral and stimulate innovations also in the state-of-the-art commercial technologies, this would also require developments and associated costs for these established technologies, thereby reducing the distance to gasification-based technologies where the potential for higher efficiency would then be more appreciated.

Outside the conventional thermal conversion of wastes, the policies for decarbonization of the transport sector have, among other pathways, recognized the potential for utilizing wastes for the production of transport fuels, waste-to-liquids (WtL). Promotional policies and incentives can directly stimulate developments in this field. This area has already attracted some interest recently, as noted above. For this application, gasification is a key technology both for biomass and wastes and there is no other well-established conversion technology to compete with.

### Key messages

- Waste gasification technologies integrated with more or less extensive gas cleaning (“true gasification”) enable a higher conversion efficiency to power than in conventional incinerators at similar capacity, i.e. making better use of the energy potential of wastes. When cleaned, the gas can be used in boilers at higher steam temperatures than in incinerators, or in internal combustion engines and gas turbine combined cycles.
- Waste gasification systems not applying gas cleaning before the combustion of the gas (two stage incineration) suffers from the same corrosion-related limitations in steam superheat temperature as conventional incinerators and can, at best, achieve efficiency similar to these. This efficiency of a conventional waste incinerator is also significantly lower than in other thermal power plants.
- However, incinerator economics are more relying on the revenue generated by accepting waste for treatment, i.e. the gate fee, than from selling energy. Therefore, in the absence of regulatory interventions setting more ambitious minimum efficiency targets, the drivers to increase the efficiency, even if present, are less pronounced than for conventional thermal power plants.
- Waste gasification technologies integrated with extensive gas cleaning can also produce synthesis gas for the production of fuels that can assist in the decarbonisation of the transport sector. This is an interesting application which also appears economically attractive compared to using waste to generate electric energy, and where there is no established technology to compete with.
- Conventional incineration technologies and waste gasification technologies alike must achieve a high level of contaminant removal to meet ever-more stringent statutory limiting emission values. Therefore, gasification technologies cannot be said to deliver major environmental benefits in terms of emissions compared to conventional technologies, even if there may be some cost advantages.
- The overall status of the gasification and gas cleaning technology is that it is still in development and entails both technical and non-technical risks. This also means that data regarding performance, availability, maintenance, investment and operating costs refers to first-of-a-kind installations representing a variety of gasification and gas cleaning technologies. The data is therefore limited and more difficult to generalise in comparison to data for conventional incineration technologies.
- Despite the technical and economic challenges for waste gasification technologies, a number of first-of-a-kind installations using different power cycles and fuel synthesis pathways are in early operation, commissioning, construction or in later stages of planning that together with others yet to come can assist in providing data to fill the knowledge gap.
- Policy interventions such as landfill bans or taxes are in general promoting the use of thermal treatment technologies, including gasification technologies, by increasing the availability of waste for thermal treatment, whereas waste prevention and recycling can reduce the waste quantities available, and therefore reduce the interest for innovative technologies. Setting high policy targets for the conversion efficiency or promoting the use of biofuels in transport would favour gasification technologies, due to their inherent high conversion efficiency and the possibility to produce fuels instead of just power and heat.



# 1. The scope and objective of this work

## 1.1. BACKGROUND

The primary scope and focus of IEA Biomass Agreement Task 33, "Thermal Gasification of Biomass", is to follow the developments in the area of biomass gasification with the purpose of providing a comprehensive source of information on activities in this field in the participating countries, but also outside of this group. To disseminate this information, apart from in meetings and workshops arranged by the Task, a dedicated web site is publicly available (<http://task33.ieabioenergy.com>).

Although the main focus, in terms of gasifier feedstocks, is material of biomass origin, also waste feedstocks are of interest. The reason for this is that some material normally considered as "wastes" are in fact biomass materials (e.g. forest industry process residues, sludges, food industry solid wastes, etc.), while other types of industrial and household wastes is to a large fraction composed of unprocessed or processed biomass materials. In addition, the combustible part of the non-biomass waste such as plastics, etc. have fuel characteristics (high volatile matter content, low fixed carbon content) and product gas characteristics (e.g. tar contamination) resembling the characteristics of biomass-derived gas, so that similar processing conditions and gas cleaning techniques can be used for waste gasification as is used for biomass gasification. However, despite these similarities with biomass, there are also some significant differences (e.g. a generally higher ash content and higher content of other contaminants) that generate some specific challenges when using wastes as a gasifier fuel.

For this reason, waste gasification is always to some extent included in the Task activities and from time to time, there have been more focused activities on this theme. Since in the recent years there has been a renewed interest in waste gasification to convert wastes into other energy carriers, including developments up to commercial scale in Canada, China, Europe, Japan and the USA, the Task has decided to include waste gasification as topic for a special project in the period 2016-2018.

As there are also other Tasks within the IEA Biomass Agreement that are addressing subjects and processes that are applied for wastes, the project has also involved contacts with mainly Task 36 "Integrating Energy Recovery into Solid Waste Management<sup>1</sup>".

## 1.2. MOTIVATION

Waste treatment is of high importance to all societies as it is linked to many other issues such as health, pollution of land, air and water as well as climate change and unsustainable resource utilization. The world's population is growing and as a consequence more wastes are generated from this alone, and changes in the life-style of this increasing population further adds to the waste generation while at the same time the composition and characteristics of the waste has changed through the introduction of plastics of various kind, largely being produced from fossil raw materials.

The disposal methods used of old such as of dumping it on some marginal land or in rivers or oceans that have been used for centuries have proven to generate a number of problems (methane emissions, soil and groundwater contamination, plastic soup in the oceans etc.). However, even if modern, controlled and engineered landfills is used, neither the material disposed of nor its energy content is recovered. Incineration has been seen as advantageous as it sanitizes the waste and greatly reduces the volume. But, even if more stringent air pollution control and ash disposal methods have improved the emission footprint and more or less sophisticated energy recovery is

---

<sup>1</sup> [task36.ieabioenergy.com](http://task36.ieabioenergy.com)

used, the products are limited to power and heat. As renewable energy is expanding these two products will increasingly be generated from other renewable sources at lower and lower. In this perspective waste gasification has some advantages, the efficiency to power can potentially be increased compared to conventional technologies and there is also the potential to produce chemicals and fuels that directly substitute fossil equivalents by producing an intermediate synthesis gas. Since society is striving towards sustainability, a "circular economy", where more extensive recycling and recovery of materials already within the societal ecology is promoted in order to reduce the need for replenishment from virgin resources, waste gasification has a special role. It is the only waste management technology that can process all organic material in wastes, both fossil and biogenic, into fuels and chemicals. Despite of being a problem involving of the order of 3 000 million tonnes annually in 2012 (and expected to double to 2025)<sup>2</sup>, and the energy potential is significant, however, this only amounts in energy terms to a few percent of the global energy balance and to 3 % of the GHG emissions<sup>3</sup>.

Gasification of waste has aroused considerable interest for at least the last forty years. In a review<sup>4</sup> made by Task 33 covering material up to 1996, more than forty developments were found. Many of these developments are no longer pursued. Some are still available on the market or are still subject to developments while several new developments have been added.

Over the years, the driving factors for using gasification technology have changed. Historically, the cited report concludes that the main drivers for thermal treatment of waste by incineration or gasification were the sanitization of waste and reduction of its volume prior to landfilling. Later, melting of the ash to reduce its leachability was seen to be of importance since conventional incinerators/combustors were not suitable to meet such requirements.

It has also been acknowledged for some time that if the gas produced was properly cleaned, there was and added value in that a cleaned gas is suitable for power generation with higher efficiency than for conventional incineration or, as mentioned above, for conversion to a synthesis gas for production of e.g. transport fuels.

Despite of these advantages, there have been difficulties in introducing waste gasification technologies into the market. Many processes used untreated municipal solid wastes (MSW) and suffered because of the heterogeneity of the feed material. Others had difficulties with the cleaning of the gas produced. To this should be added that until recently, and in most locations, the economic incentives for any form of waste-to-energy plant (WtE) have not been attractive compared to landfilling. Furthermore, conservatism combined with strict emission regulations and market conditions have not favoured the introduction of novel technologies.

Already in 1998, CADDET/IEA Bioenergy Task XIV concluded<sup>5</sup> that waste gasification technologies could give better efficiency to power and potentially also better environmental performance than combustion-based systems (waste incinerators), while also being very compatible with recycling operations. However, it was also concluded that at that time the drivers for any thermal treatment of wastes were weak and that documented data on reliability strongly favoured conventional technologies. The conclusion was that stronger statutory regulations to promote the introduction of novel and more efficient technologies were needed to drive the technology forward.

---

<sup>2</sup> World Energy Resources. Waste to Energy| 2016. World Energy Council, 2016.

<sup>3</sup> Mitigation of global greenhouse gas emissions from waste: conclusions and strategies from the Intergovernmental Panel on Climate Change (IPCC). Fourth Assessment Report. Working Group III (Mitigation). Jean Bogner *et al.* Waste Management & Research 2008: 26: 11–32,

Biomass Agreement. TASK X. BIOMASS UTILIZATION. BIOMASS THERMAL GASIFICATION AND GAS TURBINES ACTIVITY. Sub-task 6 - Gasification of Waste. Summary and Conclusions of Twenty-five Years of Development". Rensfelt E., TPS Termiska Processer AB, and Östman A., Kemiinformation AB. TPS Report 96/19

<sup>5</sup> Advanced Thermal Conversion Technologies for Solid Wastes". IEA CADDET, IEA Bioenergy Task XIV. 1998

Recent legal and policy actions, such as more stringent requirements on waste separation and recycling techniques, emission limits, targets for efficiency as well as economics, have to some extent provided such drivers for the introduction of gasification technologies based on the potential step-up in performance relative to the state-of-the-art of incineration technology. Incineration technologies are commercial in terms of their technical maturity and therefore expected improvements are only incremental relative to the state-of-the-art, whereas the gasification technologies, when more established, still have significant headspace to projected performances.

The interaction between policy and technology has also influenced the choice of waste treatment technologies. In Japan, the lack of space for landfills made waste incineration a preferred technology as early as in the 1970's. In 1998, one decisive policy intervention required new waste incineration plants to have ash melting facilities in order to reduce dioxin in fly ash and leaching from landfills. This triggered several developments making it the primary market for waste gasification technologies. However, the technologies employed in Japan had difficulties to penetrate the market in countries in Europe and USA. One reason for this was that energy production, i.e. a combination of efficiency and availability, has been much more important in these latter countries than in Japan. Another difference is the cost of landfilling that has historically been low elsewhere, at least compared to Japan. Furthermore, in some countries with high share of incineration relative to landfilling, conventional incinerators that co-generate district heating are common and the difference in the value between heat and power has been insufficient to drive developments towards an increase in the power output.

In the EU, stronger policy drivers are being introduced such as the ban on landfilling organic waste, the increased regulatory requirement for both energy and materials recovery efficiency as well as the promotion of efficient WtE plants. In some countries specific economic promotion schemes are in force. In the UK, waste gasification was included in the Renewable Obligation Certificate System and received two Renewable Order Certificates (ROCs) per MWh for units started until 2017, while conventional incineration technologies were not eligible for ROCs. In Norway, waste incineration/gasification is also included in the renewable certificate system.

Outside the conventional thermal conversion of wastes, the policies for decarbonization of the transport sector have recognized the potential for utilizing wastes for the production of transport fuels, waste-to-liquids (WtL), and this area has attracted some interest in the last decade. For this application, gasification is a key technology. In addition, and unlike WtE, for WtL there is no well-established competing conversion technology for gasification of wastes and biomass, such that the market introduction proceeds via waste and biomass gasification. WtL plants have been built in Canada and the USA, and still more are planned in the USA, utilizing government support in the form of loan guarantees and revenues based on the RFS (Renewable Fuel Standard) system.

Through regulatory interventions as exemplified above, sometimes also combined with other policy measures to divert wastes from landfills, the interest in waste gasification technologies is increased resulting in project plans that in some cases also materialize into installations. This includes both examples of technologies developed in the past that are now used for new applications and/or at a capacity scale not considered in the past and new developments.

Since there is no recent overview of the activities in this field and since the last overview by IEA Task 33 was made almost two decades ago, the Task has identified such a study to define the State-of-the-Art in this field as an activity of interest for several target groups including technologists, policy-makers and the interested public in general.

### **1.3. THE SCOPE OF THE STUDY**

The scope of the study is to give an overview of the use of waste gasification technologies, both from regulatory aspects and the applications. In the context of this study, "waste" has a broad definition that basically includes all types of combustible materials termed wastes or residues that are not defined as non-waste biomass, but with the exclusion of hazardous wastes. The reason for this exclusion is that the rationale for the process selection for hazardous waste processing is very different to the boundary conditions for treatment of municipal or industrial wastes, and that as an economic activity, products are less important than the reliable treatment of this type of waste.

To accept waste for treatment as a commercial activity is subjected to various legal and technical requirements. Within the scope of the study such regulations are highlighted in some settings (e.g. EU, Japan, USA) and the impact of these regulations for process design is discussed.

The market setting considered for the use of waste gasification is the diversion of waste from disposal in landfills while recovering the energy in the waste to other energy carriers (power, heat, gaseous fuel, synthesis gas to produce synthetic natural gas and liquid fuels, etc.) in various industrial applications. Also, other objectives are considered such as improving the overall energy efficiency and environmental performance relative to conventional incineration technologies, substitution of fossil fuels and improving the properties of secondary residues (ash, slag).

The processing of waste by various gasification procedures and the gas cleaning required for various applications are described and discussed. This relates to the generic gasification technologies used, their fuel requirements and performance.

Sometimes the term gasifier is used for a technology where none or a very limited part of the improvement potential of gasification technologies is realized, e.g. where no pre-combustion gas clean-up is applied. The relation between the use of partial or complete pre-combustion gas cleaning, and requirements for post-combustion flue gas cleaning, is discussed including the implications on the process performance as well as how these relate to the potential applications of the technology.

The report describes the State-of-the-Art in waste gasification, mainly for processes where pre-combustion cleaning is applied in some detail. This includes the description of specific process developments and their technology status, a listing of active developers in the field and their references. Furthermore, some recent projects taken into operation, or in construction, are highlighted to give an indication of the status and performance on emerging technologies for industrial deployment.

### **1.4. METHODOLOGY**

The methodology used for this study has mainly been to collect information from public sources. The data from such sources have been analysed to come to technical and other conclusions and have also been used to arrive at a list of technology developers/suppliers and waste gasification projects in various stages ranging from operational to planned. The changing nature of this market however also means that such a listing will never be complete, even when made, and also, over time, projects on the list will be completed or abandoned while new ones will emerge. This information is included as Appendix 3 and 4 in this report.

In addition, in the case of developers/suppliers that were judged to be more technically mature in terms of being involved in full scale gasification plants or projects, direct contacts were taken to obtain more information on the status of their respective technologies.

## 2. Wastes as a gasifier fuel

There are several ways of defining wastes. One way is to define the waste based on its origin; untreated wastes collected from households is typically referred to as municipal solid wastes, MSW. There are also industrial wastes (IW), commercial wastes (CW), construction and demolition wastes (CDW), and shredder light fraction (SRF). Another way is to base the classification on the properties, e.g. inert wastes, organic wastes, combustible wastes, and non-hazardous wastes and hazardous wastes (HW, the treatment of which is outside of the scope of this report).

IW and CDW are typically composed of inert materials (soil, ore refining sand, concrete, bricks etc.), or metallic and liquid wastes, and only a fraction is combustible.

From a fuel perspective, unsorted fuels like e.g. MSW can be used in waste incinerators, and then typically in grate firing systems. By letting unsorted waste pass a mechanical and biological treatment (MBT) installation, recyclable materials are recovered, inerts separated and wet organic waste removed for separate treatment by composting or anaerobic digestion. The remaining wastes, the reject fraction, has an increased energy content, lower moisture and less non-combustibles and is typically termed RDF, refuse derived fuel. However, there is typically no specific quality requirements on RDF (for exceptions see below). However, if the sourcing of the feedstock and the treatment is done to provide a validated and stable set of quality parameters, RDF can be classified as SRF, solid recovered fuel. This does not mean that the SRF has met end-of-waste criteria, it only means that the material fulfils certain descriptive quality criteria in a number of classes, see also Section 2.2.

### 2.1. WASTE FUEL CHARACTERISTICS

The main characteristics of waste fuels is the variability. This variability stems from many factors, including seasonal variations, socio-economics of the waste uptake area, collection practices and the waste treatment by mechanical and other treatment methods prior to its use as fuel. Since all these factors also change over time (e.g. as the income goes up the waste tend to have less organic content and more packaging materials), the increased use of source separation and recycling provides a fuel with less inerts and less moisture, etc. Although there are many examples of published data on the analysis of wastes, these are typically applied to characterize wastes for a specific purpose such as e.g. laboratory tests, etc., or to characterize wastes over a certain period of time in a specific area. The data may in the latter case be in terms of the physical constituents such as organic material, paper, plastics, etc. and not associated with a chemical analysis. Furthermore, even when performing analyses, the full panoply of analyses is often not included. Therefore, it is difficult to generalize on the properties of wastes.

Nevertheless, in Table 1 and Table 2 some published data of the chemical composition of a more general nature are found, but unfortunately not with the same scope of analyses. These stem from the 2006 EC WID BREF data for Germany 2001-2002<sup>6</sup>., surveys in Sweden 2011-2012<sup>7</sup> on the locally used MSW/RDF and RDF imported from the UK as well as the data available in the Phyllis<sup>28</sup> database of ECN part of TNO. In the latter case, the nature and origin of the samples analysed are not defined.

As can be seen, there is a wide range in the content of non-combustibles (moisture and ash

<sup>6</sup> Integrated Pollution Prevention and Control. Reference Document on the Best Available Techniques for Waste Incineration. European Commission. August 2006

<sup>7</sup> Bränslekvalitet. - Sammansättning och egenskaper för avfallsbränsle till energiåtervinning. Mattias Bisailon, Inge Johansson, Frida Jones, Jenny Sahlin. Projektnummer WR-57, 2013. WASTE REFINERY. SP Sveriges Tekniska Forskningsinstitut. Borås, Sweden

<sup>8</sup> www.phyllis.nl

content) but also in other properties. When it comes to the trace components, unfortunately these have often not been analysed, or only very few of these components were analysed, such that variability in trace components cannot be relevantly addressed using this data.

**Table 1 Compiled analyses of MSW and RDF**

	<b>MSW, Germany, 2001-2002<sup>6</sup></b>	<b>Average MSW/RDF fuel, Sweden, 2011<sup>7</sup>. (42 samples, 6 each from 7 WtE plants in different regions) Average (Min-Max)</b>	<b>RDF imported to Sweden from the UK, 2011-2012<sup>7</sup>. (34 samples from 6 WtE plants) Average (Min-Max)</b>
<b>Gross Calorific value (MJ/kg)</b>	7-15	n.a.	n.a.
<b>Net Calorific value (MJ/kg)</b>	6-14.6 est.	11 (8.3-15)	13 (9.7-17)
<b>Water %</b>	15-40	38 (22-48)	32 (17-46)
<b>Ash</b>	20-35	21 (13-40)	(10 4.8-19)
<b>Carbon (% d.s.)</b>	18-40	n.a.	n.a.
<b>Hydrogen (% d.s.)</b>	1-5	n.a.	n.a.
<b>Nitrogen (% d.s.)</b>	0.2-1.5	n.a.	n.a.
<b>Oxygen (% d.s.) by bal.</b>	15-22	n.a.	n.a.
<b>Sulphur (% d.s.)</b>	0.1-0.5	0.37 (0.09-0.86)	0.13 (0.04-0.80)
<b>Fluorine (% d.s.)</b>	0.035-0.1	n.a.	n.a.
<b>Chlorine (% d.s.)</b>	0.1-1	0.78 (0.03-1.4)	0.38 (0.04-2.6)
<b>Bromine (% d.s.)</b>	n.a.	n.a.	n.a.
<b>Iodine (% d.s.)</b>	n.a.	n.a.	n.a.
<b>Potassium (mg/kg d.s.)</b>	n.a.	0.36 (0.17-0.59)	0.25 (0.22-0.29)
<b>Lead (mg/kg d.s.)</b>	100-2 000	n.a.	n.a.
<b>Cadmium (mg/kg d.s.)</b>	1-15	2.3 (0.2-16.0)	0.30 (0.07-0.98)
<b>Copper (mg/kg d.s.)</b>	200-700	n.a.	n.a.
<b>Zinc (mg/kg d.s.)</b>	400-1400	800 (250-1900)	98 (17-480)
<b>Mercury (mg/kg d.s.)</b>	1-5	0.50 (0.12-0.95)	0.14 (0.05-0.50)
<b>Thallium (mg/kg d.s.)</b>	< 0.1	n.a.	n.a.
<b>Manganese (mg/kg d.s.)</b>	250	n.a.	n.a.
<b>Vanadium (mg/kg d.s.)</b>	4-11	n.a.	n.a.
<b>Nickel (mg/kg d.s.)</b>	30-50	n.a.	n.a.
<b>Cobalt (mg/kg d.s.)</b>	3-10	n.a.	n.a.
<b>Arsenic (mg/kg d.s.)</b>	2-5	n.a.	n.a.
<b>Chrome (mg/kg d.s.)</b>	40-200	n.a.	n.a.
<b>Selenium (mg/kg d.s.)</b>	0.2-15	n.a.	n.a.
<b>PCB (mg/kg d.s.)</b>	0.2-0.4	n.a.	n.a.
<b>PCDD/PCDF (ng I-TE/kg)</b>	50-250	n.a.	n.a.

**Table 2 RDF and SRF analyses from Phyllis<sup>2</sup>**

Phyllis 2 Database <sup>8</sup>  N denotes number of samples	RDF, 16 samples in total				SRF, 17 samples in total			
	Mean	Min.	Max.	N	Mean	Min.	Max.	N
<b>Net CV MJ/kg (daf)</b>	21.54	16.13	27.80	16	25.33	18.96	32.46	17
<b>Gross CV MJ/kg (daf)</b>	22.72	17.40	26.57	15	27.10	20.28	34.75	17
<b>Moisture cont. wt.%</b>	13.12	2.82	38.70	10	28.46	1.90	59.00	13
<b>Ash cont. wt.% (dry)</b>	17.47	9.30	27.72	14	8.27	4.90	10.90	7
<b>C wt.% (daf)</b>	52.11	42.50	61.62	16	61.74	51.49	75.56	12
<b>H wt.% (daf)</b>	7.40	5.84	8.91	16	8.42	6.08	10.73	13
<b>N wt.% (daf)</b>	0.85	0.31	1.49	15	0.52	0.10	2.18	17
<b>S wt.% (daf)</b>	0.46	0.12	0.98	14	0.14	0.02	0.42	17
<b>O wt.% (daf)</b>	37.06	24.60	43.73	16	32.47	30.60	35.02	4
<b>Cl mg/kg (daf)</b>	7 265	55.0	14 341	14	0.5	0.5	0.5	1
<b>Br mg/kg (daf)</b>	50.1	50.1	50.1	1	n.a.	n.a.	n.a.	0
<b>F mg/kg (daf)</b>	88.2	88.0	88.5	2	n.a.	n.a.	n.a.	0
<b>Al mg/kg (dry)</b>	5 201	1 600	7 300	3	n.a.	n.a.	n.a.	0
<b>K mg/kg (dry)</b>	1 593	1 364	1 823	2	n.a.	n.a.	n.a.	0
<b>Na mg/kg (dry)</b>	2 772	2 590	2 955	2	n.a.	n.a.	n.a.	0
<b>Ca mg/kg (dry)</b>	23 915	21 936	25 895	2	n.a.	n.a.	n.a.	0
<b>Si mg/kg (dry)</b>	18 272	9 641	26 903	2	n.a.	n.a.	n.a.	0
<b>Mg mg/kg (dry)</b>	1 688	1 410	1 966	2	n.a.	n.a.	n.a.	0
<b>Fe mg/kg (dry)</b>	2 477	768	4 689	3	n.a.	n.a.	n.a.	0
<b>P mg/kg (dry)</b>	379	279	480	2	n.a.	n.a.	n.a.	0
<b>Ti mg/kg (dry)</b>	1 359	1 063	1 654	2	n.a.	n.a.	n.a.	0
<b>As mg/kg (dry)</b>	6.4	5.0	9.0	3	n.a.	n.a.	n.a.	0
<b>Cd mg/kg (dry)</b>	1.9	0.8	3.0	2	n.a.	n.a.	n.a.	0
<b>Co mg/kg (dry)</b>	5.6	4.2	7.0	2	n.a.	n.a.	n.a.	0
<b>Cr mg/kg (dry)</b>	168.4	8.0	429.0	3	n.a.	n.a.	n.a.	0
<b>Cu mg/kg (dry)</b>	386.0	35.0	610.0	3	n.a.	n.a.	n.a.	0
<b>Mn mg/kg (dry)</b>	83.2	57.0	126.0	3	n.a.	n.a.	n.a.	0
<b>Ni mg/kg (dry)</b>	100.3	2.0	266.0	3	n.a.	n.a.	n.a.	0
<b>Pb mg/kg (dry)</b>	134.4	50.0	260.0	3	n.a.	n.a.	n.a.	0
<b>V mg/kg (dry)</b>	4.7	3.1	7.0	3	n.a.	n.a.	n.a.	0
<b>Zn mg/kg (dry)</b>	232.1	85.0	393.0	3	n.a.	n.a.	n.a.	0
<b>Ba mg/kg (dry)</b>	341.7	142.4	541.0	2	n.a.	n.a.	n.a.	0
<b>Mo mg/kg (dry)</b>	9.2	1.4	17.0	2	n.a.	n.a.	n.a.	0
<b>Se mg/kg (dry)</b>	0.3	0.3	0.3	1	n.a.	n.a.	n.a.	0
<b>Hg mg/kg (dry)</b>	0.2	0.2	0.2	1	n.a.	n.a.	n.a.	0
<b>Sn mg/kg (dry)</b>	20.1	17.0	23.1	2	n.a.	n.a.	n.a.	0
<b>Sr mg/kg (dry)</b>	103.3	63.5	143.0	2	n.a.	n.a.	n.a.	0
<b>B mg/kg (dry)</b>	63.1	44.2	82.0	2	n.a.	n.a.	n.a.	0
<b>Sb mg/kg (dry)</b>	45.0	29.0	61.0	2	n.a.	n.a.	n.a.	0

There are also wide variations in the net calorific value of the fuels actually fired, Figure 1 and Figure 2. The basis of the data is 314 plants in the EU in the period 2007-2010. The as-fired fuels range from just above 6 to 17 MJ/kg, with an average of 10.4 MJ/kg. The lower and upper quartile of the number of plants range from 8.8 MJ/kg to 11.8 MJ/kg. In Figure 2, it can be seen that the variation between plants of different types (power, heat only and CHP) and plant capacity is not so large, but that fuels used in northern Europe has a higher energy content than is the case in central and southern Europe.

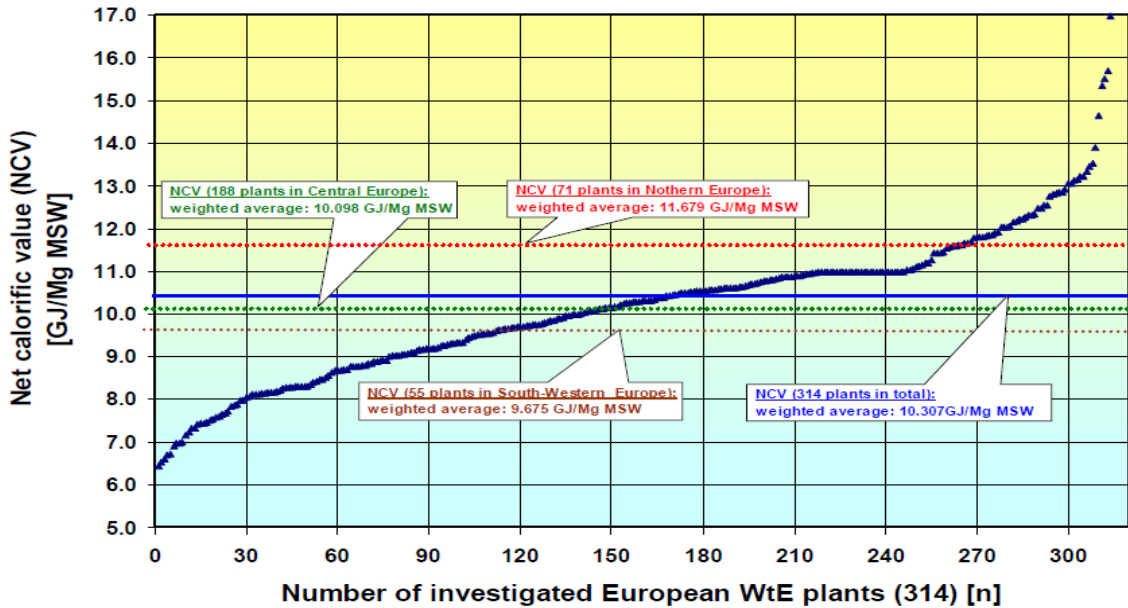

**Figure 1** The NCV of waste fired in 2007-2010 in 314 WtE plants in the EU<sup>9</sup>

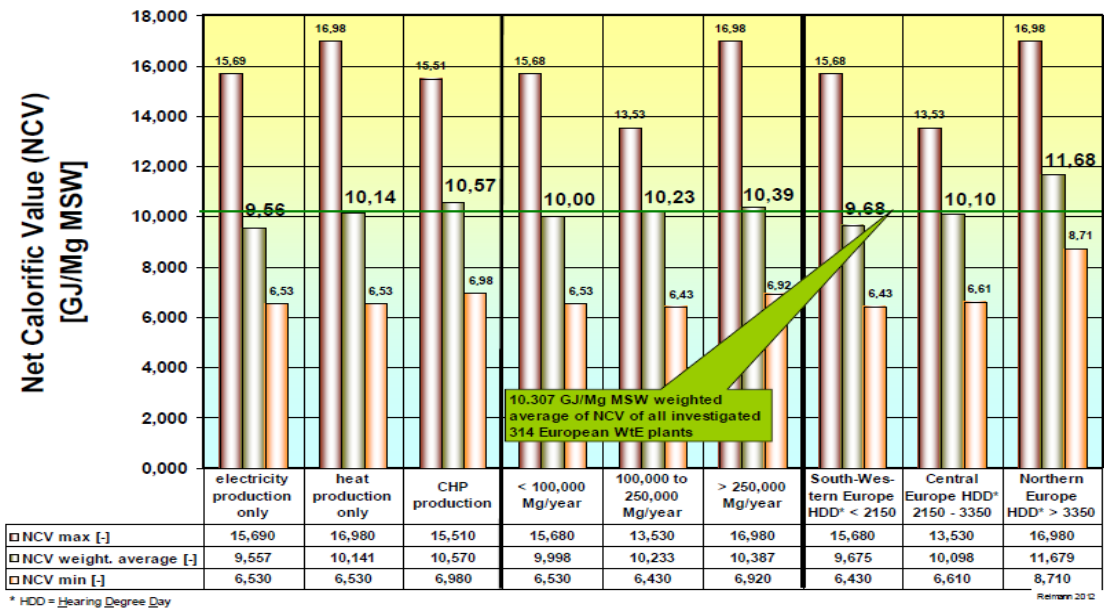

**Figure 2** The NCV of waste fired in 2007-2010 in 314 WtE plants in the EU, grouped according to type of plant, capacity and location, respectively<sup>9</sup>.

<sup>9</sup> CEWEP Energy Report III (Status 2007-2010). D. O. Reiman. CEWEP December 2013



## 2.2. WASTE FUEL STANDARDS

Over the years there have been a number of attempts to classify wastes according to some standards. Below is an overview of the these and also on the current on-going work in defining standards for SRF.

### 2.2.1. CEN/TC292 -Waste characterization

The scope of CEN/TC 292 is the standardization of procedures to sample and determine the characteristics of waste and waste behaviour, especially leaching properties and standardization of subsequent terminology. In Appendix 1, Table A1.1 some outputs from this technical committee are listed.

### 2.2.2. RDF standards

As was explained above, RDF is the reject fraction of a mechanical and biological treatment (MBT) facility, and which is intended for use as a fuel. This, however, does not mean that RDF has specific defined characteristics. To suit the needs of the waste industry, and prior to other forms of classifications and the introduction of the SRF definition and standards, there have been several attempts to define and standardize RDF on a national basis in Austria, Table 3, as well as in Germany, Finland and Italy, see Table 4 as a fuel for incineration or co-incineration. However, such standards often preceded other standardisation efforts and are now subordinated to common EU legislation, i.e. cannot be interpreted as e.g. end-of-waste criteria.

**Table 3 Legal requirements for end-of-waste use of RDF in Austria<sup>10</sup>**

Metal	Limiting value mg/MJ							
	Cement kilns		Co-firing				Co-combustion	
			≤ 10% of total energy		≤ 15% of total energy			
	Median	80:th percentile	Median	80:th percentile	Median	80:th percentile	Median	80:th percentile
<b>Sb</b>	7	10	7	10	7	10	7	10
<b>As</b>	2	3	2	3	2	3	1	1,5
<b>Pb</b>	20	36	23	41	15	27	15	27
<b>Cd</b>	0,23	0,46	0,27	0,54	0,17	0,34	0,17	0,34
<b>Cr</b>	25	37	31	46	19	28	19	28
<b>Co</b>	1,5	2,7	1,4	2,5	0,9	1,6	0,9	1,6
<b>Ni</b>	10	18	11	19	7	12	7	12
<b>Hg</b>	0,075	0,15	0,075	0,15	0,075	0,15	0,075	0,15

In England, Department for Environment, Food & Rural Affairs (Defra) and the environmental agency (EA) had in 2014 the intention of introducing a standard for the treatment required to qualify as RDF to ensure that waste pre-treatment was sufficiently efficient to meet the needs of the incinerator industry, and also to ensure that export of RDF was not done to lesser standards than would otherwise be required<sup>11</sup>. However, after public and industrial consultations, proving that there were a number of treatment options used that would make it impractical to prescribe technical treatment requirements of RDF characteristics, instead a definition for RDF was introduced:

<sup>10</sup> BMLFUW – Bundesministerium für Land- und Forstwirtschaft, Umwelt und Wasserwirtschaft (ed.) (2010) Verordnung über die Verbrennung von Abfällen – Abfallverbrennungsverordnung – AVV

<sup>11</sup> Refuse derived fuel market in England Defra response to the call for evidence. Defra, December 2014

"Refuse derived fuel (RDF) consists of residual waste that complies with the specifications in a written contract between the producer of the RDF and a permitted end-user for the thermal treatment of the waste in an energy from waste facility or a facility undertaking co-incineration such as cement and lime kilns. The written contract must include the end user's technical specifications relating as a minimum to the calorific value, the moisture content, the form and quantity of the RDF"<sup>12</sup>.

**Table 4 Overview of limit values for existing European RDF quality standards<sup>13</sup>**

Parameter	Units	Germany		Finland		Italy			EURITS / Flemish region of Belgium <sup>††</sup>	
		Median	80 <sup>th</sup> percentile	Class I	Class II	Class III	(2006) Standard quality (CDR)	(1998) Standard quality UNI 9903		(1998) High quality UNI 9903
Ash content	% %/w d	***					<15	<20	<15	5 **
Moisture content MC	% %/w ar	***					<18	<25	<15	
Net calorific value Q <sub>p,net</sub>	MJ kg <sup>-1</sup> ar	***†					>20	>15 min value	>19 min value	>15
Aluminium (metallic) (Al)	% %/w ††			†††	††	††				
Antimony (Sb)	mg kg <sup>-1</sup> d	50 †††	120 †††							
Arsenic (As)	mg kg <sup>-1</sup> d	5 †††	13 †††				<5	<9		
Beryllium (Be)	mg kg <sup>-1</sup>									<1
Bromine (Br)/Iodine (I)	% %/w									<0.01
Cadmium (Cd)	mg kg <sup>-1</sup> d	4 †††	9 †††	<1.0	<4.0	<5.0	<3	<7 Hg+Cd	<1 Hg+Cd	
Chlorine (Cl)	% %/w d	***		<0.15	<0.5	<1.5	<0.7	<0.9% ar	<0.7% ar	<0.5
Chromium (Cr)	mg kg <sup>-1</sup> d	125 †††	250 †††				<70	<100		
Cobalt (Co)	mg/kg d	6 †††	12 †††							
Copper (Cu)	mg kg <sup>-1</sup> d	350 †††	***				<50 soluble	<300 soluble	<50 soluble	
Fluorine (F)	% %/w									<0.1
Lead (Pb)	mg kg <sup>-1</sup> d	190 †††	***				<100 volatile	<200 volatile	<400	
Manganese (Mn)	mg kg <sup>-1</sup> d	250 †††	500 †††							20
Mercury (Hg)	mg kg <sup>-1</sup> d	0.6 †††	1.2 †††	<0.1	<0.2	<0.5	<1			<2
Molybdenum (Mo)	mg kg <sup>-1</sup> d									
Nickel (Ni)	mg kg <sup>-1</sup> d	80 †††	160 †††				<30	<40		
Nitrogen (N)	% %/w ††			<1.00	<1.50	<2.50				0.7
Sum potassium and sodium (K+Na) †††	% %/w d			<0.2	<0.4	<0.5				
Sulphur (S)	% %/w ††			<0.20	<0.30	<0.50	<0.3 d	<0.6 ar	<350	0.4
Sum HM	mg/kg d	1049	2460					<1040		
Thalium (Tl)	mg kg <sup>-1</sup> d	1 †††	2 †††							<2
Vanadium (V)	mg kg <sup>-1</sup> d	10 †††	25 †††							
Zinc (Zn)	mg kg <sup>-1</sup>									500
As,Se,(Te),Cd,Sb <sup>‡</sup>	mg kg <sup>-1</sup>									10
V,Cr,Co,Ni,Cu,Pb,Mn,Sn	mg kg <sup>-1</sup>									200

† Decimal points denote the necessary precision of detection. Classification limits apply to a volume of SRF ≤1000 m<sup>3</sup> or to the volume produced or delivered during one month

†† Excluding: Ca, Al, Fe, Si. Arbitrary value

††† These process-specific parameters should be documented for the purposes of QA/QC: limits specified by each particular end-user contract apply

† Both MJ kg<sup>-1</sup> d and MJ kg<sup>-1</sup> ar should be reported

†† Values result from calculations based on certain assumptions. Refer to publication for details. Necessary basis of report (ar or d) not stated

††† Metallic Al is not allowed, but accepted within the limits of reporting precision (0.01)

†††† Metallic Al is removed/minimised by source-separation and by the SRF production process

††††† Metallic Al content is agreed separately

†††† German values apply to the high-calorific value fractions derived from municipal waste. HM content values are valid as from a NCV of ≥16 MJ kg<sup>-1</sup> d. For calorific values falling below, the above-mentioned values need to be accordingly lowered linearly; an increase is not allowed

††††† Definition only on the basis of a reliable dataset from the SRF production process

†††††† Total content (K+Na) of water-soluble and ion-exchangeable proportion

‡ Limit values apply to each of the metal separately

### 2.2.3. CEN/TC 343 - SRF standards

The scope of CEN/TC 343 is Solid Recovered Fuel (SRF), a "solid fuel prepared from non-hazardous waste to be utilised for energy recovery in incineration or co-incineration plants and meeting the classification and the specification requirements laid down in EN15359". The SRF is produced from

<sup>12</sup> Refuse Derived Fuel Code of Practice for the UK, RDF Industry Group, October 2017,

<sup>13</sup> Production and quality assurance of solid recovered fuels using mechanical biological treatment (MBT) of waste: a comprehensive assessment, C.A. Velis *et al.* Critical Reviews in Environmental Science and Technology, 40, 12, 2010, Pages 979-1105.

non-hazardous waste according to a quality management system defined by EN15358. After the production process it fulfils certain criteria at the producer/user interface, Figure 3.

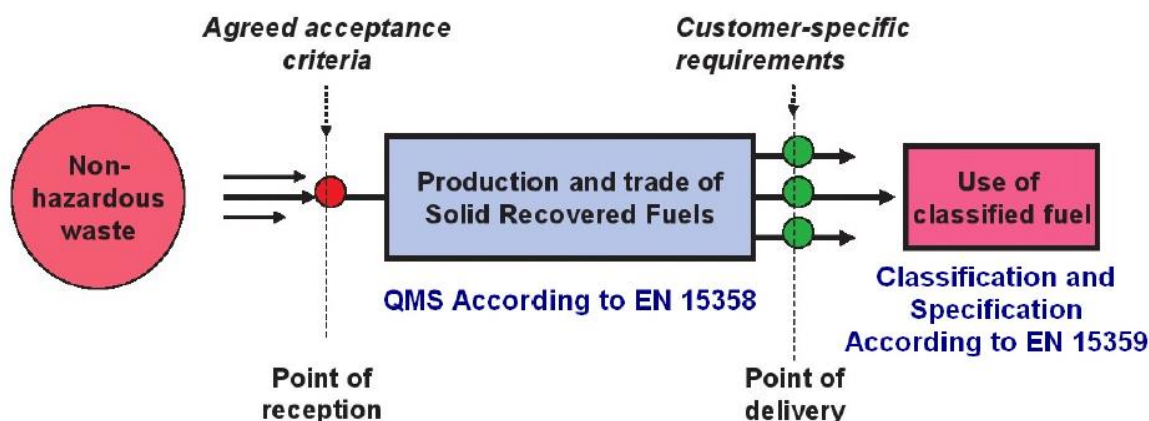

**Figure 3** Solid recovered fuel chain. The classification and specification apply at the point of delivery

The classification is based on the calorific value, the chlorine content and the mercury content, Table 5. This leads to a characterisation code such as e.g. NCV 2 Cl 3 Hg1 or 2,3,1.

**Table 5** SRF classification according to EN15359

Parameter	Statistical entity	Unit	Class				
			1	2	3	4	5
<b>NCV</b>	<b>Mean</b>	MJ/kg (ar)	$\geq 25$	$\geq 20$	$\geq 15$	$\geq 10$	$\geq 3$
<b>Cl</b>	<b>Mean</b>	% dry basis	$\leq 0,2$	$\leq 0,6$	$\leq 1,0$	$\leq 1,5$	$\leq 3,0$
<b>Hg</b>	<b>Median</b>	mg/MJ (ar)	$\leq 0,02$	$\leq 0,03$	$\leq 0,08$	$\leq 0,15$	$\leq 0,50$
	<b>80 percentile</b>	mg/MJ (ar)	$\leq 0,04$	$\leq 0,06$	$\leq 0,16$	$\leq 0,30$	$\leq 1,00$

In addition, also other characteristics of the fuel should be reported on a specification data sheet both on a compulsory and voluntary basis, Table 6.

One extremely important feature of this standard is the sampling and analytical procedure. This starts by defining a sample "lot", which is seen as the annual production over 12 months divided by ten, or 1 500 tons, whichever is the smaller quantity. From each lot, a minimum of 24 samples should be taken and combined to a gross sample, and from which a general sample is extracted that is further reduced into 4 samples, of which one is analysed for the three classes and two other samples for mercury only, while the fourth sample is stored. To determine the classification, at least 10 analyses, or 10 analyses per year, are required, depending on the situation. At the start of processing and when changes are made in the processing or feed material, additional gross samples can be taken from the same lot to determine the classification at an early stage. The sampling process is illustrated in Figure 4.

The procedure for the sampling of this highly heterogeneous material is an important aspect of determining the classification. A standard, EN 15442, details how the sampling and sample reduction procedure should be performed.

**Table 6 Specification template EN15359**

SRF class and origin			SRF origin and preparation		
Class code <sup>1</sup>			Preparation Level		
Origin <sup>1</sup>			1	2	3
<b>Physical parameters</b>			<input type="checkbox"/> Manual sorting <input type="checkbox"/> Mechanical sorting <input type="checkbox"/> Biological treatment <input type="checkbox"/> Chemical treatment <input type="checkbox"/> Other		
Particle form <sup>5</sup>	Test method		<input type="checkbox"/> Manual sorting <input type="checkbox"/> Mechanical sorting <input type="checkbox"/> Biological treatment <input type="checkbox"/> Chemical treatment <input type="checkbox"/> Other		
Particle size <sup>4</sup>	Unit	Value <sup>6</sup>	<input type="checkbox"/> Manual sorting <input type="checkbox"/> Mechanical sorting <input type="checkbox"/> Biological treatment <input type="checkbox"/> Chemical treatment <input type="checkbox"/> Other		
Asph content	% of	Limit	<input type="checkbox"/> Manual sorting <input type="checkbox"/> Mechanical sorting <input type="checkbox"/> Biological treatment <input type="checkbox"/> Chemical treatment <input type="checkbox"/> Other		
Moisture content	% of	Limit	<input type="checkbox"/> Manual sorting <input type="checkbox"/> Mechanical sorting <input type="checkbox"/> Biological treatment <input type="checkbox"/> Chemical treatment <input type="checkbox"/> Other		
Net calorific value	MJ/kg d.f.	Limit	<input type="checkbox"/> Manual sorting <input type="checkbox"/> Mechanical sorting <input type="checkbox"/> Biological treatment <input type="checkbox"/> Chemical treatment <input type="checkbox"/> Other		
Net calorific value	MJ/kg d.f.	Limit	<input type="checkbox"/> Manual sorting <input type="checkbox"/> Mechanical sorting <input type="checkbox"/> Biological treatment <input type="checkbox"/> Chemical treatment <input type="checkbox"/> Other		
<b>Chemical parameters</b>			<input type="checkbox"/> Manual sorting <input type="checkbox"/> Mechanical sorting <input type="checkbox"/> Biological treatment <input type="checkbox"/> Chemical treatment <input type="checkbox"/> Other		
Chlorine (Cl)	% of	Typical	Limit	<input type="checkbox"/> Manual sorting <input type="checkbox"/> Mechanical sorting <input type="checkbox"/> Biological treatment <input type="checkbox"/> Chemical treatment <input type="checkbox"/> Other	
Antimony (Sb)	mg/kg d	Typical	Limit	<input type="checkbox"/> Manual sorting <input type="checkbox"/> Mechanical sorting <input type="checkbox"/> Biological treatment <input type="checkbox"/> Chemical treatment <input type="checkbox"/> Other	
Bromine (Br)	mg/kg d	Typical	Limit	<input type="checkbox"/> Manual sorting <input type="checkbox"/> Mechanical sorting <input type="checkbox"/> Biological treatment <input type="checkbox"/> Chemical treatment <input type="checkbox"/> Other	
Chromium (Cr)	mg/kg d	Typical	Limit	<input type="checkbox"/> Manual sorting <input type="checkbox"/> Mechanical sorting <input type="checkbox"/> Biological treatment <input type="checkbox"/> Chemical treatment <input type="checkbox"/> Other	
Cobalt (Co)	mg/kg d	Typical	Limit	<input type="checkbox"/> Manual sorting <input type="checkbox"/> Mechanical sorting <input type="checkbox"/> Biological treatment <input type="checkbox"/> Chemical treatment <input type="checkbox"/> Other	
Copper (Cu)	mg/kg d	Typical	Limit	<input type="checkbox"/> Manual sorting <input type="checkbox"/> Mechanical sorting <input type="checkbox"/> Biological treatment <input type="checkbox"/> Chemical treatment <input type="checkbox"/> Other	
Lead (Pb)	mg/kg d	Typical	Limit	<input type="checkbox"/> Manual sorting <input type="checkbox"/> Mechanical sorting <input type="checkbox"/> Biological treatment <input type="checkbox"/> Chemical treatment <input type="checkbox"/> Other	
Manganese (Mn)	mg/kg d	Typical	Limit	<input type="checkbox"/> Manual sorting <input type="checkbox"/> Mechanical sorting <input type="checkbox"/> Biological treatment <input type="checkbox"/> Chemical treatment <input type="checkbox"/> Other	
Mercury (Hg)	mg/kg d	Typical	Limit	<input type="checkbox"/> Manual sorting <input type="checkbox"/> Mechanical sorting <input type="checkbox"/> Biological treatment <input type="checkbox"/> Chemical treatment <input type="checkbox"/> Other	
Nickel (Ni)	mg/kg d	Typical	Limit	<input type="checkbox"/> Manual sorting <input type="checkbox"/> Mechanical sorting <input type="checkbox"/> Biological treatment <input type="checkbox"/> Chemical treatment <input type="checkbox"/> Other	
Thallium (Tl)	mg/kg d	Typical	Limit	<input type="checkbox"/> Manual sorting <input type="checkbox"/> Mechanical sorting <input type="checkbox"/> Biological treatment <input type="checkbox"/> Chemical treatment <input type="checkbox"/> Other	
Vanadium (V)	mg/kg d	Typical	Limit	<input type="checkbox"/> Manual sorting <input type="checkbox"/> Mechanical sorting <input type="checkbox"/> Biological treatment <input type="checkbox"/> Chemical treatment <input type="checkbox"/> Other	
Zinc (Zn)	mg/kg d	Typical	Limit	<input type="checkbox"/> Manual sorting <input type="checkbox"/> Mechanical sorting <input type="checkbox"/> Biological treatment <input type="checkbox"/> Chemical treatment <input type="checkbox"/> Other	
<p><b>Obligatory to specify</b></p> <p>1 According to the class system as specified in Column 1.</p> <p>2 Referable to European Waste List (EWL) codes 4 or 8 plus code ' for residues and blends a combination of codes can be used.</p> <p>3 Examples of forms are pellets, bales, briquettes, flakes, chips, powder, fuel.</p> <p>4 By sorting or other methods, determined on a volume of 1 m<sup>3</sup> of the particle size on the distribution curve where 1 percent remains.</p> <p>5 The typical value is the mean value for the residue value if appropriate with respect to the distribution of the SRF over an agreed or specified period of time. The limit value (maximum, minimum or 95<sup>th</sup> percentile) if appropriate with respect to the distribution of the SRF will be agreed upon and defined by the user and producer, and refers to a component.</p> <p>6 The heavy metals in the sum are those listed above (Pb, Cr, Ni, and Cu) and exclude those in the Heavy Metals Directive (HMD).</p>					
<b>Voluntarily to specify</b>					
<p>1 Fuel preparation <sup>1</sup></p> <p>2 Biomass content</p> <p>3 Composition</p> <p>4 By mass <input type="checkbox"/></p> <p>5 As received <input type="checkbox"/></p> <p>6 Specification of other</p> <p>7 Physical parameters</p> <p>8 Ash density (content of vol. water)</p> <p>9 Ash melting behaviour</p> <p>10 Chemical parameters</p> <p>11 Major elements</p> <p>12 Trace elements</p> <p>13 According to EN Technical Specification, Annex D</p> <p>14 According to specific user (in brackets)</p> <p>15 The typical value is the mean value for the residue value if appropriate with respect to the distribution of the SRF over a period of time. The limit value (maximum, minimum or 95<sup>th</sup> percentile) if appropriate with respect to the distribution of the SRF will be agreed upon and defined by the user and producer, and refers to a component.</p>					
<p>10 Chemical parameters</p> <p>11 Major elements</p> <p>12 Trace elements</p> <p>13 According to EN Technical Specification, Annex D</p> <p>14 According to specific user (in brackets)</p> <p>15 The typical value is the mean value for the residue value if appropriate with respect to the distribution of the SRF over a period of time. The limit value (maximum, minimum or 95<sup>th</sup> percentile) if appropriate with respect to the distribution of the SRF will be agreed upon and defined by the user and producer, and refers to a component.</p>					
<p>16 Preparation Level</p> <p>17 Manual sorting</p> <p>18 Mechanical sorting</p> <p>19 Biological treatment</p> <p>20 Chemical treatment</p> <p>21 Other</p> <p>22 Ash density (content of vol. water)</p> <p>23 Ash melting behaviour</p> <p>24 Chemical parameters</p> <p>25 Major elements</p> <p>26 Trace elements</p> <p>27 According to EN Technical Specification, Annex D</p> <p>28 According to specific user (in brackets)</p> <p>29 The typical value is the mean value for the residue value if appropriate with respect to the distribution of the SRF over a period of time. The limit value (maximum, minimum or 95<sup>th</sup> percentile) if appropriate with respect to the distribution of the SRF will be agreed upon and defined by the user and producer, and refers to a component.</p>					
<p>30 Screening</p> <p>31 Washing</p> <p>32 Drying, cooling</p> <p>33 Biogasification</p> <p>34 Composting</p> <p>35 Other parameters</p> <p>36 Manual sorting</p> <p>37 Mechanical sorting</p> <p>38 Biological treatment</p> <p>39 Chemical treatment</p> <p>40 Other</p> <p>41 Ash density (content of vol. water)</p> <p>42 Ash melting behaviour</p> <p>43 Chemical parameters</p> <p>44 Major elements</p> <p>45 Trace elements</p> <p>46 According to EN Technical Specification, Annex D</p> <p>47 According to specific user (in brackets)</p> <p>48 The typical value is the mean value for the residue value if appropriate with respect to the distribution of the SRF over a period of time. The limit value (maximum, minimum or 95<sup>th</sup> percentile) if appropriate with respect to the distribution of the SRF will be agreed upon and defined by the user and producer, and refers to a component.</p>					

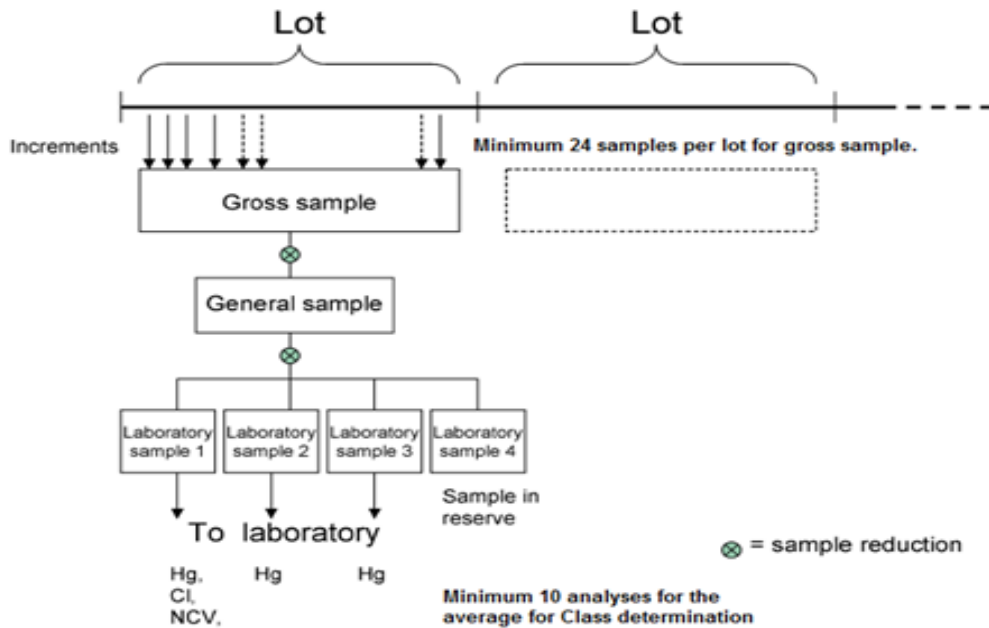

**Figure 4 Illustration of sampling and sample procedures according to EN15359.**

The gross sample is defined as a mathematical function of the largest particle size ( $d_{95}$ ), shape and particle and bulk density, plus the variability in the presence of contaminants content in certain particles, etc., but can also be defined by the production capacity, Figure 5.

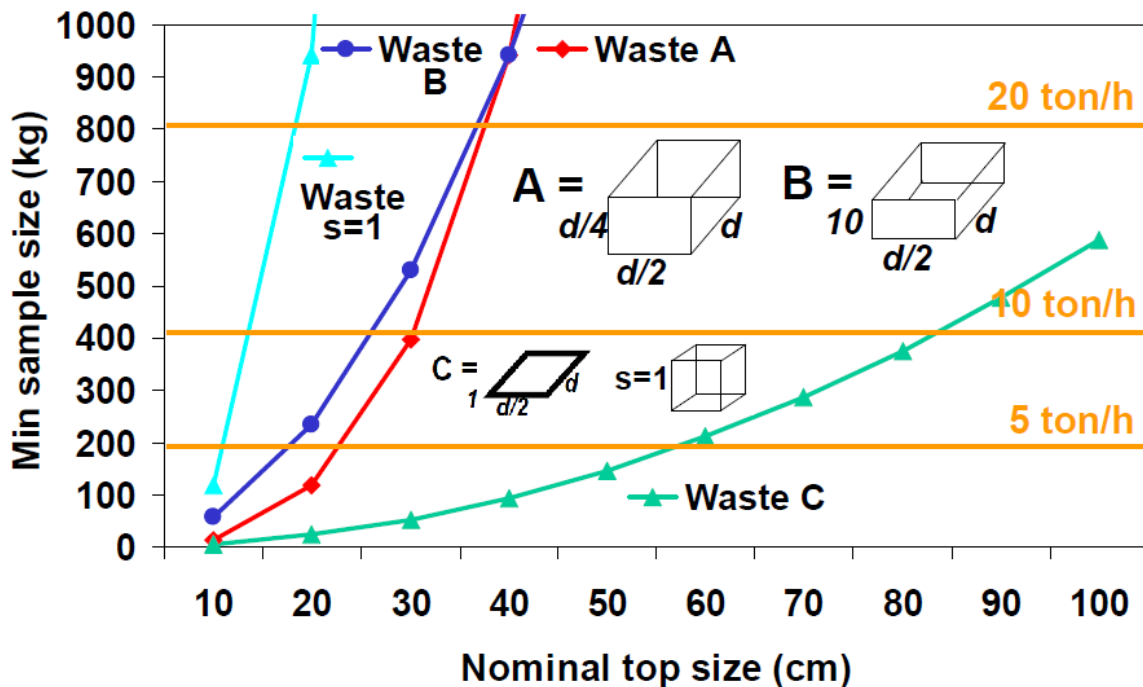

**Figure 5 The relation between minimum gross sample size and particle size or plant capacity. (Adapted from<sup>14</sup>)**

<sup>14</sup> Sampling and preparation of waste fuels. Evelina Wikström et al. SP. World Bioenergy 2006 Conference and Exhibition on Biomass for Energy Jönköping, Sweden, 30 May – 1 June, 2006. IEA Bioenergy Task 32 organised workshop: Fuel flexibility in biomass combustion. The key to low bio-energy costs?

As can be seen, different shapes generate different minimum samples, but for larger installations, the capacity will determine the sample size per lot. In the case that the SRF material contains large particles, the gross sample size is also quite significant, several hundreds of kgs, meaning that the 24 individual samples are of the order of tens of kgs. CEN/TC 343 has also elaborated a number of recommendations, specifications and standards relevant to the use and the analysis of SRF, see Appendix 1, Table A1.2.

#### **2.2.4. ISO/TC 300**

The work of CEN TC 343 has also led to the initiation of the development of a similar international standard with ISO TC 300, see Appendix 1, Table A1.3.

### **3. Waste quantities and disposal costs**

#### **3.1. WASTE SITUATION IN THE EU**

The EU has just over 500 million inhabitants (unevenly) spread over 4 million km<sup>2</sup>. The total amount of waste generated in 2014, was some 2 500 million tonnes<sup>15</sup>, including major mineral wastes. Most of this was of mineral origin, and was landfilled, recycled or used for backfilling. However, when excluding major mineral wastes some 900 million tonnes remained as waste water, construction and demolition wastes, manufacturing wastes and MSW, etc. Of all this waste, only a fraction is combustible. In total, some 138 million tonnes were incinerated, of which 102 million tonnes were incinerated with energy recovery. This includes sludges and combustible wastes, including MSW, used in waste to energy plants, cement kilns and as co-firing fuels.

The MSW generation per capita in the EU and some other European (EEA) countries is shown in Figure 6. The EU average is below 470 kg MSW per capita and year after peaking above 500 kg per capita and year in 2008, just before the financial crisis. The MSW generation is however not even across the Union. The countries in the northwest tend to be at the EU average or above it, and with a fairly stable or decreasing waste generation. Countries in eastern and southern Europe tend to be below average but also, due to the living conditions gradually approaching the situation in the northwest, tend to increase the waste generated per capita over time.

In Figure 7, the development of the MSW treatment in the EU is shown. The MSW generated peaked at 250 million tonnes in 2005 and has now been reduced to around 240 million tonnes. A decade ago, some 50 % of the wastes were disposed of by landfilling, incineration for volume reduction only (without heat recovery or unaccounted for in the statistics). In 2014, only 30 % of the MSW was sent to disposal or was unaccounted for. The overall recycling rate is 28 %, 16 % of the MSW is composted or digested while 24 % is incinerated with energy recovery.

Nevertheless, despite this general development away from disposal, the variation among the EU countries is still large, Figure 8. Again, in general terms the northern and western EU countries have a very low or low fraction of their MSW going into disposals by combining a high rate of recycling, composting and incineration with energy recovery. The eastern and southern EU countries are still using landfilling as their main disposal method for MSW, and also have significantly lower rates of recycling and other treatment methods.

---

<sup>15</sup>Eurostat data

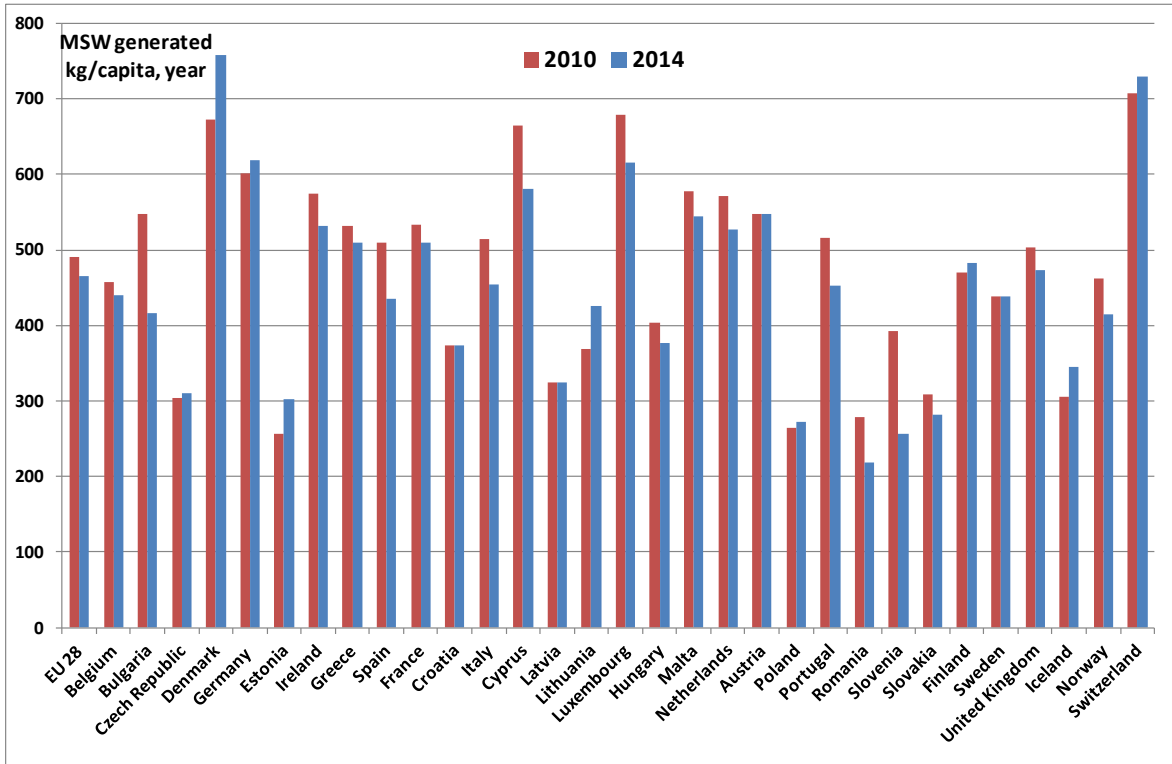

Figure 6 Per capita MSW generation in EU and EEA countries in 2010 and 2014. Data from<sup>16</sup>.

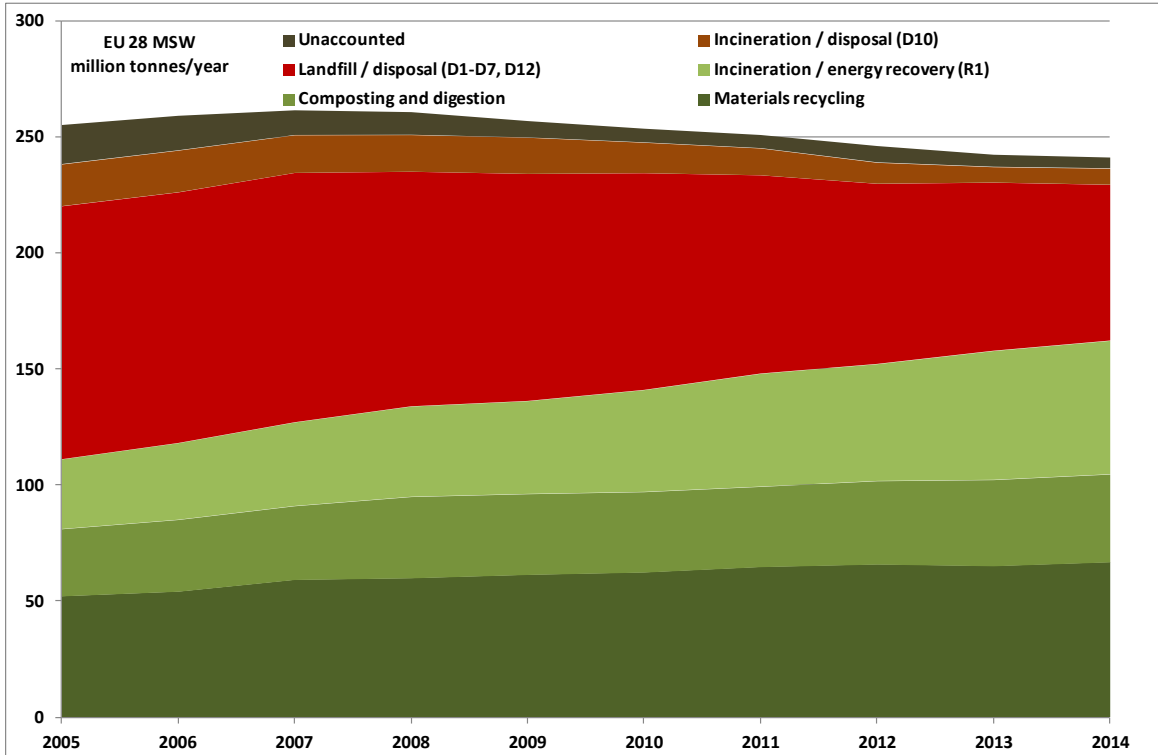
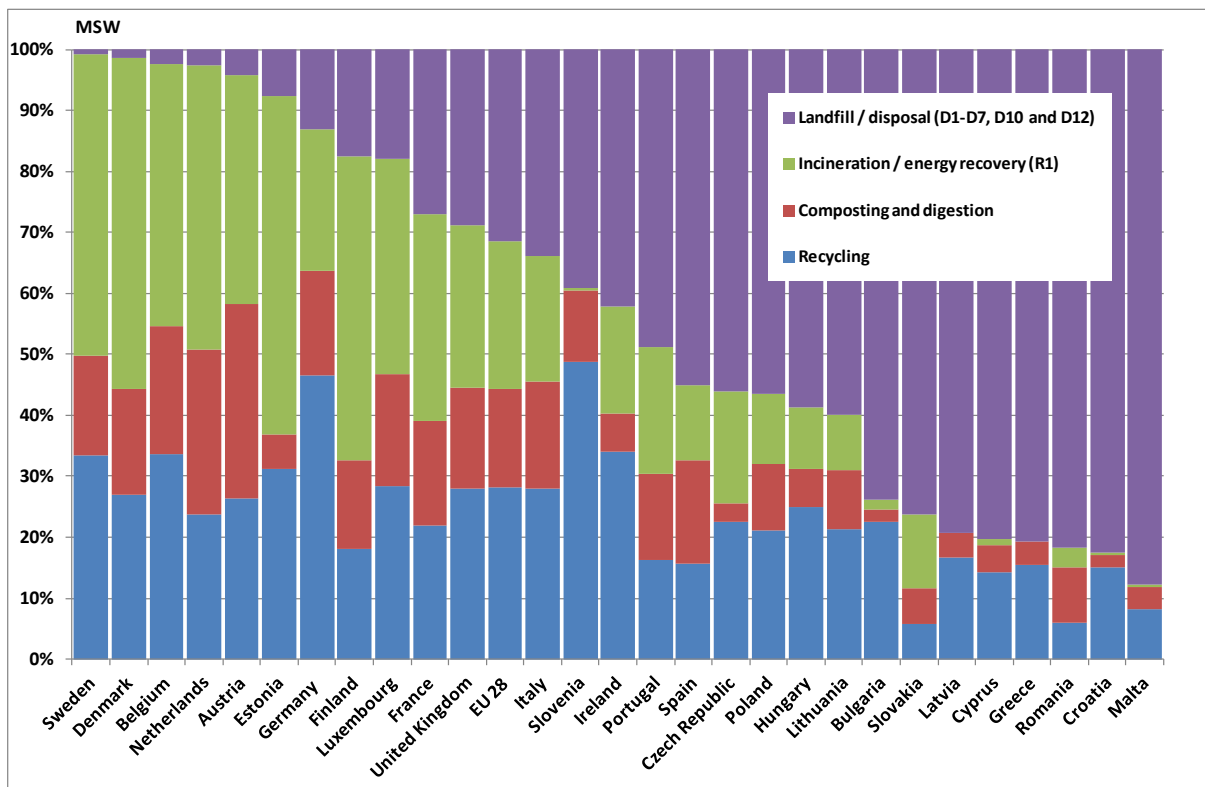

Figure 7 The MSW treatment and disposal in EU28<sup>16</sup>.

<sup>16</sup> Eurostat data



**Figure 8 The relative MSW treatment and disposal methods in the EU<sup>16</sup>**

The uneven share of thermal treatment of MSW shown in Figure 8 is also reflected in the number of incinerators in the different member states, and their treatment capacity, Figure 9. There were 435 incinerators in the EU in 2014, plus 30 and 17 in Switzerland and Norway, respectively. Although some of these, in particular in the UK, are referred to as “gasifiers”, in reality only a handful installations have post-treatment of the gas produced and the characteristics that are different from conventional incinerators.

In total 83 million tonnes were incinerated in these units within the EU and another 5 tonnes in the two non-EU states included in the graph. This is a higher number than the 58 million tonnes of MSW incinerated in the overall EU statistics above (24 % of 240 million tonnes), i.e. also other waste streams that have not been included in the MSW category of the EU statistics have been used as a fuel, e.g. some construction and demolition and manufacturing wastes, as well as shredder residues. France and Germany have by far the highest number of incinerators and also the highest thermal treatment capacity in weight terms. It is also evident that many countries have no or only 1 or 2 incineration plants.

The average capacity usage per plant was in the range of 0.10-0.25 million tonnes per year, but with a significant deviation for the Netherlands, where the average capacity was 0.60 million tonnes per plant. Overall, the electricity generation is approximately 30 TWh or 360 kWh/ton, but also 80 TWh of heat is recovered (in addition, around 50 TWh of process heat is used in cement and lime industry).



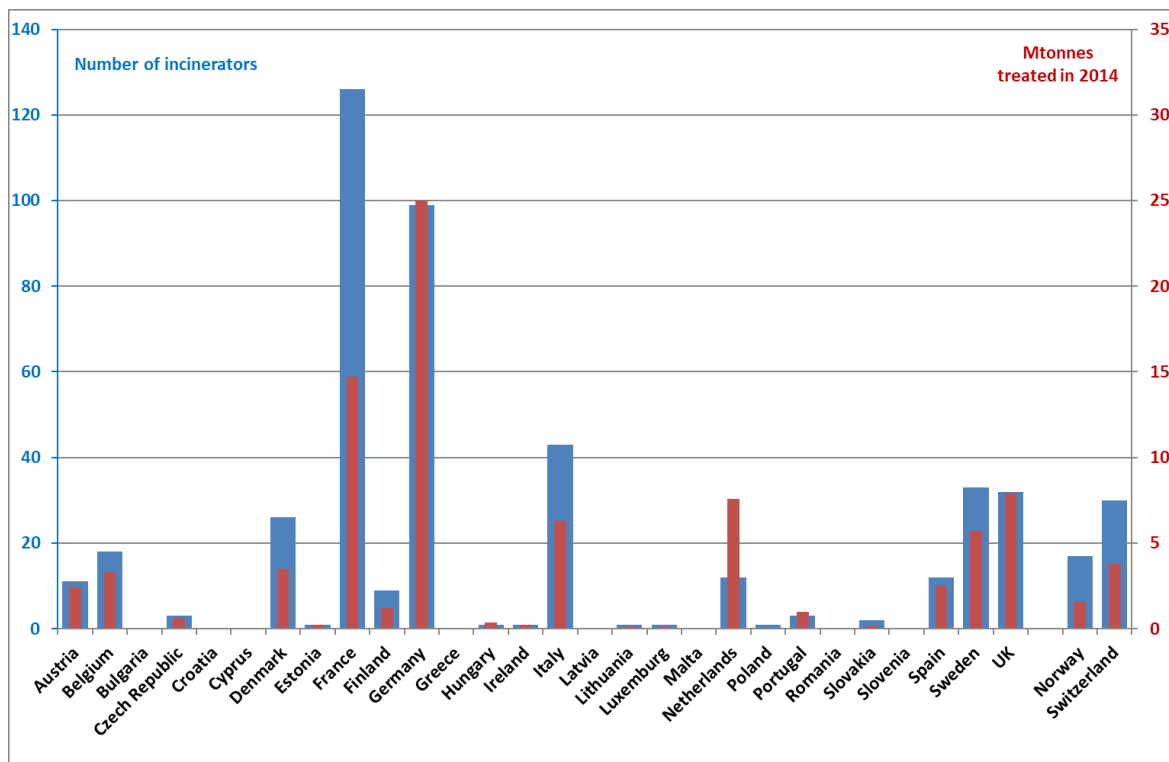

**Figure 9 Number of R1 waste incineration plants in the EU, Norway and Switzerland and the treatment capacity in each country in 2014<sup>17</sup>.**

In most countries in the EU, the cost of treatment by incineration does not reflect the cost of landfilling as an alternative. Austria, Belgium, Denmark, Finland, Luxemburg, Netherlands, Sweden but also Norway and Switzerland have banned more or less all organic waste or MSW from landfilling. Bans for landfilling of untreated MSW are in place in Estonia, France, Germany, Hungary, Italy, Latvia, Poland, Romania, Slovakia, Slovenia and the UK. Bulgaria, Czechia (until 2023), Cyprus, Estonia, Greece, Ireland, Lithuania, Malta, Portugal and Spain have not yet introduced some form of ban for landfilling in 2017<sup>18</sup>. In addition, most countries, with the exception of Cyprus, Germany, Hungary, and Malta also have a landfill tax ranging from 10 to 90 €/tonne, irrespective if a ban is in place or not.

Instead, gate fees for incineration plants typically reflect the balance between the energy sales revenues available and the variable and fixed operating costs of the plant. Furthermore, the collection and disposal of household wastes is a responsibility of the local communities in most countries, the citizen pays for the collection and treatment cost, and communities can then perform this service or sub-contract it to licensed private contractors. However, in some countries commercial and industrial waste collection is the responsibility of the generator of the waste. The treatment of these types of wastes is based on market pricing for both community and licensed private contractors, and there is also a market for secondary fuels for use in e.g. cement kilns or as co-firing fuel in coal-fired power plants. In addition, there is also trade in treated wastes suitable for incineration between different countries with shortage or excess incineration capacity.

This means that the situation is a combination of local monopolies and open market situation, and price fluctuations can occur relating to capacity available, etc. Below are some examples of the gate

<sup>17</sup> <http://www.cewep.eu/landfill-taxes-and-bans/>

<sup>18</sup> For detailed information see [http://www.cewep.eu/media/www.cewep.eu/org/med\\_557/1529\\_2016-10-10\\_cekewep\\_-landfill\\_inctaxesbans.pdf](http://www.cewep.eu/media/www.cewep.eu/org/med_557/1529_2016-10-10_cekewep_-landfill_inctaxesbans.pdf)

fee levels seen for RDF, for SRF slightly lower gate fees are typically used due to the better quality. Most data below are from the period 2014-2016, since less public data is available for more recent periods.

In the UK, where landfilling is still allowed, a landfill tax of 86 £/tonne 2017 (just over 90 €/tonne) supplemented with the actual landfill cost, median 19, range 8-62 £/tonne (22€ range 9- 70 €/tonne) is a strong deterrent for landfilling materials that can be recycled or treated in other ways. There is also an export of RDF, amounting to somewhere in the range of 2.5 to 3.3 million tonnes in 2015 or about 10 % of the total RDF generated, going to predominantly the Netherlands, Germany and Sweden. The reported gate fees for WtE plants in the UK in 2017 were 56 £/tonnes range 26-90 (64, range 29-100 €/tonne) and 95 range 50-144 £/tonnes (105, range 75-160 €/tonne) for plants licensed and with contracts before and after the year 2000, respectively<sup>19</sup>. The difference in the age reflects the more favourable situation some decades back regarding power prices and the value of long-term contracts entered at the time, whereas the more recent plants reflect the current market situation. The spread in the gate fee reflects a large number of factors relating to the individual plant and its ownership and financing, the local situation in terms of capacity shortage or excess as well as opportunities for export.

In Germany, there has been a large build-up of incineration capacity in the first decade of this century. Combined with less combustible wastes generated and a trend of higher calorific value of the wastes, this caused a significant excess capacity, in particular in the East and Northeast of the country<sup>20</sup>. The excess capacity for waste treatment facilities in wide parts of Germany has led to that gate fees for MSW mostly is below 60 €/tonne delivered to the plant. Tendering in the eastern federal states show prices between 30 and 40 €/tonne net, while long-term contracts concluded with a start year in 2005 or self-cost pricing are often in a range between 70 and 140 €/tonne net<sup>21</sup>. Another source<sup>22</sup> cites gate fees in the east at 40 €/tonne for MSW and spot gate fees for commercial waste in the range of 30-50 €/tonne, while in the rest of Germany prices are 20-30 % higher. This has caused a flow of commercial waste from the south to the east.

A similar situation is also at hand in the Netherlands, where an incineration tax of 13 €/tonne has led to that gate fees are above 50 €/tonne<sup>23</sup>. More generous gate fees are offered for imports from the UK, which have resulted in a spill-over of wastes from the Netherlands to Germany. RDF from Great Britain is however only of a medium calorific value and is therefore typically used without further treatment in MSW incinerators with gate fees in the range of between 50 and 65 €/tonne<sup>23</sup>. This causes worries for German RDF producers. In the past high-quality, high calorific value RDF was providing a revenue of 20 €/tonne for some MBT operators, while other qualities could be disposed of at a gate fee of 30 €/tonne to RDF-burning facilities. However, in later years the RDF gate fee has risen to 40-60 €/tonne, this having negative impact on the economics of waste recycling and treatment facilities.

However, the most recent published information found regarding Germany, is that the excess capacity in combustion facilities has been reduced, and to close to 100 percent capacity usage was logged in 2016. This change results from both from an increase in the wastes generated and from

<sup>19</sup> WRAP (2017) Gate fees summary report 2017. [www.wrap.org.uk](http://www.wrap.org.uk)

<sup>20</sup> Marktumfeld für die Abfallverbrennung in Deutschland. Hansjörg Roll und Philipp Chartschenko. CD Energie aus Abfall, Band 11 und Planung und Umweltrecht, Band 8. TK Verlag Karl Thomé-Kozmiensky. 2014

<sup>21</sup> Restabfallentsorgung in Deutschland – Gibt es eine Zukunft für die MBA? Mathias Morgernstern. 16. Dialog Abfallwirtschaft Mecklenburg-Vorpommern. Rostock, 3. April 2014

<sup>22</sup> Bedarf an Restabfallbehandlungskapazitäten in Deutschland. Peter Kurth, Sandra Giern, Annette Ochs. Strategie Planung Umweltrecht, Band 9. TK Verlag Karl Thomé-Kozmiensky. 2015

<sup>23</sup> German plants under pressure from UK exports of RDF - [letsrecycle.com](http://letsrecycle.com). 3 June 2015

the impact of the imports, causing increases in the gate fees demanded on the spot market<sup>24</sup>.

In Sweden the gate fee for MSW was 35-45 €/tonne in 2014, while cost of RDF was in the range of 0-20 €/tonne, this price range reflecting the internal cost of the treatment and recovery operation of the MSW or other primary waste<sup>25</sup>. Unlike many other countries, the primary product produced is heat for district heating, such that very high overall efficiency from waste to power and heat is achieved, which has an impact on the economics. This also causes the Swedish facilities to offer lower gate fees than in other European countries, and there is an excess capacity of thermal treatment, in addition to the 5.2 million tonnes of indigenously wastes generated and treated in 2017, amounting to the magnitude of 1.4 million tonnes based on imports of waste from Norway, UK, Ireland and elsewhere<sup>26</sup>. The excess capacity for 2022 is expected to be of the same magnitude, depending if elderly plants are replaced or not. The gate fee was in the past<sup>27</sup> below 30 €/tonne but in 2016 it rose<sup>28</sup> to 43 €/tonne, following trends elsewhere. However, this is partially off-set by the higher transport costs associated with exports to Sweden relative to the Netherlands or Germany.

### **3.2. WASTE AND WASTE TREATMENT IN JAPAN**

Japan is a populous nation with 120 million inhabitants, and with a land area of 0.36 million km<sup>2</sup> (similar to the UK) but where the topography of the country results in that only some 10 % of the land area is suitable as residential area. The development in the waste generated in Japan is shown in Figure 10. From 1950 and up to the turn of the century, the generation of MSW has risen almost one order of magnitude and also industrial waste have had a similar trend. However, from the turn of the century, both MSW and industrial waste generation have started to decrease.

There have been rather strong policy measures, see Section 4.4, to reduce both the rate of waste generation and the rate of landfilling in Japan, as the limited available land makes it difficult to find suitable areas for landfilling, and these are associated with high disposal costs. Therefore, incineration has for a long time been an important part of waste treatment. Figure 11 shows that already in 1980, incineration was the dominant treatment method for MSW, followed by landfilling, and with little recycling. Of the MSW landfilled in 1990, some 60 % was landfilled directly and the remainder was residues from recycling and treatment, e.g. incinerator ashes. Since then, landfilling has actively been decreased despite an increased generation of MSW, while incineration has increased, and direct and post-treatment recycling has been become a significant activity.

In 2014, 44.4 million tonnes of MSW were generated in Japan<sup>29</sup>, equivalent of 350 kg per capita and year. Only approximately 4.3 million tonnes were landfilled, and of this quantity only some 10 % constitutes direct disposal in landfills. At the same time, approximately 1/3 of the landfill capacity available at the turn of the century has since been phased out. Nevertheless, the reduction in direct and post-treatment has been more dominant such that the remaining landfill capacity for MSW has risen from 13 to 20 years in this period<sup>30</sup>. The recycling was 9.1 million tonnes, i.e. some 34.8 million tonnes underwent some form of treatment, and then predominantly incineration.

There were as many as 1 162 MSW incinerators in operation in 2014. The average capacity of these was 158 tonnes/d, or 0.05 million tonnes per year, i.e. considerably smaller than in the EU and US.

<sup>24</sup> Capacity and legal steering of Waste-to-Energy in Germany. Carsten Spohn. 9th Beacon Conference Waste-to-Energy, State of the Art and Latest News November 18–19 2015 in Malmö, Sweden

<sup>25</sup> El från nya anläggningar 2014. Elforsk rapport 2014:40

<sup>26</sup> Kapacitetsutredning 2017. Tillgång och efterfrågan på avfallsbehandling till år 2022. Avfall Sverige, Rapport F2017:16

<sup>27</sup> <http://www.tolvik.com/sweden-in-the-hunt-for-rdf/>

<sup>28</sup> <http://www.tolvik.com/profus-2016-branslemarknadsdagen-fuel-market-day-sweden/>

<sup>29</sup> <https://www.env.go.jp/en/headline/2218.html>

<sup>30</sup> Municipal Waste Policy in Japan. Shusaku Yamaya, Toyo University, Japan. ACT Government, 19 March 2015

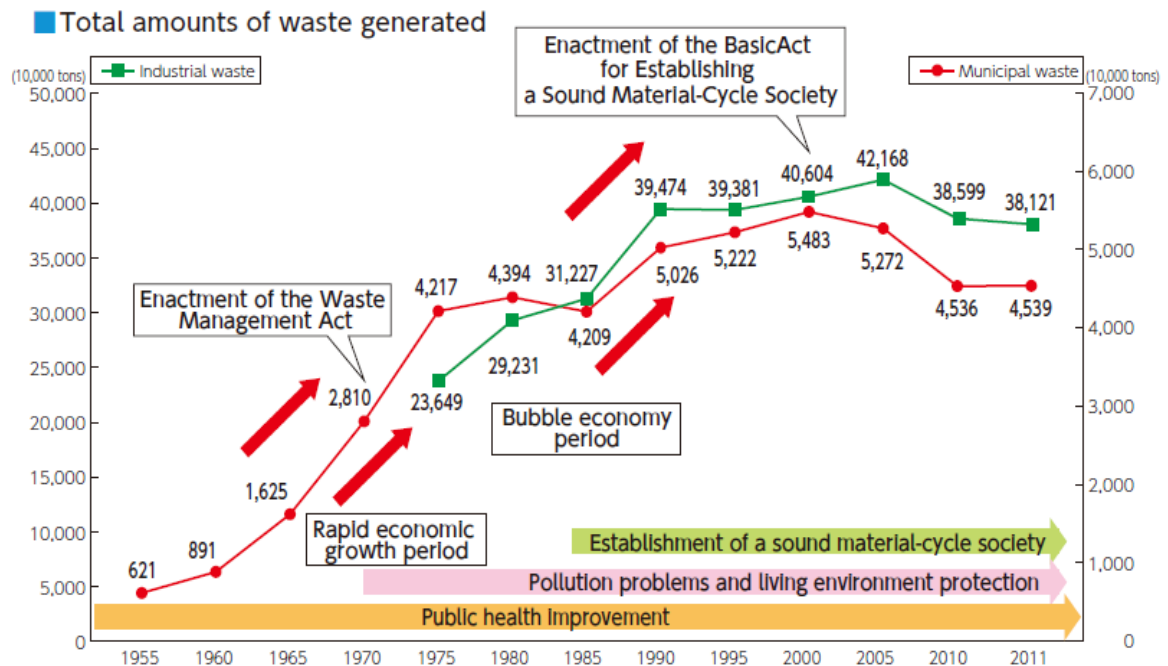

**Figure 10 Waste generation statistics in Japan<sup>31</sup> (note the different scales for industrial waste and MSW, respectively).**

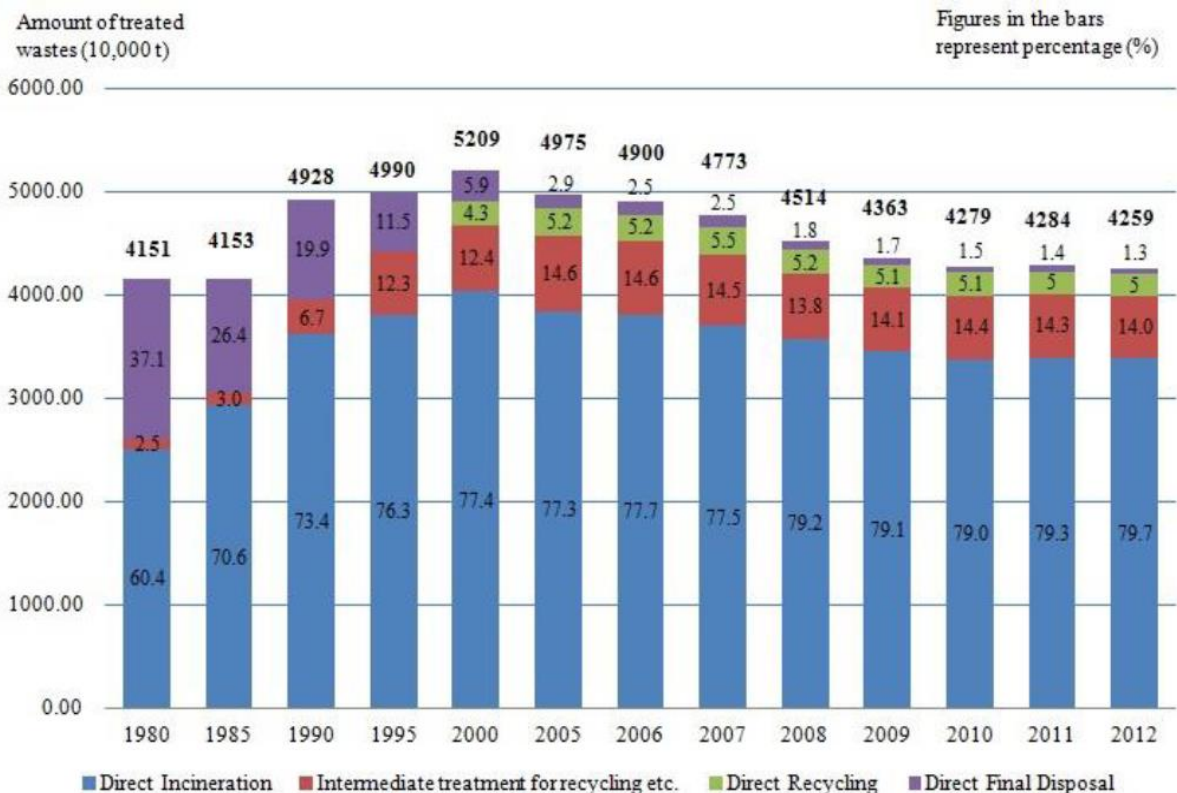

**Figure 11 MSW waste treatment in Japan<sup>32</sup>**

<sup>31</sup> History and Current State of Waste Management in Japan. Ministry of Environment, Japan, February 2014

<sup>32</sup> Waste Management and Recycling in Japan. Opportunities for EU SMEs. Christine Yolin. EU-Japan Centre for Industrial Cooperation. Tokyo, September 2015

In 2014, 250 incinerators were below 30 tonnes/day, some 600 were below 100 tonnes/day, and only 200 were above 300 tonnes/day<sup>33</sup>. Comparing this with the waste 35 million tonnes undergoing treatment, the installed capacity, if fully used, would correspond to 60 million tonnes, i.e. there is a considerable overcapacity. Of the total numbers of incineration plants, 338 plants had power generation with an installed capacity of 1.9 GW, while 764 plants used the heat generated (some of which presumably CHP installations). In 2013, 6.2 TWh<sup>34</sup> was generated from MSW, an average of only around 200 kWh/tonne waste, a relatively low utilization factor. In 2014 the generation had risen to almost 8 TWh<sup>35</sup>.

In terms of gasification installations, where Japan is the leading nation in the world, there were 109 installations in Japan in 2011 (50 shaft furnaces, 39 fluid beds and 12 rotary kilns for gasification ash melting as well as 7 units for gas reforming), while another 3 units were added in 2012<sup>36</sup>.

At the turn of the century, when gasification and ash melting procedures were introduced on the market as a direct consequence of the strong anti-dioxin measures promoting landfilling of vitrified ash, the market share was high until 2005, when the regulations no longer made it a requirement. The development of the market positions for different technologies on the Japanese market up to 2012 is shown in Figure 12.

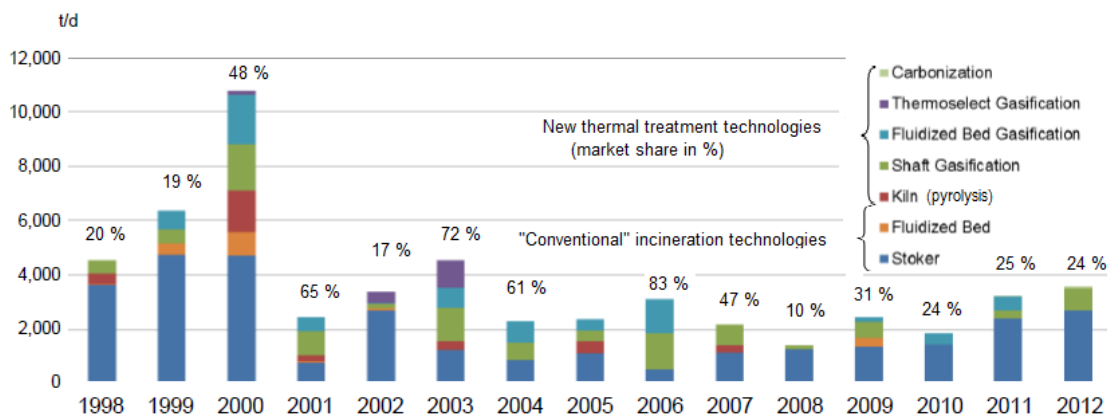

Average market share, new thermal treatment technologies (NTTT)

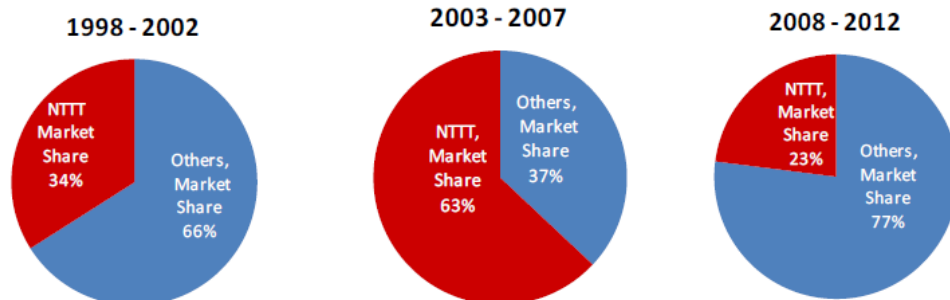

**Figure 12 The development on the Japanese waste thermal treatment market. (adapted from<sup>37</sup>)**

<sup>33</sup> Governmental action of waste management and briefing of waste treatments in Japan. Yukihiisa SAKATA. JASE-world. Waste to Energy WG. November 2014

<sup>34</sup> IEA Statistics Report, Japan

<sup>35</sup> Annual Report on Environmental Statistics 2017. Ministry of Environment, Japan, 2017.

<sup>36</sup> Latest Results of Bottom Ash Handling in Japan. Nobuhiro Tanigaki. 16/4/2015 Japan Environmental Facilities Manufacturers Association (JEFMA) /NIPPON STEEL & SUMIKIN ENGINEERING CO., LTD.

<sup>37</sup> Sachstand zu den alternativen Verfahren für die thermische Entsorgung von Abfällen – Schlussbericht. P. Quicker, F. Neuerburg, Y Noël, A. Huras, R. G. Eyssen, H. Seifert, J Vehlou, K Thomé-Kozmiensky. 1. September 2014. Bundesministerium für Umwelt, Naturschutz, Bau und Reaktorsicherheit. Vorhaben Z 6 -30 345/18 Projektnummer 29217.

There are also other ash melting technologies, electric melting and using the energy in the fuel to have direct melting, of which there were 56 and 52 installations, respectively, in 2012.

The new technologies introduced around 2000 had a strong share of the (relatively small) market up to 2008, and then it has lost out for incinerators. The impression from press releases after 2012 and resulting from the regulations promoting higher efficiency to power and heat (where ash melting is an internal heat load of significance reducing the net output) in combination with the Feed-In Tariff (FiT) system, is that conventional technologies are now even more dominating, but no later source of data to confirm this have been found. Still, in some areas landfilling is still costly and capacity scarce, such that the gasification-ash melting technologies still can hold some ground on the market.

There are fewer figures available for industrial wastes. The overall generation of industrial wastes and the treatment routes are shown in Figure 13.

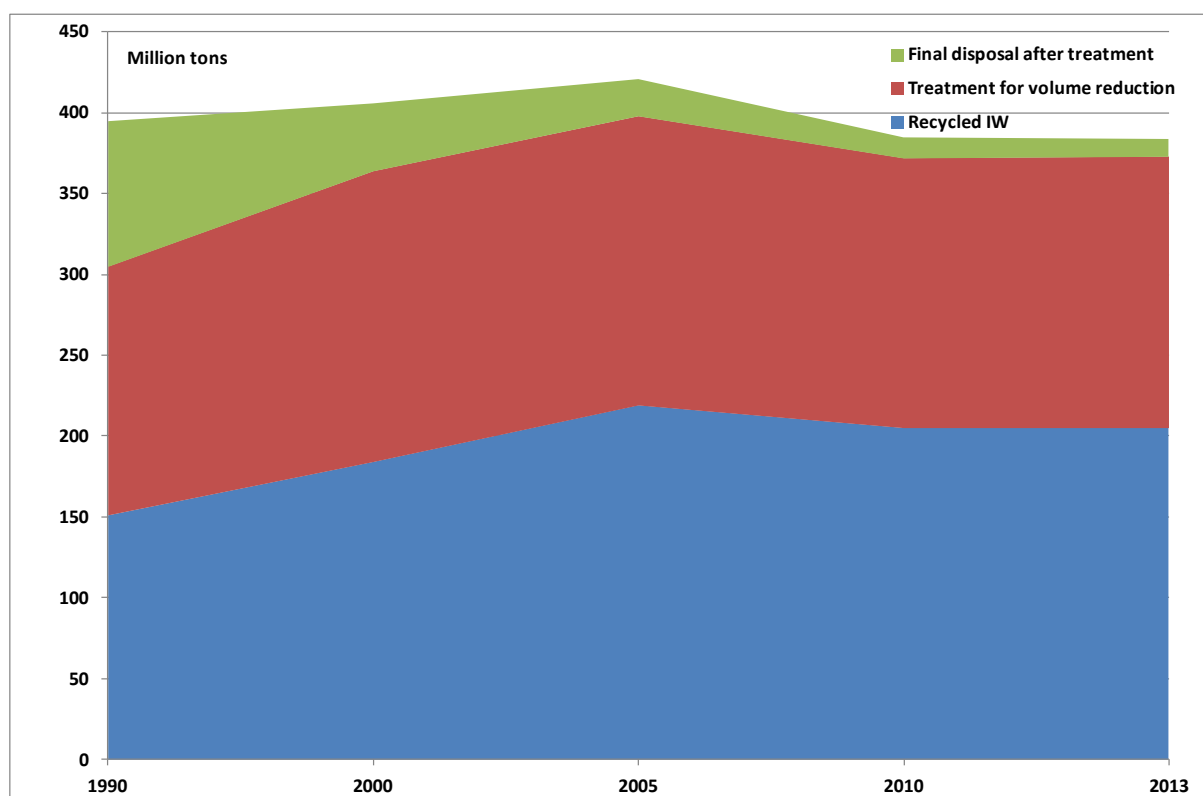

**Figure 13 Industrial waste generation and treatment in Japan** <sup>38</sup>

The amount of waste generated peaked at 420 million tonnes around the turn of the century. Treatment in this case includes incineration, drying and milling/compaction. The final disposal after treatment also includes a significant fraction of direct disposal without treatment, which in 2014 amounted to 6 million tonnes, i.e. more than half of the disposal quantity.

The number of industrial incinerators is difficult to find in the statistics and also include e.g. black liquor boilers as this is seen as waste<sup>39</sup>, and often involves autogeneration within industries. The installed capacity in 2012 was estimated to some 1.2 GW generating 2.4 TWh<sup>34</sup>.

<sup>38</sup> Statistical Handbook of Japan 2016. Statistics Bureau. Ministry of Internal Affairs and Communications Japan, 2016

<sup>39</sup> Energy Technology Roadmaps of Japan: Future Energy Systems Based on Feasible Technologies Beyond 2030. Yukitaka Kato, Michihisa Koyama, Yasuhiro Fukushima, Takao Nakagaki. Springer, 30 maj 2016

The situation regarding disposal sites for industrial wastes is worse than for MSW, on an average in 2012, there were only 14 years left of remaining capacity, and in e.g. the Tokyo area only 5 years left<sup>39</sup>. In total, the disposal to landfills already meets the target of 17 million tons set for 2020<sup>40</sup>.

The situation with strong policy measures to reduce the landfill volume and the general shortage of landfill volume also means that, in general, the cost for landfilling wastes is very high in Japan, and landfilling of wastes that can be treated by other methods is discouraged. This also means that the accepted cost of treatment is very high compared to the EU and USA, reported to be of the order of 300-400 €/ton waste<sup>37</sup>.

### 3.3. WASTE SITUATION IN THE USA

USA has a population over 320 million people, but also a relatively large land area of 9 million km<sup>2</sup>. In the United States, 234 million (metric tons) tonnes of MSW were generated in 2014, up by 4 million tonnes from 2013. This translates to over 700 kg per capita and year, Figure 14, which is far higher than the Japan at 350 kg and the EU28 average of 470 kg. The per capita generation of MSW rose very rapidly from 1960 to 2000, to level off for some years before a decline in 2009. If this decline relates to changes in the waste generation or is an effect of the financial crisis remains to be seen.

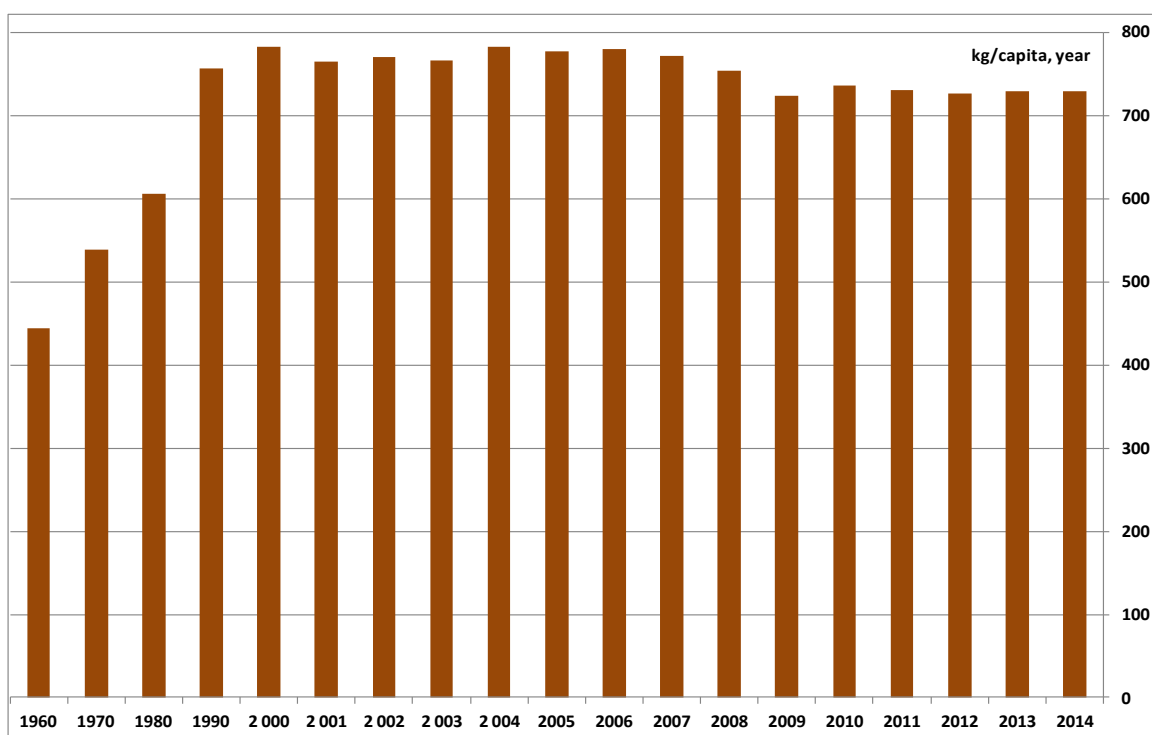

**Figure 14 Per capita generation of MSW in the USA (based on data from <sup>41</sup>)**

Figure 15 shows the trends in the treatment of MSW. About 60 million tonnes of MSW (26 %) were recycled, 21 million tonnes (9 %) were composted and 30 million tonnes (13 %) were incinerated in 2014. The remainder, 114 million tonnes or 52 %, went to landfills. Historically, landfills have had an even more dominating role. But there is a wide difference between the individual states in both the recycling rate, and in the use of landfills and incineration, Figure 16.

<sup>40</sup> Comprehensive 3R Policy Framework towards a Sound Material Cycle Society in Japan. Masahito Fukami, Minister's Secretariat. Ministry of the Environment, Japan

<sup>41</sup> <https://www.epa.gov/smm/studies-summary-tables-and-data-related-advancing-sustainable-materials-management-report>

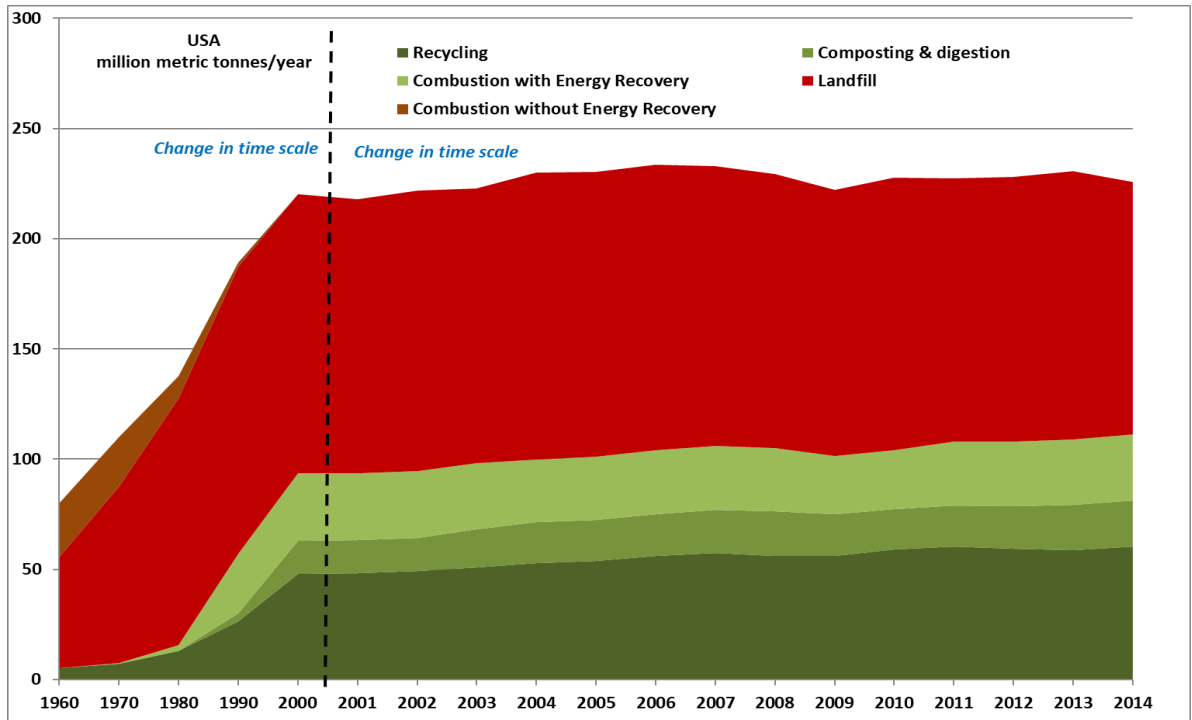

Figure 15 Development of MSW generation and treatment in the USA (based on data from<sup>41</sup>)

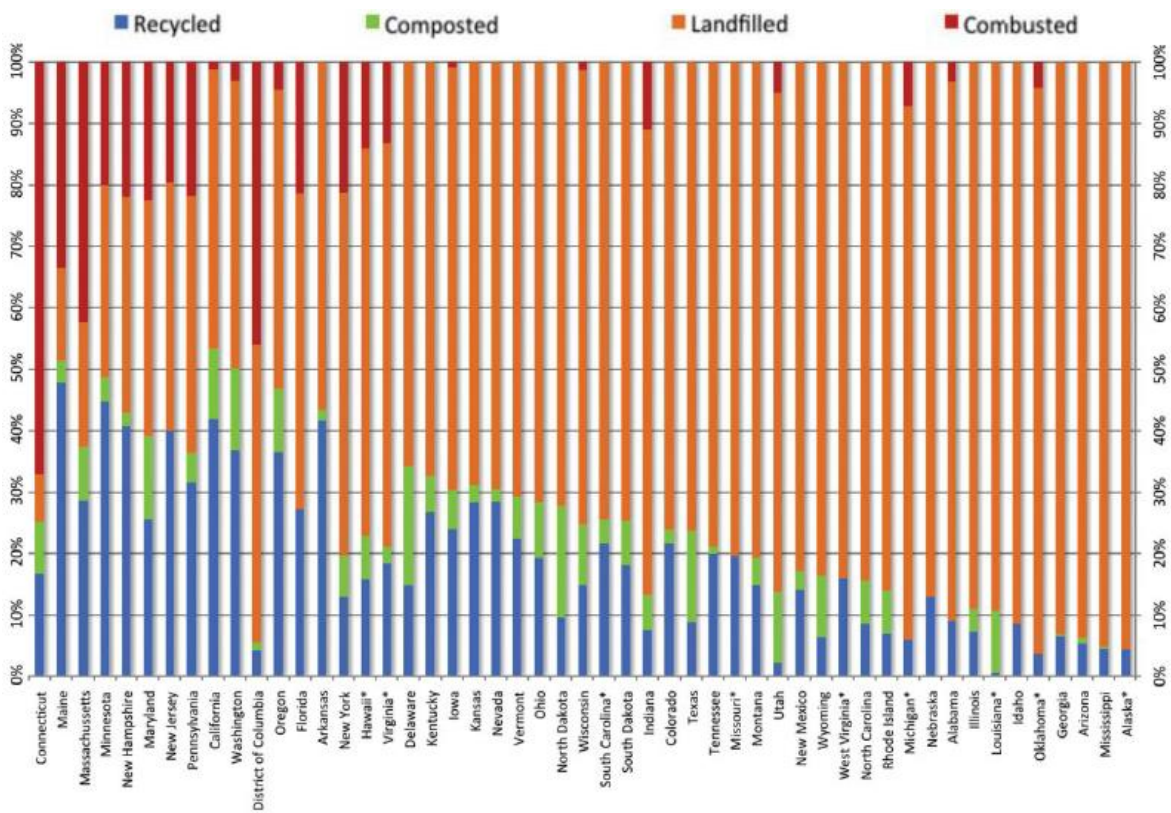
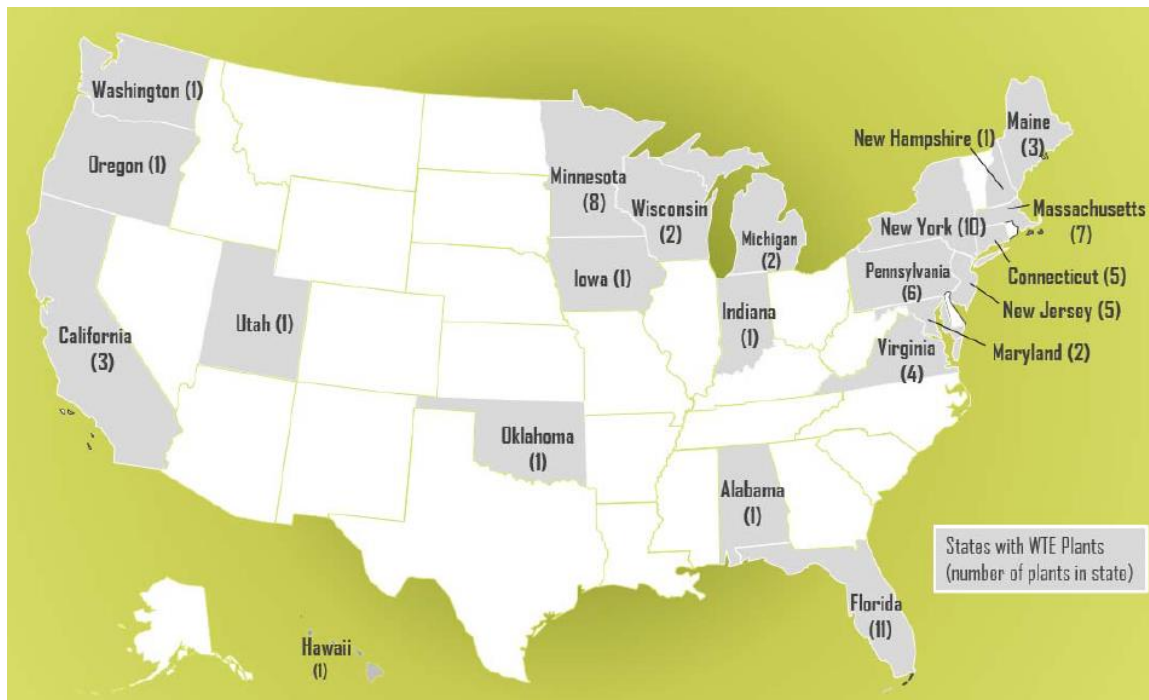

Figure 16 The management of waste methods in the US states in 2011<sup>42</sup>

<sup>42</sup> Survey of MSW Generation and Disposition in the US. N. J. Themelis and D Shin. MSW management Nov-Dec 2015.





**Figure 17 States with one or more WtE plant<sup>43</sup>.**

In 2014, there was almost 800 Material Recovery Facilities (MRF) with a capacity of close to 50 million tonnes and 1 900 landfills<sup>44</sup>. There were 77 Waste-to-Energy incinerator facilities in operation, Figure 17. Half of these are owned by private and half owned by public entities, with in total close to 200 incineration units. None of these units use gasification. The most common type burned MSW directly, only 13 units used RDF. The most common energy recovery was by electricity alone, 59 units, followed by CHP, 15 units, and steam only in 3 units. The installed electric capacity was 2.5 GW. The units used 26 million tonnes in 2014 to produce 14 TWh of electricity, i.e. an average of 538 kWh/tonne. This also means that the average incinerator site annual capacity was 0.34 million tonnes per year.

The average cost of landfilling in the USA is shown in Figure 18 (note that the graph is based on short tons, 0.91 ton/tonne (metric ton)). The cost is considerably lower than in most countries in the EU or in Japan.

A survey<sup>45</sup> made in 2013, showing high, low and average gate fee values for all states indicate that overall the average gate fee in the different states is in line with the values in Figure 18, whereas there is a considerable spread in the state averages, from 25 \$US/ton in Montana and Nevada to over 90 \$US/ton in Maine, and over 80 \$US/ton in Vermont and Washington. There is also a considerable spread between the highest and lowest tipping fees within the individual states, in some cases the deviation from the average is as high as 50 % of this figure.

<sup>43</sup> 2016 Directory of waste-to-energy facilities. Energy recovery council, USA, 2016

<sup>44</sup> Advancing Sustainable Materials Management: 2014 Tables and Figures. EPA, November 2016.

<sup>45</sup> <http://www.cleanenergyprojects.com/Landfill-Tipping-Fees-in-USA-2013.html>

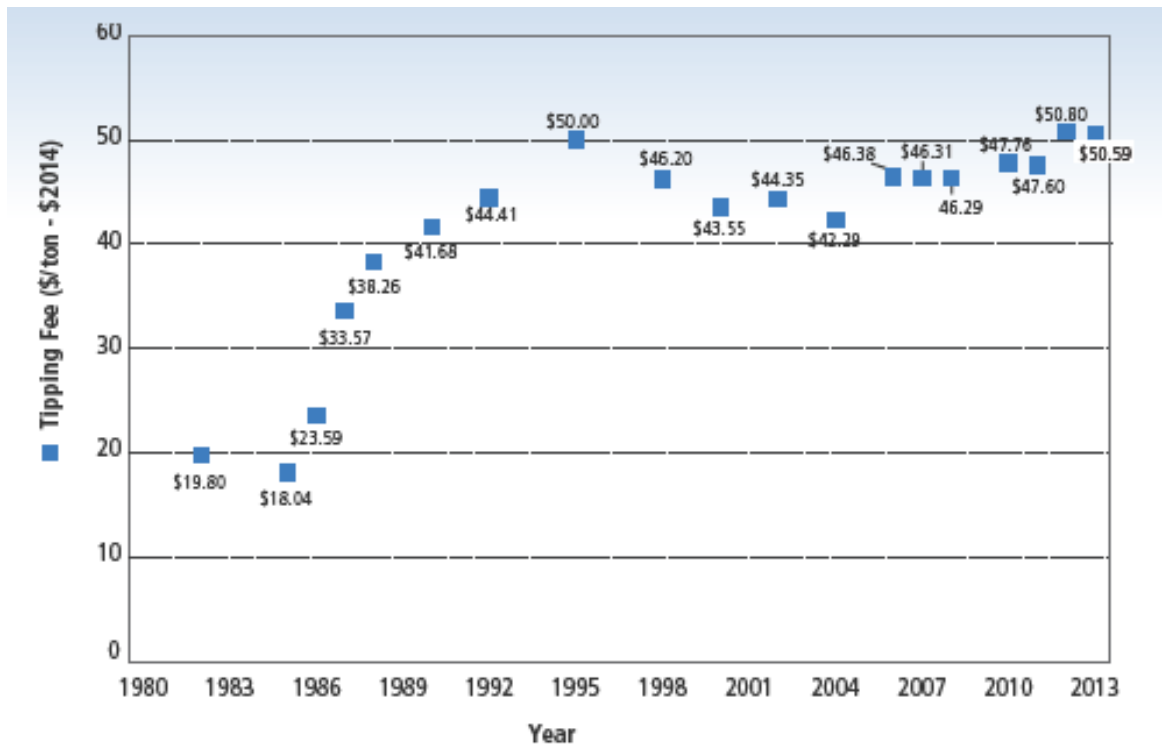

**Figure 18** The average landfill tipping fee in USA, nominal 2014 \$US per short ton<sup>44</sup>.

### 3.4. OTHER ASIAN STATES

In China, the estimate is that some 225 million ton of MSW is generated, but statistics are uncertain<sup>46</sup>. In 2010, 16 % of MSW was combusted while more than 80 % went into landfills. The waste quality is low, even if some separation of glass and incombustibles takes place. The energy content is in the range of 5-7 MJ/kg, making even incineration difficult and low in efficiency<sup>47</sup>.

However, at the same time, China is the fastest growing market for thermal waste treatment plants. Since 2008, 78 new waste incineration plants have started operation. A Chinese State Council decree of 2010 named 600 other cities where waste to energy should be installed at a rate of 40 million tons per year capacity each year. The domestic contractors have a strong position, as their cost levels is only one third of e.g. European cost level<sup>48</sup>, and these are also expanding their market abroad. However, alternative thermal processes have not yet come into the wider discussion in China<sup>37</sup>, but certain initiatives have led to the use of waste gasification in more than twenty cements plants in the last decade.

South Korea is also active in the field of thermal waste treatment. Between 2008 and 2012 an overall gasification capacity of 325 000 tons/year was installed in seven installations built, of which four used Japanese technologies (Ebara 2, Nippon Steel 2). In other states, e.g. India and Vietnam, WtE projects are being installed and planned, however wastes are largely unsorted and have a low calorific value while landfill costs are still very low, conditions that are not favouring gasification technologies.

<sup>46</sup> Status and Perspectives of Waste Incineration in China. M. Nelles, T. Dorn, K. Wu, J. Cai. Proceedings of the International Conference on Solid Waste 2011- Moving Towards Sustainable Resource Management, Hong Kong SAR, P.R. China, 2 – 6 May 2011

<sup>47</sup> Status and Perspectives of Waste Incineration in China. M. Nelles, T. Dorn, K. Wu, J. Cai. International Conference on Solid Waste 2011- Moving Towards Sustainable Resource Management, Hong Kong SAR, P.R. China, 2 – 6 May 2011

<sup>48</sup> 150 €/ton, year vs. 450 €/ton, year in the EU.

## 4. Waste policies and regulatory considerations

### 4.1.1. OVERVIEW OF WASTE POLICIES (FROM DISPOSAL TO CIRCULAR ECONOMY)

Wastes can be defined as less desirable residues from production, use or post-use of desirable materials such as edible substances, materials, components and aggregates for use by individuals, households or businesses, in constructions or generated by industrial processes, including such materials no longer desired, possible or fit for use.

Wastes have obviously been generated from the dawn of human history, and the study of waste dumps in various forms are also from archaeological studies an important source of knowledge on pre-historic cultures and their socio-economics. Early settlements typically dumped waste in their immediate vicinity and once in a while resettled on the top of the debris. When such population centres grew and affluence, *disposal* of the wastes generated was required and such dumps became organized and eventually covered after use, i.e. primitive landfills. There is evidence for such activities in various parts of the world including in the Minoic culture, Egypt, biblical Middle East, China, Japan and South America<sup>49, 50, 51, 52</sup>. Eventually, such dumps also were burned, intentionally or accidentally. It has been alleged, but also disputed, that one such site was located at Sheol in the valley of Gehenna outside Jerusalem where fires were burning day and night, and in the Bible used as a contrast to heaven, i.e. connotations to a "hellish" site.

The first documented waste regulation was adopted in Athens in Greece 500 B.C, then a city of some 300 000 inhabitants. It prohibited dumping of waste into the streets; instead specialized workers ("scavengers", presumably slaves) removed wastes to an open dump located 1.5 km outside of the city. The same type of regulations was introduced in most major cities in the classic antique period. Also, under other settings this service has been viewed as shameful and impure, whereby slaves or certain defined groups were performing such services (dalit caste in India, hinin in Japan, non-muslims in the Arabic world). Still today, garbage collector is probably not a career choice approved by most parents, despite more appealing titles (recycler, environmental technician, etc.), although there is a wide consensus on the necessity of having the task performed diligently.

For the centuries to come, wastes were either dumped in the streets unless prohibited by local ordinances in combination with a more or less organized removal to be dumped at specific sites or into rivers, lakes or the sea, although associated with smell, water pollution and vermin that caused health problems and outbreak or epidemic diseases.

The industrial revolution had two effects regarding wastes; urbanization concentrated the generation of organic waste to the increased populations in towns and cities and also added new types of industrial and energy wastes. The waste quantities, and the population affected by it, rose simultaneously, and led to stronger regulation, starting in the cities of UK in the mid-19<sup>th</sup> century. The focus was on *sanitation*, i.e. limiting health impacts. By 1875, waste management was encoded at UK national level by the Public Health Act. Similar developments followed in Europe, in the USA and elsewhere, starting locally to later have state and national coverage.

Since heating was inevitably provided by fireplaces and stoves, combustible waste had always been used as a source of energy. However, in 1872, the first dedicated incinerator, named the

---

<sup>49</sup> The World's Scavengers: Salvaging for Sustainable Consumption and Production. Martin Medina. Altamira Press, UK, 2007.

<sup>50</sup> Waste Treatment and Disposal, Paul T. Williams, 2nd ed. John Wiley & Sons, Ltd, 2005

<sup>51</sup> Kenneth Barbalace. The History of Waste. EnvironmentalChemistry.com. Aug. 2003.

<sup>52</sup> <http://EnvironmentalChemistry.com/yogi/environmental/wastehistory.html>. Accessed August 2016.

<sup>52</sup> Development drivers for waste management. David C. Wilson. Waste Manage Res 2007: 25: 198–207

“Destructor” was built in the UK. It was soon followed by other units and at the time of WW I, there were several hundreds of incinerators in operation in the UK, USA and elsewhere. These were small and rather primitive units with the main purpose of reducing waste volumes and avoid biological activity, and mostly did not had energy recovery. However, landfilling remained as the main disposal method and due to its relatively high cost, incineration became less and less used in the post-war period. To reduce the nuisance of landfilling, site planning and management methods including covering of filled cells were developed, but open landfills were still common. Up to the 1960’ there were no new regulatory trends and the concern from the policy makers was more to enforce the regulations already adopted as illegal dumping was common.

However, in the 1960’ and 70’s, there was a growing concern regarding the impact of pollution on the *environment*, also affecting waste management beyond sanitization. The concern emanated from the realization of bio-accumulation of toxic materials, and the low rate of bio-decomposition of certain manufactured chemicals e.g. DDT. The concerns were further fuelled by a number of scandals involving illegal dumping, leakages from dump sites and industrial accidents in many countries (e.g. at Seveso, an accident that put the focus on dioxins<sup>53</sup>) that demonstrated the inadequacy of regulation and control.

Waste combustion, from incinerators and even more so from spontaneous or planned fires on landfills, were identified as a major source of dioxins, a toxic and extremely stable group of compounds, which had a direct effect on waste management. In general, emissions were seen as predominantly an effect of production and transformation processes, so policy measures (“Command-Control” policies) resulted in new regulations regarding limiting emission values to air and water. It also led to the control of the sources of pollution and related stakeholders, in particular in waste and hazardous waste generation and management. This developed further to also trying to define the state-of-the art technologies to be used for pollution control (“Technical fix” policies) leading to establishing Best Available Technology, BAT, and Maximum Available Control Technology, MACT as guidelines. These policies also tried to establish the responsibility for addressing environmental issues (*Precautionary Principle, Proximity Principle, Extended Producer Responsibility, Polluter Pays Principle*<sup>54</sup>).

The environmentalism eventually led into a different discussion on population growth, depletion of natural resources and the limits of economic growth and of an increased production of goods for consumption<sup>55</sup>. There was also the realization that many materials extracted or produced, with the exception of fuels and construction materials, would potentially end up as wastes after a short period of time<sup>56</sup> (climate change effect of fuel usage was yet not debated).

In the wake of this debate, also less resource-intensive consumption patterns and more resource-effective production methods came into focus, also including the possibility for re-using resources. Eventually the term *sustainability* came into use<sup>57</sup>. But, up to this time, the quantities of wastes and the composition of wastes had not been questioned. By the beginning of the 1980’s, although the actual origin is unclear<sup>58</sup>, also the so-called “3Rs” (reduce, re-use, re-cycle) or the “Waste Hierarchy” was formulated, Figure 19. This was soon taken aboard by policy makers and used as a framework for waste policies and regulation.

---

<sup>53</sup> Seveso accident: release of dioxins into the atmosphere in a chemical plant 10 July 1976. French Ministry of Environment - DPPR / SEI / BARPI N° 5620. February 2008. [www.aria.developpement-durable.gouv.fr/fiche\\_detaillee/5620\\_en/?lang=en](http://www.aria.developpement-durable.gouv.fr/fiche_detaillee/5620_en/?lang=en)

<sup>54</sup> Environmental Principles and Concepts. Organisation for Economic Co-Operation and Development (OECD). Paris 1995

<sup>55</sup> Limits of Growth. D. H. Meadows, D. L. Meadows, J. Randers, and William W. Behrens III. Universe Books 1972

<sup>56</sup> Production, consumption and externalities. R.U. Ayres, A. V. Kneese. Am. Econ. Rev., June 1969.

<sup>57</sup> World Conservation Strategy: Living Resource Conservation for Sustainable Development. International Union for Conservation of Nature and Natural Resources. 1980

<sup>58</sup> Limitations of the waste hierarchy for achieving absolute reductions in material throughput. S. Van Ewijk, J.A. Stegemann

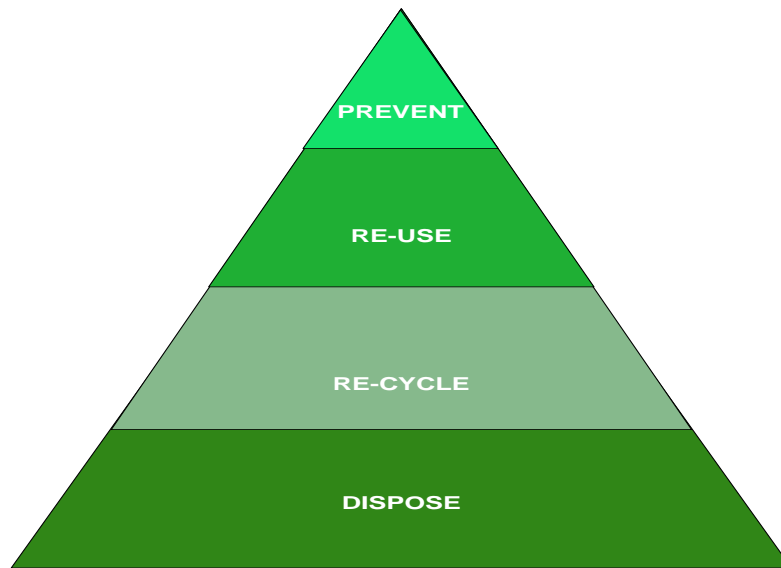

**Figure 19 The Waste Hierarchy<sup>59</sup>**

In addition, although predicted to some extent already at the turn of the 19<sup>th</sup>/20<sup>th</sup> century and discussed since among some scientists, a review<sup>60</sup> from 1972 made the concept of the “Greenhouse Effect” reach a wider audience. From the late 1970’s the impact of the use of fossil resources on the climate came increasingly also into the public debate. As a fraction of the wastes had fossil origins, while organic residues in landfills were decomposed anaerobically to release GHG-potent methane to the atmosphere, this linked the discussion on waste and sustainability to climate change. As a consequence, further control measures in waste management were introduced, in particular regarding landfills and landfill gas recovery.

The discussions on resource usage and depletion, an increasing global population, degradation of the environment by pollution as well as the risk of climate change created another concept, the “Circular Economy”<sup>61</sup>. This concept was formulated as a mean to develop society, both in practice and in thinking, towards re-using available resources and renewable energy to minimize the impact of production, as opposed to the prevailing “linear economy” characterized by “take, make, dispose”. In terms of waste management, the ideals of the circular economy are very much in line with the waste hierarchy and also put emphasis on that both internal and external costs should be considered for goods and services. This approach prescribes that already in the design phase, products and services are planned and manufactured to cause minimal burdens in terms of environmental impacts by being resource-effective and facilitating their re-use or re-cycle.

## **4.2. INTERNATIONAL POLICIES**

At the international (UN) level, there are few policy documents and regulations that directly focus on wastes. However, since the 1970’s, environmental issues have been on the agenda of the UN.

### **4.2.1. Policies**

The environmental concerns led to the first international policy conference on the topic, the UN Conference on the Human Environment in Stockholm, Sweden in 1972. The result was a resolution, the formulation of 26 guiding principles concerning the environment and development and 109

<sup>59</sup> There are many variations in the graph, the divisions and also the wording. The top represents the “highest”, most desirable level in the hierarchy. The graph is sometimes shown upside-down to the one depicted here.

<sup>60</sup> “Man-made Carbon Dioxide and the “Greenhouse” Effect”. J. S. Sawyer. *Nature*. 239: 23–26, 1972

<sup>61</sup> David W. Pearce, R. Kerry Turner. *Economics of Natural Resources and the Environment*. Johns Hopkins University Press, 1989

recommendations<sup>62</sup>, and also resulted in the formation of United Nations Environmental program, UNEP. A next step was the report<sup>63</sup> in 1987 from World Commission on Environment and Development: *Our Common Future*, aka "Brundtland commission" that formulated a widely used definition of sustainable development<sup>64</sup>.

The IPCC, Intergovernmental Panel on Climate Change<sup>65</sup>, was formed on the initiative of some UN member states by World Metrological Organisation (WMO) and UNEP in 1988 to provide scientific data on the mechanisms, effects and mitigation policies concerning climate change, and its reviews and forecasts has been debated but also used as background material for the UNFCCC convention and its protocols, see below.

In 1992 United Nations Conference on Environment and Development (UNCED)<sup>66</sup>,(aka Rio de Janeiro Earth Summit or Rio Conference) led to the formation of a Commission on Sustainable Development and adopted three major agreements aimed at changing the traditional approach to development:

- Agenda 21 — a program for global action in all areas of sustainable development;
- The Rio Declaration on Environment and Development defining the rights and responsibilities of States;
- The Statement of Forest Principles — a set of principles to underlie the sustainable management of forests worldwide.

Another conference, the World Summit on Sustainable Development (aka WSSD Earth Summit or Rio+10) was held in 2002 in Johannesburg, South Africa, and there was also a series of follow-up meetings in Rio de Janeiro, Rio+5 and Rio+20, but these were more follow-ups on the actions already taken.

The Millennium Summit<sup>67</sup> of the UN in 2000 established in the United Nations Millennium Declaration and defined the 8 Millennium Development Goals (MDGs) for the year 2015. One of these was to ensure environmental sustainability, one indicator being CO2 emissions per capita and per \$ of Gross Domestic Product (GDP). The reported data by 2012 indicate an increase by 50 % up to 2012<sup>68</sup>, whereas in many other areas, improvements are reported and many of the original goals were reached. In 2015, a post-2015 Development Agenda was formulated, "Transforming our world: the 2030 Agenda for Sustainable Development<sup>69</sup>", setting goals (SDG) for e.g. sustainable resource usage for production and consumption and climate change.

#### 4.2.2. Conventions

The original Stockholm conference and other activities have resulted in a number of conventions in the international field covering environmental issues, and where some have direct impact on waste management.

#### **The 1979 Geneva Convention on Long-range Transboundary Air Pollution (CLRTAP)<sup>70</sup>**

<sup>62</sup> <http://www.unep.org/Documents.multilingual/Default.asp?DocumentID=97&ArticleID=1503>

<sup>63</sup> World Commission on Environment and Development (1987). *Our Common Future*. Oxford: Oxford University Press.

<sup>64</sup> *Sustainable development is development that meets the needs of the present without compromising the ability of future generations to meet their own needs. It contains within it two key concepts:*

- *the concept of 'needs', in particular the essential needs of the world's poor, to which overriding priority should be given; and*
- *the idea of limitations imposed by the state of technology and social organization on the environment's ability to meet present and future needs.*

<sup>65</sup> <http://www.ipcc.ch/>

<sup>66</sup> <http://www.un.org/geninfo/bp/envirp2.html>

<sup>67</sup> [http://www.un.org/en/events/pastevents/millennium\\_summit.shtml](http://www.un.org/en/events/pastevents/millennium_summit.shtml)

<sup>68</sup> The Millennium Development Goals Report 2015. UN 2015

<sup>69</sup> Resolution adopted by the UN General Council on September 25, 2015.

<https://sustainabledevelopment.un.org/post2015/transformingourworld>

<sup>70</sup> [http://www.unece.org/env/lrtap/lrtap\\_h1.html](http://www.unece.org/env/lrtap/lrtap_h1.html)

The Convention on Long-range Transboundary Air Pollution was the first international legally binding instrument to deal with problems of air pollution with the intent to gradually reduce and prevent air pollution, including long-range transboundary air pollution. The convention entered into force in 1983 and has at present 51 parties in the northern hemisphere, including the EU member states, EFTA states, Balkan states, Turkey, the states of the FSU as well as USA and Canada. The convention calls for the set-up of an inventory of emission point sources and associated emission reporting. It has later been extended by eight specific protocols. These protocols contain binding commitments on:

- applying as a minimum defined limiting emission levels (LEV) for a variety of point emission sources.
- implementing of specified improved techniques (BAT).
- national emission ceilings for SO<sub>2</sub>, NO<sub>x</sub>, NH<sub>3</sub>, VOC to be attained by 2010.

Protocols has since been amended to set targets for 2020, and to also include particulate matter (PM<sub>2.5</sub>) that affects both health and the climate.

**The 1989 Basel Convention on the Control of Transboundary Movements of Hazardous Wastes and their Disposal**<sup>71</sup> The main purposes are the reduction of hazardous waste generation and to establish environmentally sound management of wastes arising and to restrict movement of such wastes across borders unless sufficient regulatory controls are available. It also calls for an overall reduction of waste generation.

**The 1992 UN Framework Convention on Climate Change 1992**<sup>72</sup>. UNFCCC was adopted at the Rio Earth Summit 1992 as a part of Agenda 21 and came into force 1994. It is supported by IPCC, the Intergovernmental Panel on Climate Change. This is done by, among other things, preparing so-called Assessment Reports, the latest version<sup>73</sup> of which covering waste management was published in 2014. The convention is supported by separate agreements that calls for actions to reduce GHG emissions to stabilize the temperature rise such as the **Kyoto protocol** of 1997 coming into force in 2005 and the **Paris Agreement**<sup>74</sup> of 2015, entered into force in November 2016 after being ratified by 55 countries (USA not being one of these).

**The 2001 Stockholm Convention on Persistent Organic Pollutants**<sup>75</sup> (POPs)

The convention came into force 2004 to protect human health and the environment from POPs by the elimination or restriction of production and use of all intentionally produced POPs (i.e. industrial chemicals and pesticides, later also PCB and PFOS have been added) as well as minimization of the releases by preventive measures to reduce emissions etc. and from unintentionally produced POPs such as dioxins and furans.

Other conventions that are connected to more general environmental practices with implications for waste management include:

**The Vienna Convention for the Protection of the Ozone Layer 1985**<sup>76</sup> led to the **Montreal Protocol** in 1987 to protect the ozone layer by a phase-out of CFC and HCFC compounds and the **Kigali amendment** of 2016 dealt with the phase-out of the substitute HFC compounds, which are not detrimental to the ozone layer but are very potent GHG gases.

---

<sup>71</sup> <http://www.basel.int>

<sup>72</sup> <http://newsroom.unfccc.int/>

<sup>73</sup> Climate Change 2014: Mitigation of Climate Change, IPCC.

<sup>74</sup> [http://unfccc.int/paris\\_agreement/items/9485.php](http://unfccc.int/paris_agreement/items/9485.php)

<sup>75</sup> [www.pops.int](http://www.pops.int)

<sup>76</sup> <http://ozone.unep.org/en/handbook-vienna-convention-protection-ozone-layer/2205>

### **The 1991 EIA Espoo Convention on Environmental Impact Assessment<sup>77</sup>**

The convention defines the obligations to assess the environmental impact of certain activities and a general obligation of states to notify and consult each other on all major projects that have a significant adverse cross-boundary environmental impact, including waste management installation treating more than 100 ton/day.

**The 1998 Aarhus Convention on Access to Environmental Information, Public Participation in Environmental Decision-making and Access to Justice in Environmental Matters<sup>78</sup>** that covers the relationship and interactions between people and governments in the area of environmental protection in terms of accountability, transparency and responsiveness.

## **4.3. EU POLICY AND REGULATIONS**

The current EU traces its roots to the Treaty of Rome in 1957, prior to that environmental issues and sustainability became a part of the public debate or policy-making and were not included in the European Community common responsibilities<sup>79, 80, 81</sup>. The rise in environmental awareness and in the wake of the UN Stockholm conference led to policy initiatives from the EC, but limited to specific issues (radiation, vehicle emissions, etc.), where it could be legally argued that the EC objective of a common internal market could benefit from supranational regulations. However, it was not until 1987 by the Single European Act, and via the formation of the EU in the Maastricht Treaty in 1992 gave the EC stronger powers in this area. This latter treaty established a legal basis for environmental policy initiatives and legislation by the European Commission, including entering into binding international agreements, but environment was only one of the policy objectives. This role of the Commission in relation to the subsidiary principle was challenged by some member states in the years to come. However, in the Amsterdam Treaty in 1997, it was agreed that environmental protection should be strengthened to be integrated into all other community policies and sustainable development was made an objective.

From the 1970's and onwards, initially more based on intergovernmental agreements than on initiatives by the commission itself, an Environment and Consumer Protection Service organization was founded, and in 1981 DG IX, the predecessor to DG Environment. Environmental policies were adopted in a series Environmental Action Plans (EAP) from the first one in 1973 up to the 7<sup>th</sup> EAP, 2013-2020. The initial action plans contained a broad set of principles and objectives and focused on maintaining certain standards for air and water quality. These plans have gradually developed to specific policies to prevent and reduce emissions by limits, requirements for EIA and to apply an integrated approach for permitting based on BAT and the benefits of a multi-stakeholder approach. The later plans also include issues like climate change, introduced in the 5<sup>th</sup> EAP 1993-2001, and define sustainable development as the policy objectives. In this respect, waste has shifted from being a mere source of emissions, requiring directions on its management and preventing illegal (transboundary) trade, in the earlier EAPs, later EAP waste policies explicitly refer to the Waste Hierarchy and in the 7<sup>th</sup> EAP, the waste is seen as a resource<sup>82</sup>. The policies have also been translated into a number of legal acts, see section 4.3.1.

In parallel to these environmental policies, there are also horizontal policy initiatives with implications for waste e.g. in the climate policies and regarding developing circular economy.

<sup>77</sup> <http://www.unece.org/env/eia/eia.html>

<sup>78</sup> <http://www.unece.org/env/pp/welcome.html>

<sup>79</sup> D.C. Smith. EU Environmental Law: From Absence (1957) to Sustainable Development (1992) to Corporate Social Responsibility (2004). Jean Monnet/Robert Schuman Paper Series Vol.5 No. 4, February 2005

<sup>80</sup> Emanuela Orlando. The Evolution of EU Policy and Law in the Environmental Field: Achievements and Current Challenges. TransWorld Working Paper 21, April 2013

<sup>81</sup> EU Environmental Handbook, European Environmental Bureau 2005. [http://www.eeb.org/publication/policy\\_handbook.html](http://www.eeb.org/publication/policy_handbook.html)

<sup>82</sup> DECISION No 1386/2013/EU OF THE EUROPEAN PARLIAMENT AND OF THE COUNCIL of 20 November 2013 on a General Union Environment Action Programme to 2020 'Living well, within the limits of our planet'



In the EU, the climate change policies<sup>83</sup>, <sup>84</sup> were first discussed by the European Council in Dublin 1990, after IPCC had published its first Assessment Report, as a preparation for the UNFCCC negotiations. The aim was to achieve the 1990 GHG emission levels again in 2000, but not giving policy directions. This lack of policy guidance led to a debate from which came three themes: reduction of GHG emissions, promotion of renewable energy and of energy efficiency. An initial effort to impose CO<sub>2</sub> taxation failed due to resistance from some member states. A program, later supported by a directive, Specific Actions for Vigorous Energy Efficiency, (SAVE) was initiated in 1991, but other policies were not emerging until the end of the 1990's, while the Kyoto Protocol was only agreed in 1997. A voluntary agreement with the automotive industry on limiting emissions was entered in 1998, whereas an action to reduce emissions from waste disposal, the Landfill Directive, see below, was adopted 1999 while a directive on the promotion of electricity from renewable sources was prepared and adopted in 2001. To prepare for the Kyoto protocol coming into force the commissions established the European Climate Change Programme (ECCP)<sup>85</sup> in 2000. This was a mean to, via a multi-stakeholder consultative process, identify the most effective policies to reduce the EU GHG emissions to ensure that the committed 8 % reduction to 2012 under the Kyoto Protocol was met. By the time the Kyoto Protocol came into force in 2005, numerous policy initiatives had been undertaken in this direction. The most important ones were the EU Emission Trading Scheme<sup>86</sup>, the Directive on promotion of Combined Heat and Power, the Directive on energy performance of buildings and the Directive on Promotion of Transport Biofuels<sup>87</sup>. ECCP II was launched in 2005 with the goal of identifying other means to reduce GHG emissions such as in agriculture, from carbon capture and geological storage, from light-duty vehicles and aviation CO<sub>2</sub> emissions, as well as adaptation to the effects of climate change. One of the key outcomes was the potential of, and need for measures to promote, renewable heating and cooling.

In response to the second commitment period under the Kyoto Protocol, the 2020 package was launched in 2008. The package sets three key targets to be achieved by the EU in 2020:

- 20 % cut in greenhouse gas emissions (from 1990 levels)
- 20 % of EU energy from renewables
- 20 % improvement in energy efficiency

It also included corresponding but differentiated national targets. The measures include the third phase of the ETS system<sup>88</sup>, promotion of Renewable energy (RED<sup>89</sup>) and the CCS directive<sup>90</sup>. The ETS system<sup>91</sup> is a cap and trade system trading in emission rights for CO<sub>2</sub>, the number of which are gradually decreased over time to drive developments in GHG reducing processes and industries. Emission rights are either obtained for free in proportion to the activities or are purchased by auctioning, see also below in this section. The ETS sector covers 13 000 fixed installations involved in power and energy generation above 20 MW aggregated input, and manufacturing industries which are significant users of energy, plus the aviation sector since 2012. However, as the general rule it does not apply to waste incinerators, unless integrated into an industry but applies to waste co-combustion plants. The details of the fourth phase of the ETS system, covering 2021 to 2030 was agreed in the beginning of 2018.

---

<sup>83</sup> 'The EU and Climate Change Policy: Law, Politics and Prominence at Different Levels', Damro, C., Hardie, I and MacKenzie, D. Journal of Contemporary European Research, Vol. 4, No. 3, pp.179-192, 2008.

<sup>84</sup> European Climate Policy - History and State of Play. A. Prahli, E. Hofmann. Climate Policy Info Hub, 14 November 2014. <http://climatepolicyinfohub.eu/european-climate-policy-history-and-state-play>

<sup>85</sup> [http://ec.europa.eu/clima/policies/eccp/index\\_en.htm](http://ec.europa.eu/clima/policies/eccp/index_en.htm)

<sup>86</sup> 2003/87/EC

<sup>87</sup> 2003/30/EC

<sup>88</sup> Consolidated 2003/87/EC including 2004/101/EC, 2008/101/EC, Regulation (EC) No 219/2009, 2009/29/EC, Regulation (EU) No 421/2014

<sup>89</sup> 2009/28/EC

<sup>90</sup> 2009/31/EC

<sup>91</sup> [http://ec.europa.eu/clima/policies/ets/index\\_en.htm](http://ec.europa.eu/clima/policies/ets/index_en.htm)

The Europe 2020 Strategy<sup>92</sup> presented in 2010, in addition to giving targets for climate emissions and energy, also gives targets for wastes, such as e.g. to reduce the per-capita waste generation by 2020, to virtually eliminate landfilling and to only apply energy recovery to non-recyclable materials. In 2011 a strategy<sup>93</sup> for resource efficiency and a road-map<sup>94</sup> to 2020 was published.

The most recent policy decision is the 2030 Climate and Energy Framework<sup>95</sup> adopted by EU leaders in October 2014. It sets three key targets for the year 2030<sup>96</sup>:

- At least 40% cuts in greenhouse gas emissions (from 1990 levels)
- At least 27% share for renewable energy (increased to 32 % in 2018 as part of the end negotiations on the renewable energy directive RED II directive)

The reductions in GHG is to be achieved by 43 % in the ETS sector, 30 % in other sectors, including waste management, and the balance by increasing renewable energy and by means of increasing the energy efficiency. The policy statements and targets for 2030 have been formalized as legislation for the period 2021-2030, e.g. the 4th phase of ETS<sup>97</sup>, RED II<sup>98</sup> and other directives.

The longer term perspective is also included by the Roadmap for moving to a competitive low carbon economy in 2050<sup>99</sup>, the Energy Roadmap 2050<sup>100</sup> and the Transport White Paper<sup>101</sup>.

Also, on the waste and resource efficiency there are initiatives with a longer time horizon than 2020. In 2016, the commission adopted a Circular Economy Package<sup>102</sup>, which includes revised legislative proposals on waste management and targets for recycling.

#### 4.3.1. Directives

The EU common policies discussed above have been translated into a number of legal acts (*Regulations* that are to be applied as written by all member states, *Directives* that contains objectives, modalities and quantified elements (goals, limits etc.) that requires incorporation into the member state laws and legal system, *Decisions* that are binding on the receivers, which could be from an individual legal entity to one or more member states, *Recommendations* that are non-binding opinions, and interpretations and *Communications* that states policy intentions). The overall legal and regulatory system of waste management and recovery in the European Union is shown in Figure 20. The regulatory considerations for waste treatment installations in general, but also including waste-fuelled gasification plants, are mainly controlled by a first tier of EC directives that are imposed into member state law and by-laws in second and third tiers. Below, the most important directives of relevance for this report are discussed.

<sup>92</sup> EUROPE 2020. A strategy for smart, sustainable and inclusive growth. COM(2010) 2020 final

<sup>93</sup> A resource-efficient Europe – Flagship initiative under the Europe 2020 Strategy. COM(2011) 21, 2010

<sup>94</sup> Roadmap to a Resource Efficient Europe. COM(2011) 571. 2011

<sup>95</sup> [http://ec.europa.eu/clima/policies/strategies/2030/index\\_en.htm](http://ec.europa.eu/clima/policies/strategies/2030/index_en.htm)

<sup>96</sup> However, all the targets above have not yet been fully formalized legally, and changes have been or will be made due to the ongoing trilogue (EC, EP and MS) negotiations.

<sup>97</sup> Directive (EU) 2018/410 amending Directive 2003/87/EC to enhance cost-effective emission reductions and low-carbon investments, and Decision (EU) 2015/1814

<sup>98</sup> RED II directive, as agreed June 2018 Interinstitutional File: 2016/0382 (COD)

<sup>99</sup> COM (2011) 112: A Roadmap for moving to a competitive low carbon economy in 2050

<sup>100</sup> Energy Roadmap 2050 [COM/2011/885

<sup>101</sup> WHITE PAPER Roadmap to a Single European Transport Area – Towards a competitive and resource efficient transport system. COM/2011/0144 final

<sup>102</sup> Closing the loop - An EU action plan for the Circular Economy. COM/2015/0614 final

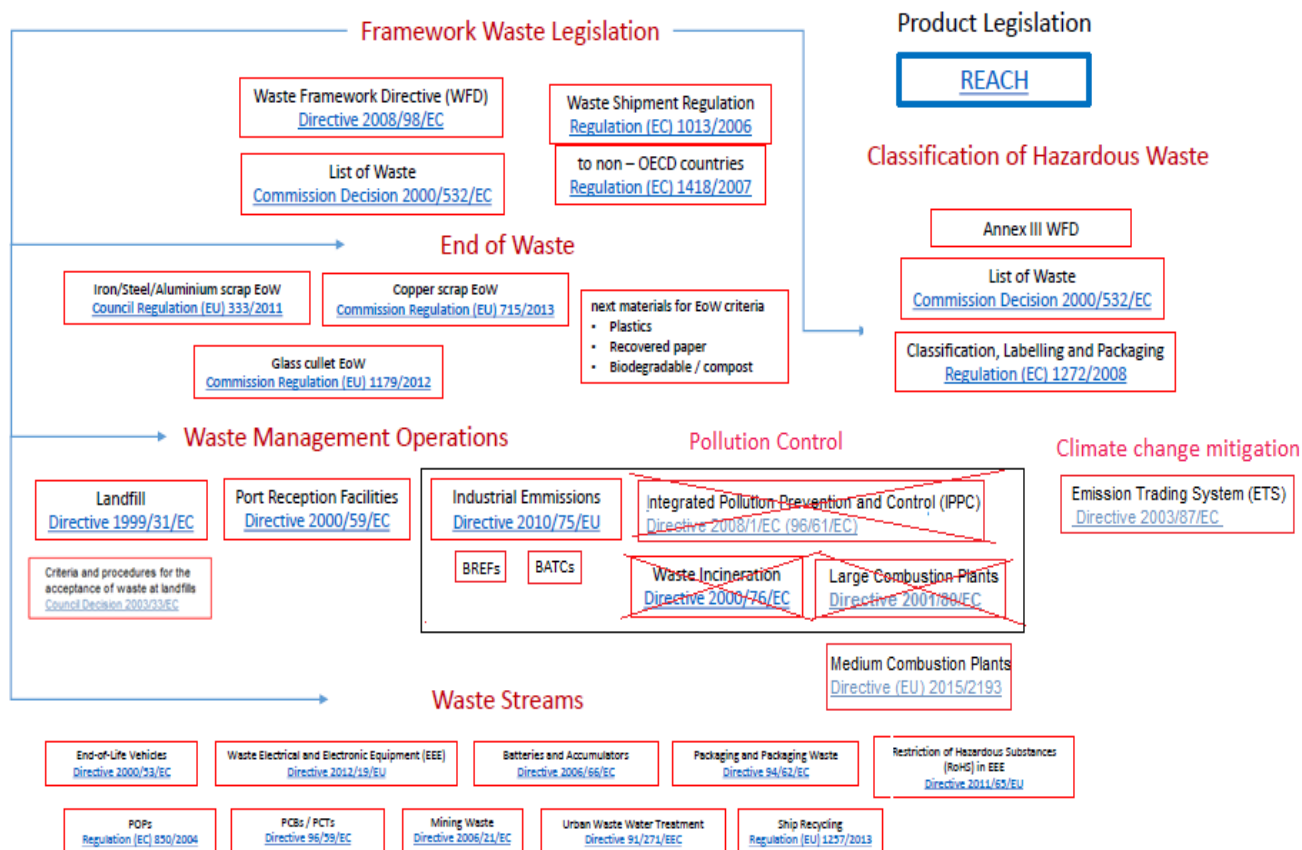

**Figure 20 Overview of EU legislation discussed (Adapted from<sup>103</sup>)**

**1991/31/EC Landfill Directive<sup>104</sup> (LFD)**

The objective of this directive is to prevent or reduce as far as possible negative effects on the environment from the landfilling of waste by introducing stringent technical requirements for waste and landfills. Permits, based on specified information requirements listed for different classes of landfills, are required. It defines the categories municipal waste, hazardous waste, non-hazardous waste and inert waste and the respective requirements for prior pre-treatment as well as acceptance for pre-treated waste into the different classes of landfills.

In quantitative terms, the directive required that national strategies should be developed by 2003 to include measures and pre-treatment technologies to reduce biodegradable municipal waste going to landfill to 35 % of 1995 levels by 2016 but with a caveat for member states landfilling more than 80 % in 1995 to delay goal attainment by up to four years. A follow-up in 2014<sup>105</sup>, relating to the Circular Economy Package<sup>102</sup>, indicated that 23 member states were on track, while in 5 member states, additional efforts were required. Some member states like Austria, Germany, Netherlands and Sweden have in their national legislation gone further by banning landfilling of recoverable, combustible or even organic wastes.

New targets are being proposed as part of the amendment<sup>106</sup> to ensure that by 2030 the amount of municipal waste landfilled is reduced to 10% of the total amount of municipal waste generated.

<sup>103</sup> EuRIC: EU laws. <http://www.euric-aisbl.eu/facts-figures/eu-laws>

<sup>104</sup> [http://ec.europa.eu/environment/waste/landfill\\_index.htm](http://ec.europa.eu/environment/waste/landfill_index.htm)

<sup>105</sup> SWD(2014) 207 final

<sup>106</sup> 2015/0274 (COD)

There is also some ancillary legislation relating to landfilling of waste and where in particular the acceptance criteria for wastes to landfills<sup>107</sup> has implications for waste incineration and gasification as this would apply to ashes or other solid by-products from such facilities, and with potential cost implications for the disposal of such materials.

### **2010/75/EC - Industrial Emissions Directive (IED)**

The history of this directive, which became fully in force in 2015, is that it is a revised amalgamation of a series of earlier directives, notably the Integrated Pollution Prevention and Control (IPPC) directive, dealing with the permitting of industrial installations and the application of BAT as the leading principle to set the requirements, the Waste Incinerator Directive<sup>108</sup> (WID) and Large Combustion Plant Directive<sup>109</sup> (LCP) as well as four other sectorial directives<sup>110</sup> not relevant for this study. These directives define the operating conditions and limiting emission values of different pollutants to air and water for these specific industries. The list of installations covers many industrial and agroindustrial activities and represents a total of some 50 000 installations within the EU. In addition, it is also the main EU instrument regulating pollutant emissions from some specific industrial installations.

The definitions distinguish between wastes that are "biomass" and other wastes, the former being exempt from the provisions for incinerators in this directive, 'biomass' means any of the following:

(a) products consisting of any vegetable matter from agriculture or forestry which can be used as a fuel for the purpose of recovering its energy content;

(b) the following waste:

- (i) vegetable waste from agriculture and forestry;
- (ii) vegetable waste from the food processing industry, if the heat generated is recovered;
- (iii) fibrous vegetable waste from virgin pulp production and from production of paper from pulp, if it is co-incinerated at the place of production and the heat generated is recovered;
- (iv) cork waste;
- (v) wood waste with the exception of wood waste which may contain halogenated organic compounds or heavy metals as a result of treatment with wood preservatives or coating and which includes, in particular, such wood waste originating from construction and demolition waste;

In Chapters I and II of the consolidated directive, and its associated annexes, the IED lists the general principles for the permitting, start-up, operation, disturbed operation, shut-down, monitoring control and inspections of industrial installations based on an integrated approach and the application of best available techniques (BAT) as leading principle. It also states that guidance documents (BREFs and BATCs, see below) will be developed to assist industries and authorities. It also sets out the principles of the interactions between installation owners, public bodies and the public itself. Relating to wastes, in Article 4, it is stated that combustion, incineration and co-incineration plants must hold a permit from the competent authority in the member state. It also lists types of biomass wastes, for which the Chapter IV on waste incinerators does not apply<sup>111</sup>.

In **Chapter III** and associated annexes, the permitting, operating and minimum limiting emission levels for **large combustion plants** (LCP, > 50 MW thermal, typically various forms of power and

<sup>107</sup> COUNCIL DECISION of 19 December 2002 Criteria and procedures for the acceptance of waste at landfills pursuant to Article 16 of, and Annex II, to Directive 1999/31/EC (Council Decision 2003/33/EC)

<sup>108</sup> 2000/76/EC

<sup>109</sup> 2001/80/EC

<sup>110</sup> 1999/13/EC on activities using organic solvents, 78/176/EEC, 82/883/EEC and 92/112/EEC, concerning titanium dioxide production.

<sup>111</sup> i.e. vegetable waste from agriculture and forestry; vegetable waste from the food processing industry if the heat generated is recovered; fibrous vegetable waste from virgin pulp production and from production of paper from pulp if it is co-incinerated at the place of production and the heat generated is recovered; cork waste; wood waste with the exception of wood waste which may contain halogenated organic compounds or heavy metals as a result of treatment with wood preservatives or coating and which includes, in particular, such wood waste originating from construction and demolition waste

CHP plants but excluding waste incineration and some other specific production installations which are regulated separately), are set out. It also covers gasification of coal and other fuels (except oil gasification within a refinery) in installations with a total rated thermal input of 20 MW or more, but only when this activity is directly associated to a combustion process including gas turbine combined cycles. For solid biomass and for a general, unspecified gaseous fuel such as derived from a gasification plant, the limiting emission values for LCPs are given in Appendix 2, Tables A2.1.

**Chapter IV** is devoted to waste incineration and co-incineration plants. The main applicability of the conditions is for plants using more than 3 tons/h of waste (approximately 10-20 MW thermal depending on the waste), but it excludes R&D units up to a capacity of 50 tons/year, i.e. pilot plants consuming more than the above quantity are seen as incinerators and needs permits, even if the full conditions of the EID would not necessarily apply.

The term incinerator<sup>112</sup> or co-incinerator<sup>113</sup> in this context also covers other forms of thermal treatment than combustion (oxidation) such as gasification and pyrolysis units or plasma treatment, but only "if the substances resulting from the treatment are subsequently incinerated", i.e. if the thermal treatment is linked to a downstream incineration or co-incineration unit (i.e. boiler, gas turbine, gas engine or furnace), which is then also included within the boundaries of the incinerator or co-incinerator. The IED clearly limits its applicability to the conditions that the gas, the substance generated, is "incinerated", and if this is related to energy recovery or to produce materials (e.g. cement). If other fuels are involved as the main or a minor fuel in parallel to the gasification gas, it distinguishes between incineration and co-incineration.

A waste gasifier or co-gasifier making a material product, e.g. a synthesis fuel from waste such as is the case in e.g. the Enerkem plant does not fall within the scope of this directive (flaring or use of some fuel gas for e.g. steam generation could be a situation where such a plant, at least partially, again falls into the EID).

However, if the gases resulting from this thermal treatment of waste in gasification or pyrolysis plants are purified prior to the incineration to such an extent that "cannot give emissions higher than those resulting from the burning of natural gas", the gases are no longer a waste, i.e. the provisions of the waste incinerator chapter are not applicable for any subsequent use of the gas in a combustion process. But, the gasification system up to achieving the "end-of-waste" cleanliness of the product gas is still an incinerator (or co-incinerator).

The permit conditions, apart from that the installation is made according to the other provisions in the directive, require that energy should be recovered as far as practically possible. Regarding the operation, there are several conditions on the control and record-keeping of the waste used, as well as on the need for inspections and permit reviews.

There are also some more detailed operational requirements;

- For missions to the air and water are capped by limiting emission values (LEVs).
- On measurement of emissions and for record-keeping of such measurements and other operational data.
- That an incinerator must have a residence time for the gases generated of 2 s at least 850

---

<sup>112</sup> 'waste incineration plant' means any stationary or mobile technical unit and equipment dedicated to the thermal treatment of waste, with or without recovery of the combustion heat generated, through the incineration by oxidation of waste as well as other thermal treatment processes, such as pyrolysis, gasification or plasma process, if the substances resulting from the treatment are subsequently incinerated.

<sup>113</sup> 'waste co-incineration plant' means any stationary or mobile technical unit whose main purpose is the generation of energy or production of material products and which uses waste as a regular or additional fuel or in which waste is thermally treated for the purpose of disposal through the incineration by oxidation of waste as well as other thermal treatment processes, such as pyrolysis, gasification or plasma process if the substances resulting from the treatment are subsequently incinerated.

- °C after the final injection of air.
- To have support burners to keep the above temperature, as necessary.
- That the control system should automatically stop feeding wastes if the temperature drops below this level or if the emission control fails to meet the emission limits.
- That the bottom ash residues should not have more than 3 % by weight of organic carbon or a LOI (Loss of Ignition) below 5 %.
- That the waste incineration plant or waste co-incineration plant or individual furnaces being part thereof shall under no circumstances continue to incinerate waste for a period of more than 4 hours uninterrupted where emission limit values are exceeded.
- That the cumulative duration of operation in such conditions over 1 year shall not exceed 60 hours.
- That, in the case of a breakdown, the operator shall reduce or closedown operations as soon as practicable until normal operations can be restored.

In terms of gasification of waste, the IED Chapter IV requirements have impact on the design of a gasification system for waste, relative to e.g. clean biomass, with regard to e.g. start-up and flaring.

The data for flue gas emission limit requirements for waste incinerators are given in Appendix 2, Table A.2.2. There are also emission limits for water effluents from incinerators. Furthermore, emissions to the air from the flue gas and also selected operating parameters should be continuously monitored by an automated and accredited system, with the exception of heavy metals, dioxins and furans, which require 2-4 samples per year. Overall, this emission monitoring is quite demanding and comes with an appreciable annual cost. This requirement is the same for all incinerators independently of their capacity, therefore the associated cost weighs more heavily on smaller capacity installations than for larger ones.

The introduction of an end-of-waste definition for gasification units relating to the contaminants and emission potential of the gas eliminates a non-technical barrier that has been the cause for debate in the past. The original WID<sup>108</sup> did not contain the last by-sentence of the co-incineration definition or defined any the end-of-waste condition whatsoever. This led to two cases in the European Court of Justice referring to the gasification co-firing and CHP installations at Lahti Finland, see Section 7.2.2. In the first case<sup>114</sup> in 2008, relating to the gasification of waste, the purification of the gas generated as a product and the subsequent use of the product in a combustion unit, the ruling stated that a gaseous substance could not be considered a waste based on the definition in the WID, that the gasification unit should be seen as co-incineration unit as the installation had the purpose of producing a product (the fuel gas), and that the downstream combustion unit using the product then was not an incinerator.

On receiving this ruling, Lahti Energia then went further to have the court decide<sup>115</sup> if the use of a waste gasifier, but in this case producing non-purified gas as a co-firing fuel into a mainly fossil-fired boiler, would mean that the boiler would not be a co-incinerator as defined in the WID. The basis was that the previous ruling concluded that a gaseous substance was not a waste, as meant in the WID, and that, nevertheless, the gas did not constitute the major energy input to the combustion boiler. Hence, the combustion boiler could not be seen as a waste incinerator. The ECJ did not accept the argument and stated that there is a link between the waste gasifier and the combustion boiler that makes the entire complex a co-incinerator with respect to the WID definition, and furthermore, justifies this by referring to a recital of the WID stating that "the co-incineration of waste in plants not primarily intended to incinerate waste should not be allowed to cause higher emissions of polluting substances in that part of the exhaust gas volume resulting from such co-

---

<sup>114</sup> ECJ Case C-317/07

<sup>115</sup> ECJ Case C-209/09

incineration than those permitted for dedicated incineration plants” and notes “ that the harmful substances produced by the thermal treatment, commenced in the gas plant, to which the waste has been subjected are released and are discharged, at least in part, only when the crude gas has been transferred to the power plant.”

In practice, a gasification plant providing a gaseous energy carrier that has been cleaned to a quality that with regard to emissions are equal to natural gas most likely eliminates the need for any post-combustion cleaning completely. The Lathi CHP plant is therefore also a co-incinerator, as only part of the gas cleaning (halogens, dust heavy metals etc.) is upstream of the combustion boiler while other control measures are made on the flue gas (SO<sub>x</sub>, NO<sub>x</sub>).

#### Ancillary instructions and legislation.

The IED defines that permits for industrial activities should be based of BAT (Best Available Technology). To define and inform of the state-of-the-art, the European Integrated Pollution Prevention and Control (EIPPC) Bureau<sup>116</sup> produces Best Available Techniques Reference Documents (BREFs) for a large number of industries and industrial procedures covered by the directive (in 2017 there are 32 BREFs available). These BREFs contains a description of the state-of-the art of the technology and the pollution control in use, performance and cost data. It also concludes on what the best available control technology and practices and their performance are. The BREFs are to be updated every 8 years, and existing installations should adapt to a new BREF within 4 years after its adoption. When a BREF has been adopted, the BAT conclusions are further reinforced by a Commission Decision on these conclusions, BATC, i.e. makes these binding for e.g. the member states.

At present both the Large Combustion Plants and the Waste Incinerator are covered by BREFs, but both these documents are undergoing revisions. For the LCP BREF a final draft<sup>117</sup> was issued in June 2016. Regarding gasifiers, it has a BAT general provision of the energy utilization of 98 % of the fuel energy for gasification and boiler units without gas pre-treatment and 91 % for units with gas pre-treatment, including IGCC plants. The WID BREF work is on-going<sup>118</sup> and a first draft was available in May 2017 and a final draft is expected during 2018. The current status of the reference to waste gasification is not known, the text in the first draft seemed to only be marginally updated relative to the 2006 BREF.

#### **2008/98/EC Waste Framework Directive (WFD)<sup>119</sup>**

This directive was part of an over-haul on previous waste legislation and superseded the original waste directive<sup>120</sup> from 1975 and the latter 2006 version with consolidated amendments<sup>121</sup>, the hazardous waste directive<sup>122</sup> from 1991 and the 1975 waste oils directive<sup>123</sup>. Even if not directly dealing with the thermal conversion, this directive is important as it places energy recovery (R1) and material recovery (R3) into the order of the Waste Hierarchy, and in the case of energy recovery to heat and power it also gives a criterion to be achieved to meet R1 status. In addition, it defines end-of-waste as an option for recovered and recycled materials that is applicable also to a gasifier product gas, if certain technical criteria are met (as e.g. defined for cleaned gas in the EID discussed above).

<sup>116</sup> <http://eippcb.jrc.ec.europa.eu/reference/>

<sup>117</sup> Best Available Techniques (BAT) Reference Document for Large Combustion Plants. Industrial Emissions Directive 2010/75/EU (Integrated Pollution Prevention and Control). Final Draft (June 2016). JOINT RESEARCH CENTRE Institute for Prospective Technological Studies Sustainable Production and Consumption Unit. European IPPC Bureau

<sup>118</sup> KICK-OFF MEETING FOR THE REVIEW OF THE REFERENCE DOCUMENT ON THE BEST AVAILABLE TECHNIQUES FOR WASTE INCINERATION SEVILLE, 19 – 22 January 2015. JOINT RESEARCH CENTRE Institute for Prospective Technological Studies Sustainable Production and Consumption Unit. European IPPC Bureau. Ares(2015)1827228 - 29/04/2015

<sup>119</sup> <http://ec.europa.eu/environment/waste/legislation/a.htm>

<sup>120</sup> 75/442/EEC

<sup>121</sup> 2006/12/EC

<sup>122</sup> 91/689/EEC

<sup>123</sup> 75/439/EEC

It defines the basic principles of waste management, i.e. that it should not cause danger or nuisances for the surrounding environment and society. This directive also in legislation defines the waste hierarchy, see Figure 19, as the guiding principle for policy and permitting with the objective of, primarily, reducing the quantity of waste in society in general terms by prevention, and following this but less desirable, reuse and recycling, as well as lower in the hierarchy, recovery, thereby reducing the quantity of waste going to final disposal. Disposal is then associated with various restrictions such as e.g. the Landfill Directive or the ELV directive. In the annexes, there are also definitions of a number of different types of disposal and recovery operations (D1-D15 and R1-R13, respectively).

The directive also defines in general terms the conditions for when a waste that has undergone some recovery or recycling operation ceases to be a waste (end-of-waste criteria)<sup>124</sup>. However, the criteria need to be verified by for each particular type of by-product by a methodology developed by the EC<sup>125</sup>).

Regarding the energy use of municipal solid wastes (i.e. is not related to e.g. industrial and other forms of wastes, and also limited to power and heat applications and not considering e.g. waste-to-fuels), incineration without any, or insufficient, energy recovery is seen as D1 "disposal", i.e. at the same level as landfilling in the waste hierarchy. The directive also defines a numeric key (Figure 21), the minimum "Energy efficiency", for a waste-to-energy (WtE) incinerator (or similar process including gasification and pyrolysis, see IED) to classify as "energy recovery", R1. The threshold minimum of this key is 0.60 for plants permitted before 2009 and raised to 0.65 for plants permitted thereafter.

$$\text{Energy efficiency} = \frac{(GWh_e * 2.6 + GWh_{th} * 1.1 - GWh_{f+i})}{0,97 * (GWh_w + GWh_f)} > 0.65$$

**Figure 21 Energy recovery efficiency formula of WFD**

*Legend (figures on an annual basis): GWh<sub>e</sub> = electric production, gross; GWh<sub>th</sub> = heat production, gross; GWh<sub>f+i</sub> = consumption of conventional fuels and imported energy (e.g. waste heat from other sources); GWh<sub>w</sub> = annual consumption of waste fuel; GWh<sub>f</sub>: annual consumption of conventional fuel*

The formula is designed to give a relation between the incinerator and an assumed average European coal-fired power and heat generation, seen as the alternative to generate the corresponding output of power and heat as the WtE installation. Note that it is the output, i.e. gross generation that is used for the key, so that a plant with high internal consumption may still qualify as R1.

The formula has its main impact on MSW incinerators only producing electrical energy, whereas state-of-the-art CHP and heat only incinerators pass the threshold efficiency more easily. This is exemplified by using more conventionally energy efficiency numbers (in this estimate, the special case of use of a conventional fuel and import of energy has been disregarded) as shown in Table 7.

<sup>124</sup> The substance or object is commonly used for specific purpose); there is an existing market or demand for the substance or object; the use is lawful (substance or object fulfils the technical requirements for the specific purposes and meets the existing legislation and standards applicable to products); and the use will not lead to overall adverse environmental or human health impacts.

<sup>125</sup> [http://ec.europa.eu/environment/waste/framework/end\\_of\\_waste.htm](http://ec.europa.eu/environment/waste/framework/end_of_waste.htm)



**Table 7 "Energy Efficiency" factor for some waste incinerator types**

Waste CHP Technology	Gross El. power produced (% of input energy)	Gross heat produced (% of input energy)	"Energy Efficiency" factor
Limiting waste incinerator, power only	26 (24)	0 (0)	<b>0.65</b> <b>(0.60)</b>
Limiting waste incinerator, heat only	0	57	<b>0.65</b>
Typical waste incinerator CHP, w/o flue gas condens.	25	60	<b>1.35</b>
Typical waste incinerator CHP, w. flue gas condens.	25	65	<b>1.41</b>
Lahti-type waste gasification CHP	31	56	<b>1.47</b>

A new incinerator producing only power or only heat, according to the formula, must have energy efficiencies greater than 26 % and 57 %, respectively. State of the art, typical, waste CHP plants as operated e.g. in Sweden or Denmark will meet the criteria with considerable margin. Using gasification such as is done in e.g. the Kymijärvi II plant (see Section 7.3.2.4) would, due to the higher efficiency in the power cycle, also meet the R1 criteria, both as a power only unit and as a CHP plant. Also, for small scale gasification plants, an efficiency of 26 % can be within reach using engines, whereas small steam turbine plants, using a boiler or using a close-coupled gasification-boiler combination would have difficulty in meeting this criterion unless some element of useful heat generation is included.

The directive also defines R3, "Recycling/reclamation of organic substances which are not used as solvents (including composting and other biological transformation processes). In a footnote it is stated that includes gasification and pyrolysis using the components as chemicals. However, this is not associated with any criteria to define the requirements to become an R3 operation.

There is also some ancillary legislation relating to the WFD. The European Waste Catalogue (EWC)<sup>126</sup> and Hazardous Waste List<sup>127</sup>, in 1994 established coded listings of all wastes to be used for classification and reporting. These were later merged in 2002 into Commission Decision 2000/532/EC and has since undergone a series of further amendments. A new version of this list, Commission Decision (EU) No 2014/955/EU came into force in 2015. Also, Commission Regulation (EU) No 1357/2014 replaced Annex III of the directive where characteristics of hazardous wastes are defined.

A Waste Package was provisionally agreed between the EP, the Council and the Commission in agreed in late 2017 and endorsed by the EU ambassadors in early 2018<sup>128</sup>. This provisional WFD amends six pieces of legislation:

- Waste Framework Directive (considered the umbrella legislative act of the package)
- Packaging waste directive
- Landfill directive
- Directives on electrical and electronic waste
- Directives on end-of-life vehicles
- Directives on batteries and accumulators and waste batteries and accumulators.

<sup>126</sup> Commission Decision 94/3/EC

<sup>127</sup> Council Decision 94/904/EC

<sup>128</sup> <http://www.consilium.europa.eu/en/press/press-releases/2018/02/23/eu-ambassadors-approve-new-rules-on-waste-management-and-recycling/>

The waste package aims at increasing recycling of waste and contribute to the creation of a circular economy as well as to improve the way waste is managed and encourage the re-use of valuable material embedded in waste. It establishes legally binding targets for waste recycling and the reduction of landfilling with fixed deadlines. Member states shall endeavour to ensure that as of 2030, all waste suitable for recycling or other recovery, in particular in municipal waste, shall not be accepted in a landfill. The only exception concerns waste for which landfilling delivers the best environmental outcome.

In addition, member states will ensure that by 2035 the amount of municipal waste landfilled is reduced to 10% or less of the total amount of municipal waste generated. These targets will increase the share of municipal waste and packaging waste which is recycled, with specific targets for the recycling of materials used in packaging. The Member States agreed to the following targets for the preparing for reuse and recycling of municipal waste: by 2025 55 %; by 2030 60 %; by 2035 65 %. Furthermore, the Member States will have to ensure that bio-waste is either collected separately or recycled at source (e.g. home composting) by 2023 and arrange separate collection for textiles and for hazardous waste from households in 2025. This is in addition to the separate collection which already exists for paper and cardboard, glass, metals and plastic. For these recyclables, more ambitious recycling targets are defined for 2025 and 2030.

The package also establishes minimum requirements for extended producer responsibility schemes. Producers under these schemes are responsible for the collection of used goods, sorting and treatment for their recycling. Producers will be required to pay a financial contribution for that purpose calculated on the basis of the treatment costs.

#### **ETS directive 2003/87/EC Consolidated with revisions<sup>97, 129</sup>.**

The Emission Trading system for the EU defines a cap and trade system that was introduced in 2005. The total number of emission allowances in the system is pre-defined, and each emitter will have to provide the number of emission certificates that relates to their annually reported emissions, by a combination of free allowances, saved allowances from previous years or allowances bought in auctions or on the market. Those not fulfilling this obligation have to pay a fine for the missing allowances. There is a European Union Registry for Emission Allowances to keep track of the owner and number of allowances, with an authority in each country that administrates the system on the national level. Based on historic production data provided by the industries, the distribution of free emission allowances is made by assigned national government bodies in NAPs (national allocation plans) and these authorities are also receiving the certified, annual reports of the industries. Since November 2014, the Union registry also implements the rules related to the Effort Sharing Decision establishing binding annual greenhouse gas emission targets for the Member States for the period 2013–2020. The Effort Sharing Decision concerns emissions from sectors not included in the EU ETS, such as transport (except aviation outside the EU and international maritime shipping), buildings, agriculture and waste.

The ETS directive covers all combustion installations above an aggregated value of 20 MW thermal and many other industries (oil refineries, coke ovens, iron and steel plants and factories making cement, glass, lime, bricks, ceramics, pulp, paper and board), once the capacity goes above a threshold limit of typically 20-50 ton/h. It also includes waste co-incineration but not waste incinerators<sup>130</sup>, unless these are integrated into an industry. Such installations are obliged to have a CO<sub>2</sub> emission permit. As of 2012, aviation has also been included in the EU ETS for flights within the EU.

<sup>129</sup> [http://ec.europa.eu/clima/policies/ets/index\\_en.htm](http://ec.europa.eu/clima/policies/ets/index_en.htm)

<sup>130</sup> Differences in the interpretation what constitutes co-incineration between Member States has effectively led to differences in the coverage of the EU ETS between Member States. In Sweden, however, all waste incinerators were classified as co-incinerators by Naturvårdsverket (Swedish EPA) and thus are included.

Although originally only covering CO<sub>2</sub> from 2013, the scope of the ETS was extended to also include other sectors and greenhouse gases. CO<sub>2</sub> emissions from petrochemicals, ammonia and aluminium were included, as were N<sub>2</sub>O emissions from nitric, adipic and glycolic acid production and perfluorocarbons from the aluminium sector as well as the capture, transport and geological storage of all greenhouse gas emissions were also included. In total 11 000 installations are included, and it also covers Iceland, Liechtenstein and Norway.

In the third ETS trading period, 2013-2020, the system covers in total some 40 % of the greenhouse gas emissions in the EC. The power sector essentially obtains emission rights by auctioning or buying them on the market as of 2012. Industries outside of the power industry and some other sectors with specific competition issues with non-EU industry, are receiving free allocation of up to 80 % of the emission allowances, this value being related to an established benchmarking value that is established based on the production characteristics of the 10 % best performing installations (in terms of GHG emissions per unit output) within each industry. The remaining allowances have to be bought or emission reduction measures need to be adopted. Furthermore, the free allowances obtained are also reduced by 3% per year. This reduction is intended to reduce overall emissions by the target set for the third period, 1.7 % per year, but also to have a phase-out of free allowances, such that by 2027, the industry will only receive 30 % of the benchmark value as free allowances.

It is noteworthy that installations that are solely using biomass, or waste incinerators to produce power or energy are not included, and that when the threshold limit for aggregate units has been exceeded, any incineration installation using municipal waste or hazardous waste is not included in the aggregation, i.e. the GHG emissions from waste incinerators owned by that legal entity are under such circumstances not included. However, if the incinerator is integrated in an industrial facility that uses the power and heat, the fossil part of the emissions from waste are included in the emissions. This means that, since free allowances are distributed relative to the benchmark production for an industry, the emissions reported are reduced relative to the use of fossil fuels, and the allowances received for free will cover a larger fraction of the total allowances required.

For the fourth trading period (2021-2030) an agreement was reached in late 2017<sup>131</sup> and formalised in 2018<sup>97</sup>. To achieve the at least 40% CO<sub>2</sub> reduction EU target in 2030, the sectors covered by the ETS have to reduce their emissions by 43% compared to 2005. Therefore, the overall number of emission allowances will decline at an annual rate of 2.2% from 2021 onwards, compared to 1.74% currently; this difference accumulates to 556 million tonnes over the decade. Of the total number of allowances, 43 % will be set aside as free allowances, new entrants and other purposes while 57 % of the allowances will be auctioned. For ordinary industries (not belonging to the 50 industrial sectors where carbon leakage, i.e. relocation of EU industrial production to non-EU countries, can occur and which therefore receive free allowances to maintain competitiveness), 30 % of the benchmark allowances will be obtained for free up to 2026, when it will be linearly decreased to 0 % 2030. The benchmark will be decreased, depending on the industry by 0.2-1.6 % per year, and the benchmarks will be updated relative to the 2008 values to account for technical developments. Some 50 industrial sectors where carbon leakage, i.e. relocation of EU industrial production to non-EU countries, will receive a higher share of free allowances.

To avoid the issues of oversupply of allowances that has been a problem in phase 3, a Market Stability Reserve (MRS) will be implemented as of 2019.

There will also be a modernization fund, directed to the 10 poorest EU countries for upgrading the

---

<sup>131</sup> Grand compromise on ETS reform set to tighten market. Thomson Reuters, 10 November 2017

power generation and supply system, based on 2 % of the auctioning revenues, and an Innovation Fund, based on the sales of 400 + 50 million allowances plus any surplus from the second call of the NER 300 program that will finance support to innovation to decarbonize energy-intensive industries in addition to the innovative energy technologies and CCS covered in the NER300 program.

**Renewable Energy Directive RED (2009/28/EC)** introduced as a part of the 2020 energy and climate package in the EU sets a target for 10 % RE fuels in transport (RE-T) in the member states 2020. In the context of the directive "biofuels" means liquid or gaseous fuel for transport produced from biomass and were "biomass" also include the biodegradable fraction of industrial and municipal waste. Biofuels are also subject to another criterion to be counted towards the RE-T target, that GHG saving shall be at least 35 %, from 2017, at least 50 % and from 2018 at least 60 % in installations in which production started after 1 January 2017. Wastes are included in the group of materials that have zero GHG starting value up to the collection point. Biofuels made from the biodegradable fraction of industrial and municipal waste counts for double its energy content towards the RE-T target.

Following the debate on food and fodder vs. biofuels and other **Indirect land use Change (iLUC directive) (2015/1513/EU)** amended the RED directive in order to mitigate some of the perceived risk with an increased use of biofuels. The definition of waste was referred to the WFD (Directive 2008/98/EC) and Annex IX A and B was introduced listing waste and residue feedstocks for "advanced biofuels" that are eligible for double-counting of their energy content towards the 2020 target and also sets at target of 0.5 % in 2020 for these fuels. This listing includes:

- Biomass fraction of mixed municipal waste, but not separated household waste subject to recycling targets in 2008/98/EC.
- Bio-waste as defined in 2008/98/EC from private households, subject to separate collection as defined in that Directive.
- Biomass fraction of industrial waste not fit for use in the food or feed chain, including material from retail and wholesale and the agro-food and fish and aquaculture industry, excl. feedstocks listed in part B of this Annex.

The directive also states that when setting policies for the promotion of fuels from Annex IX feedstocks, Member States shall have due regard to the waste hierarchy as established in the WFD, including life-cycle thinking on the impacts of the generation and management of different waste streams.

**In the RED II directive**<sup>98</sup>, as agreed June, among other things, defines the targets for RE-T in the period 2021 to 2030. The waste hierarchy and circular economy principles are stressed even further than in the iLUC directive, and replacement effects are also discussed but not causing limitations.

It sets a target for RE-T of 14 % and also a target of 3.5 % (double-counted) for advanced biofuels (Annex IXA feedstocks)2030 And a trajectory for the period 2021-2030. The waste definition remains as in the iLUC directive and wastes are part of Annex IXA and can be double-counted. GHG emissions savings criteria at least 65 % for biofuels from 2021.

It also introduces 'recycled carbon fuels', liquid and gaseous fuels that are produced from liquid or solid waste streams of non-renewable origin which are not suited for material recovery as per the WFD. Member states may or may not include these (from e.g. the fossil fraction of MSW) in the national targets. Since the fossil part of mixed wastes was not advanced biofuels, this recognition of recycled carbons fuels and the possibility to include these in the RE-T target is positive from the perspective of biofuels, as this may be a possibility to valorise also the fossil fraction beyond being a mere fossil fuel.

This directive also introduces GHG saving criteria biomass power and CHP plants 70 % for electricity, heating and cooling production from biomass fuels in installations starting 2021 and 80 % for installations starting operation after 2026. However, this does not apply to waste incineration.

**Medium Combustion Plant (MCP) Directive (EU) 2015/2193** covers combustion units in the range of 1-20 MW thermal using gaseous, liquid or solid fuels. It gives LEVs for such installations, see Appendix 2, Tables A2.3 and A2.4.

#### 4.4. POLICIES IN JAPAN

The regulation<sup>31, 132</sup> in the waste area in Japan began with the Waste Cleaning Act/Sewage Disposal Law in 1900, as in many other nations triggered by health concerns. The act made the municipalities responsible for the waste management and recommended that waste should be incinerated, if possible. But waste incineration facilities were not common, so waste materials were burned in the open.

After WWII, due to a combination of population growth and rapid urbanization, waste generation increased while the collection and disposal of wastes were inadequate. As a consequence, the earlier law was replaced by the Public Cleansing Law in 1954, which strengthened the role of the municipalities. Municipal mayors were in charge of the municipal waste management but could also order proper disposal of other wastes. In practice, however, (industrial) waste generators typically did this with little oversight from the local authorities. The law also gave the national authorities and the prefectures a role of giving the municipalities financial and technical support<sup>133</sup>. Furthermore, in the Act on Emergency Measures concerning the Development of Living Environment Facilities in 1963, the government formulated the Five-Year Plan for the Development of Living Environment Facilities in order to establish policies for the development of adequate and more economic waste collection and logistic systems as well as for the development of waste treatment facilities, including incineration facilities. Industrial wastes were also treated together with MSW for lack of any other means. The responsibility of the municipalities resulted in numerous (thousands) small incinerators.

The population development continued in the 1960's and 1970's and both the industrial production and the economy grew rapidly, which in combination with urban and infrastructural developments, social changes as well as changes in consumption patterns, caused further increases in waste generation and in pollution to air and water, which was seen as serious problem in many locations by both the local authorities and the citizens. Scandals involving poisoning-induced health issues in certain locations due to heavy metal containing waste water released from industries and illegal dumping further increased the pressure on politicians<sup>134</sup>. The municipalities also had increased problems with the increasing waste quantities, and in particular the construction and industrial wastes.

To prevent pollution, the Basic Law for Environmental Pollution Control came into force in 1967 and clarified the responsibilities of the government, the local authorities, the industries releasing pollutants and the citizens. The increasing pressure from the population regarding environmental issues, resulted in that the Japanese bicameral parliament, Kokkai, (referred to as the "National Diet" in English), passed fourteen anti-pollution laws in one session in 1970 ("the pollution Diet"), including a thoroughly revised Waste Management and Public Cleansing Act (Waste Management Act) whereby different types of wastes were classified.

<sup>132</sup> The Japanese industrial waste experience: Lessons for rapidly industrializing countries. Yuko Sakita, et al. UNEP 2013

<sup>133</sup> Somewhat simplified, Japan was in 2014 administratively divided into 47 prefectures (or equivalent) and the prefectures are further divided into 1718 municipalities (or equivalent).

<sup>134</sup> The Evolution of Official Lessons: The Japanese Experience of the "Big Four" Pollution Diseases through the Lens of International Aid. Oscar A. Gómez Salgado Journal of Alternative Perspectives in the Social Sciences (2008) Vol 1, No 1, 81-100

The Air Pollution Control Act (1968) and the Water Pollution Control Act (1970) codified limiting emission values for particulates, acid gases, heavy metals and water pollutants, respectively. The Environment Agency was instituted in 1971 to create a centralized system for environmental administration to implement pollution-related laws. Furthermore, the government established standards for municipal waste management facilities in 1971, which were associated with a financial support system for new installations complying with these regulations. In 1973, the regulation for the Waste Management Act established assessment standards for hazardous waste. Another regulation in 1977 established construction and maintenance standards for three types of final landfill sites for industrial waste: closed landfills, controlled landfills, and open landfills.

Whereas the legislation of the 1970's had a good result in the area of pollution control, the amount of wastes generated still increased throughout the 1980's and 1990's, and the development in general and the increasing wealth resulted in new types of wastes such as electronics, scrapped cars, home appliances, plastic packaging and containers, etc. This caused a rapid filling up of existing landfills and increasing difficulties in maintaining the operational standards. Increased dumping and use of illegal landfills led to scandals and public spending to remove waste and to restore the areas damaged. The shortage of landfills also caused more or less severe controversies, on the one hand between municipalities, and on the other hand, between the public and municipalities and other authorities, regarding establishment of landfills and incinerators in one or the other municipality, or regarding treatment of pre-treated wastes transported from another municipality (untreated wastes is not allowed be transported outside the municipality).

To improve the situation, the 1970 law was revised in both 1991 and 1997 regarding licensing of treatment facilities and in the stricter controls of industrial and special wastes, while raising the penalties for non-compliance. The 1991 amendment included an additional purpose of the law, to reduce the amount of waste generated and also recycling waste.

In the 1990s, it became more apparent that more fundamental structural changes in environmental policies were required to cope with the domestic waste problem. In addition, global environmental issues were increasingly present in the international agenda, following the various UN conferences and other initiatives from 1972 and onwards. The Act on the Promotion of Effective Utilization of Resources, 1991, established that environmental considerations should influence product design and manufacturing as well as defining systems for independent waste collection and recycling by business operators. The act also was basis for giving support to the development of recycling technologies. In addition, the government established a variety of recycling acts to further promote waste recycling, such as the Law for Promotion of Selective Collection and Recycling of Containers and Packaging (1995), or the Law for the Recycling of Specified Kinds of Home Appliances (1998).

This restructuring led to the 1993 Basic Environment Act<sup>135</sup> that states the basic principles of environment conservation, the responsibilities of various entities, fundamental policies for environment conservation, emphasis on cooperation between various parties in society-wide efforts for the protection of the global environment. The act emphasizes the four key concepts of "material cycles", "symbiosis", "participation" and "international efforts". Concretely, it repealed the 1968 Air Pollution Control Act, and gave new LEVs for some of the main pollutants and it is still, by regulations and bylaws the main element of air pollution control. A major revision of the waste incinerator air pollution regulations was on-going in 2014<sup>136</sup>.

A plan for the modernization of incinerators was also carried out complemented by a financial support scheme initiated in 1996 for constructing new large-scale incinerators. Furthermore, to

---

<sup>135</sup> <https://www.env.go.jp/en/laws/policy/basic/>

<sup>136</sup> [http://www.ctyi.net/news\\_view\\_84\\_107.html](http://www.ctyi.net/news_view_84_107.html)

prevent leaching and dioxin emissions in landfills, a guideline prescribing ash melting was issued in 1996, and this was made a condition for accessing the financial support in 1998<sup>137</sup>. This had a profound effect on the technology used, and waste gasification was becoming increasingly common. However, in 2003, a new guideline acknowledged that exceptions to ash melting could be accepted and by 2005 the compulsory use of ash melting was lifted.

The Basic Environment Act also established the Basic Environment Plan as a policy tool containing concepts and long-term (mid 21th century) objectives for continued work, the policies to be implemented in the earlier part of the century for achieving these objectives. The plan is updated approximately every five years and the 4th plan is now in force. The progress of the Basic Environment Plan is monitored annually by the Central Environment Council that reports to the national government. In the First Basic Environment Plan in 1994, the four long-term objectives were:

- Environmentally Sound Material Cycle
- Harmonious Coexistence
- Participation
- International Efforts

In 1993 Japan ratified the Basel convention and enacted the Law for the Control of Export, Import and Others of Specified Hazardous Wastes and Other Wastes to strictly control export and import of hazardous wastes specified in the Convention.

In the late 1990s, dioxin emissions from waste incineration facilities became a major issue. In 1999, the Law Concerning Special Measures against Dioxins was enacted. This led to the introduction of comprehensive measures, including tightened regulations on flue gases from incineration plants, government support systems for technological development by business operators, and support for the improvement of incineration plants by local governments. The actions were successful, and the dioxin emissions were reduced by 98 % from the 5 kg emitted in 1997 within less than a decade. The ministerial council responsible for the dioxin issue also looked more broadly to the waste disposal and recycling and recommended reducing the amount of waste generated, promoting recycling, and setting waste reduction targets. A policy agreement was reached that resulted in the Basic Act on Establishing a Sound Material-Cycle Society in 2000, which legally defined the Japanese version of the waste hierarchy, the "3 Rs", reduce, re-use, recycle (and where incineration, even if integrating energy recovery, is seen as a disposal method, albeit better than landfilling), Figure 22. Following on this policy and previous recycling laws, several new recycling laws were enacted, the Law on Recycling of Construction-Related Materials, the Law for Promotion of Recycling and Related Activities for the Treatment of Cyclical Food Resources in 2000, and later also the Law for the Recycling of End-of-life Vehicles in 2002 (defining that, in addition to a 80 % recycling, also shredder residues should be recycled to 70 %, i.e. 6 % to disposal, in 2015, and where the industry already in 2015 achieved over 90 % recycling of this material) and the Law on Promotion of Recycling of Small Waste Electrical and Electronic Equipment in 2012. In other areas, the Law Concerning the Promotion of Procurement of Eco-Friendly Goods and Services by the State and Other Entities was also adopted in 2000 while revisions were made to the Waste Management Law and the Law for the Promotion of Effective Utilization of Resources.

---

<sup>137</sup> Latest Results of Bottom Ash Handling in Japan Nobuhiro Tanigaki. 16/4/2015 Japan Environmental Facilities Manufacturers Association (JEFMA) /NIPPON STEEL & SUMIKIN ENGINEERING CO., LTD.



**Figure 22 The Japanese 3R logotype<sup>31</sup>**

Furthermore, in 2001 the Ministry of Environment, MoE, was established as a separate ministry by merger of other organizations and ministerial departments with responsibilities in the area.

The government also developed the Fundamental Plan for Establishing a Sound Material-Cycle Society in 2003 as a policy support to the act, and the plan was updated in 2008 where low-carbon measures were more highly profiled. This also led to support measures from 2010 to maintain and upgrade incinerator in service to avoid landfills and to increase the efficiency in new installations by setting a target for the installed capacity of 2.5 GW in 2012; however only 1.7 GW was reached<sup>138</sup>. A promotion program was initiated in 2010, so that a performance rate reflecting an energy efficiency was introduced to be eligible for the general investment subsidy of 33 % and for the high energy efficiency subsidy of 50 %, respectively<sup>139</sup>. Also, the direct use of heat, and CHP is promoted, as there are still many incinerators without energy recovery.

The third, updated plan was established in 2013, i.e. occurring after the earthquake and nuclear accidents in 2011. It is noted in the plan that these events have generated severe strains on the society to manage the debris and wastes generated by these events. The third plan focuses on reducing and reusing waste, which tend to lag behind initiatives for recycling and also international activities. The plans create material flow diagrams representing material entrances, circulation and exits, as well as setting goals regarding resource productivity, the recycling rate, waste generation and the final disposal (reduce per capita household waste generation by 25 % in 2020, relative to 2000, final disposal of 17 million ton in 2020, etc.). Several of these goals for 2015, including final disposal quantities were reached even before this year.

In the area of climate policies<sup>140</sup>, already in 1990, the Japanese government developed the Action Program to Arrest Global Warming to achieve the 1990 levels level of CO<sub>2</sub> per capita emissions by 2020. Japan was one of the signatories of the Kyoto protocol agreement in 1997, and in Japan the Act on the Promotion of Global Warming Countermeasures was enacted in 1998. In 2005, a Kyoto Protocol Target Achievement Plan was made to identify the policy interventions needed to meet the Japanese commitments, which were set to a reduction of 6 % CO<sub>2</sub> emissions relative to 1990. One action was an amendment in 2005 of the 1998 law to include an RPS modality, e.g. requiring a certain fraction of renewable electricity in the overall electric energy balance, JVETS (Japanese Voluntary Emission Trading System), where voluntary participants would themselves set a cap on their own future emissions as basis for issuing tradable emission certificates (based on 1 ton of CO<sub>2eq</sub>) to be counted against actual emission performance. The scope of the JVETS covered CO<sub>2</sub> emissions from industrial processes (production and energy consumption), offices (energy consumption) and waste management (waste incineration, waste combustion, and waste recycling). In 2008, further amendments were applied to transform the JVETS into the Experimental Integrated

<sup>138</sup> Waste to Energy – Heat recovery from waste 1. Hitachi Zosen Corporation. February 25, 2015

<sup>139</sup> Environmental Economic Growth Japanese Initiatives. T FUJITSUKA. The Ministry of the Environment Japan, 25 November 2011

<sup>140</sup> Japan. The World's Carbon Markets: A Case Study Guide to Emissions Trading. May 2015 (this document also holds references to the legal enactments discussed)



ETS, which was a mean to integrate various types of emission reductions into one ETS system (CDM, use of renewable energy, voluntary emission reductions, energy efficiency measures) via the introduction of J-VER, Japanese Verified Emissions Certificate system into the law, as a mean to develop a permanent and compulsory system. Since 2009, a grant of 33 % of investments in GHG emission reductions became available (repayable for underperforming relative to the defined target).

Further changes to the law were made in 2010. These included a mid-term target to reduce GHG emissions with 25 % by 2020, compared to 1990 levels, a long-term target to reduce GHG emissions to 80% below 1990 levels by 2050, a target for renewable energy to 10 % of the primary energy by 2020 to be supported by a feed-in tariff program, a commitment to establish a domestic emission trading system (ETS), and the introduction of a carbon tax. The carbon tax was levied on coal, LPG, natural gas, crude and other oil products from 2012 and has gradually been raised up to 2016 to achieve a consistent level of 289 JPY/ton of CO<sub>2</sub> (2.5 €/ton) for all fuels<sup>141</sup>. Furthermore, based on the amended act, Guidelines for Controlling Greenhouse Gas Emissions<sup>142</sup> have been formulated for some industrial sectors, including waste incineration<sup>143</sup>, to encourage business operators to voluntarily implement environmentally-friendly business actions on a voluntary basis. The guidelines, which at present have no impact for compliance or non-compliance, can possibly be the starting point for the development for a BAT regulation.

However, Japan did not sign-up for a second commitment period under the Kyoto protocol in 2010. The 2011 earthquake and the Fukushima nuclear power plant accident made Japan reduce its 6 % target for the first commitment period from 6 % to 3.8 % in 2013. Also, the ETS system was abandoned in 2012. At the end, the system had grown to almost 400 industrial participants who had managed to reduce emissions by over 2 million tons since 2006, exceeding the self-imposed consolidated target of 1.2 million tons made by the participants. The emission certificates that had initially traded for over 1 200 JPY were now reduced to around 200 JPY (2€). Other complementing measures were introduced in 2013 such as the Joint Crediting Mechanism (JCM, *aka* Bilateral Offset Crediting Mechanism (BOCM)) and the Japan greenhouse gas emission reduction certification scheme (J-Credit Scheme).

In addition to the climate change policies there are also supporting policies. The Rational Use of Energy Act was introduced after the oil crisis in 1979 and was amended in 2012. The amendment on the one hand focused in the short-term on reducing the peaks in electric consumption after the 2011 events, but on the other hand had a more long-term goal by also targeting the household appliances and home electronic devices that consume some 70 % of the household electricity, vehicle efficiency and set criteria for energy savings on other energy- or transport-consuming products and goods.

In the area of renewable energy, the Act on the Promotion of New Energy Usage of 1997 provided financial support and loan guarantees to private companies and financial support to local authorities when establishing new energy projects. As of 2003, this support was replaced by the RPS system, where utilities were obliged to buy a certain quota of renewable electricity at a negotiated price. The Act on Special Measures concerning the Procurement of Renewable Electric Energy by Operators of Electric Utilities (Renewable Energy Act)<sup>144</sup> came into force in 2012. The law makes it a requirement

---

<sup>141</sup> Details on the Carbon Tax (Tax for Climate Change Mitigation). Ministry of the Environment 2012

<sup>142</sup> Japan's Climate Change Policies. Ministry of the Environment, March 18, 2014.

<sup>143</sup> JEFMA, Japan Environmental Facilities Manufacturers Association. [www.jefma.or.jp/english](http://www.jefma.or.jp/english). The guidelines published have the form  $\text{kgCO}_2/\text{ton waste incinerated} = -240 \cdot \log(\text{ton/day waste incinerated} + A)$ . A varies between new and old plants and technologies. New plants have A=500, new gasification ash melting plants A=560, incinerators with external ash melting A=600. This formula is however difficult to interpret as an absolute emission, as for large installations above 100 ton/day the emission would become negative, and waste would generate the same CO<sub>2</sub> emission based on its fossil carbon content, irrespective of size and age.

<sup>144</sup> Feed-in Tariff Scheme for Renewable Energy. Ministry of Economy Trade and Industry. 2015

for electric utilities to give grid access to, and to purchase all electricity generated from renewable energy installations (solar, onshore wind, geothermal, biomass, waste and small hydropower) at a fixed price (Feed-in Tariff) relating to the technology and capacity of the installation. To compensate for the cost difference relative to non-renewable power, the utilities can transfer this cost as a pro-rata surcharge when billing its customers (with some exemptions). The scheme has led to a rapid increase in the projects adopted<sup>145</sup>, in particular for non-residential PV installations that have constituted 2/3 of the RE capacity added since 2012, 80 GW. However, since there is no end date when an installation has to deliver to the grid, there has been a run to have a good FIT price contract, but only less than a third of the PV installations have materialized, as costs for the installations are falling and a late entry may involve a less costly and better performing system. The surcharge cost has now also risen to 9 % on the electric bill which has aroused protest from industry (who only pays 20 % of the surcharge), businesses and consumers. As of 2017, the non-residential PV installations will be contracted via an auctioning scheme. Wind and residential PV will receive a FIT, but which is reduced over time. Biomass and wastes will benefit from having the FIT announced 2-5 years in advance and not be subject to a time-reduction. Furthermore, a project lead time will be applicable in future decision and also a follow up on the compliance with other conditions of the FIT system.

In addition to the policies of the government, also other stakeholders are active. Keidanren<sup>146</sup>, the Japan Business Federation is an organization comprised of 1 300 companies, 121 manufacturing industries associations, service industries and other major industries and 47 regional economic organizations. In the environmental and climate areas, the organization has assumed voluntary commitments in e.g. reducing industrial wastes, energy use and intensity as well as carbon footprint and carbon intensity through the Keidanren Voluntary Action Plan on the Environment.

#### 4.4.1. Regulations

The main Japanese regulations covering solid wastes and thermal treatment are highlighted below.

##### **Basic Act for Environmental Pollution Control 1967.**

It defined the protection of the health of the people and the living environment as the responsibility of the government at the national level, while local governments were responsible for the pollution prevention within their jurisdiction with due consideration for the local natural and social conditions. Residents (physical and legal) should cooperate with the local authorities to implement pollution control measures. It also made business operators responsible for the prevention of pollution by the proper treatment of gases, wastewater, and waste.

##### **Waste Management and Public Cleansing Law (Waste Management Law) 1970**

It legally defines waste. Waste is furthermore classified as "industrial waste" (further divided into 20 sub-categories) or "municipal solid waste", and "specially controlled industrial waste" or "specially controlled municipal solid wastes", the latter being hazardous in nature. There are separate regulations and systems stipulated for the four categories in order to ensure appropriate treatment for each.

It states the Polluter Pays Principle (PPP) for the waste management and introduced standards for the collection, transport and disposal of industrial waste as well as introduced a licensing system for industrial waste disposers. Waste other than industrial waste and specially controlled wastes are defined as "municipal solid waste" which by law must be treated by municipal governments. The generator of "commercial municipal solid waste" is still responsible for its treatment, but it is

---

<sup>145</sup> Changes to Japan's Existing Renewable Energy Feed-in-Tariff System. White & Case. June 8 2016.  
<http://www.whitecase.com/publications/alert/changes-japans-existing-renewable-energy-feed-tariff-system>

<sup>146</sup> <http://www.keidanren.or.jp/en/>

accepted in the municipal system against a gate fee. The entity generating "industrial waste" has the legal responsibility for treating it, either in-house or by outsourcing it to a licensed waste treatment contractor.

### **1993 Basic Environment Act<sup>147</sup>**

The first chapter sets out three basic principles for environmental conservation; for the sake of present and future generations, that a society can be formulated where the environment is conserved, and sustainable development is ensured, promotion of the global environmental conservation in cooperation with other countries.

The second chapter gives a list of basic policies for environmental conservation considerations in policy formulation including the establishment of the Basic Environment Plan to give the long-term policy goals, use of environmental impact assessments when developing projects, economic measures to encourage environmental activities, policy and measures to deal with global environmental problems as well as the promotion of education, science and technology, of environmental activities by corporations, citizens and NGOs. It requires businesses to ensure proper disposal of waste, to make efforts to reduce the environmental burden from use and post-use of products and to facilitate recycling.

It also defines the responsibilities of each sector of the society (national and local governments, corporations, and citizens) in living up to these principles. The third chapter stipulates that the policies listed in chapter two should be formulated starting with the central government bodies and going down to the regional and local level.

A bylaw of this act also prescribes more stringent air pollution measures than in the previous Air Pollution Act. The LEVs in use in Japan are summarized in Appendix 2 Tables A2.5 and A2.6. However, a major revision of the waste incinerator air pollution regulations was on-going in 2014<sup>136</sup>, so the data may soon be changed.

A plan for the modernization of incinerators initiated in 1996, complemented by a financial support scheme for constructing new incinerators<sup>148</sup> above 100 ton/day. The support had the local authorities as beneficiaries and provided these a support of 33-50 % of the cost for the construction of modern incinerators. In addition to this direct subsidy, there are also means of bond financing assisted by tax allocations etc., that significantly reduce the financing cost of waste incinerators for the municipalities<sup>149</sup>.

Furthermore, to prevent leaching and dioxin in landfills, a guideline prescribing ash melting was issued by the Ministry of Welfare and Health in 1996, and an additional guideline made this a condition for accessing the financial support in 1998<sup>137, 150</sup>. This had a profound effect on the technology used, and waste gasification was becoming increasingly common. However, in 2003, a new guideline acknowledges that exceptions to ash melting could be accepted and by 2005, when also changing the grant system to a subsidy system, the compulsory use of ash melting was lifted. However, to receive the 50 % subsidy level, it could still be a requirement. The municipalities can

---

<sup>147</sup> <https://www.env.go.jp/en/laws/policy/basic/index.html>

<sup>148</sup> Incineration of Municipal Waste and Measures against Dioxin in Japan. Tofu Sanbongi et al. Ministry of Welfare and Health NAWTEC 2005.

[https://www.google.se/url?sa=t&rct=j&q=&esrc=s&source=web&cd=1&cad=rja&uact=8&ved=0ahUKEwjY6MjT\\_u30AhWMDywkHcV8Ca8QFggoMAA&url=http%3A%2F%2Fwww.seas.columbia.edu%2Fearth%2Fwert%2Fsofos%2Fnewtec%2Fnewtec05%2Fnewtec05-17.pdf&usg=AFQjCNFAOxXh3jt4p-IPB-fxjI64DYgsiQ](https://www.google.se/url?sa=t&rct=j&q=&esrc=s&source=web&cd=1&cad=rja&uact=8&ved=0ahUKEwjY6MjT_u30AhWMDywkHcV8Ca8QFggoMAA&url=http%3A%2F%2Fwww.seas.columbia.edu%2Fearth%2Fwert%2Fsofos%2Fnewtec%2Fnewtec05%2Fnewtec05-17.pdf&usg=AFQjCNFAOxXh3jt4p-IPB-fxjI64DYgsiQ)

<sup>149</sup> Waste Management for Smart City: Waste-to-Energy Practices in Japan and the Efforts to Implement WtE Projects in Asian Countries. Shiko Hayashi. International Conference Renewable Energy Asia 2017: Moving Towards ASEAN's Smart Cities. June 7th, 2017

<sup>150</sup> Bottom ash from incinerators is seen as a waste in Japan, whereby it cannot be re-used, nor be disposed of as "general waste" unless leaching tests and dioxin analysis results are acceptable. Bottom ash not passing such criteria and fly ash are seen as "specially controlled wastes" and require a treatment prior to re-use.





however choose a less costly solution, if the disposal of the ash fractions can be arranged but will receive less support in this case.

### Basic Act on Establishing a Sound Material-Cycle Society

The 2010 amendment of this act included a performance requirement for incinerators to be eligible for the subsidy of a "General energy recovery system" at 33 % of the investment, or of a "High rate energy recovery system" at 50 %, respectively. The performance indicator is dependent on the capacity of the incinerator and is estimated as a notional power efficiency based on the energy in the power and heat produced relative to the energy in the waste incinerated.

### The Act on Special Measures concerning the Procurement of Renewable Electric Energy by Operators of Electric Utilities<sup>144,151, 152</sup>

This law defines a FIT system that was initiated as of 2012, which is operated by METI. The system covers electricity generated from renewable energy installations (solar, onshore wind, geothermal, biomass, waste and hydropower below 30 MW). The FIT for each technology, and capacity when applicable, is based on the cost of generating electricity by the technology, technical life-time and the need to ensure that the return to the investor, in particular in the first three years. Installations that have been approved according to the regulations can then sell the electricity at the FIT price applicable for the installation for a period of from 10 to 20 years. The technologies and the 2014 FIT are shown in Figure 23. (Please note changes proposed for 2017 as discussed above). New power generation from waste receives 18.36 JPY (0.15 €) per kWh produced.

	<b>Solar</b>	<b>10kW or more</b>	<b>Less than 10kW</b>		<b>Wind</b>	<b>20kW or more</b>	<b>Less than 20kW</b>
	Tariff	34.56 JPY (0.29 €)	37 JPY (0.27 €)		Tariff on-/off-shore	23.76/38.88 JPY (0.20/0.33 €)	59.40 JPY (0.50 €)
	Duration	20 years	10 years		Duration	20 years	20 years
	<b>Hydraulic</b>	<b>From 1MW to 30MW</b>	<b>From 200kW to 1MW</b>	<b>Less than 200kW</b>			
	Tariff	25.82 JPY (0.22 €)	31.32 JPY (0.26 €)	36.72 JPY (0.31 €)			
	Duration	20 years	20 years	20 years			
	<b>Geothermal</b>	<b>15MW or more</b>	<b>Less than 15MW</b>				
	Tariff	28.08 JPY (0.24 €)	43.20 JPY (0.36 €)				
	Duration	15 years	15 years				
	<b>Biomass</b>	<b>Methane fermentation gas</b>	<b>Burning timber from forest thinning</b>	<b>Burning other timber</b>	<b>Burning waste</b>	<b>Burning recycled timber</b>	
	Tariff	42.12 JPY (0.36 €)	34.56 JPY (0.29 €)	25.92 JPY (0.25 €)	18.36 JPY (0.15 €)	14.04 JPY (0.12 €)	
	Duration	20 years	20 years	20 years	20 years	20 years	

**Figure 23** 2014 Feed-in Tariffs for Renewable Electricity in Japan (Adapted from<sup>152</sup>, data from<sup>151</sup>).

<sup>151</sup> Renewable Energy Projections Through 2030 and Strategy. Takao Ikeda, November 12th, 2014 APEC EGNRET43, Chiang Mai, Thailand

<sup>152</sup> FIT in Japan. Kazuhiro Ueta, Kyoto University, 7 January 2015, IGES-TERI Policy Research Workshop, India Habitat Centre On the road to Paris: The readiness of key countries for COP21 and beyond

## 4.5. POLICY IN THE USA

The policy section focuses on federal policies and legislation. It should be noted that the history of state legislation and its implementation can differ widely between the states, and where states have due to the local circumstances been introducing regulations earlier or later, or with a broader scope than the federal government. However, detailing the development in each state goes beyond the scope of this section in relation to the main topic of the report.

The early colonial settlers in the new cities in America were using the same methods as they were accustomed to from Europe for disposing of waste, i.e. dumping in the street<sup>153</sup>. In the early United States, initiatives were taken (by e.g. Benjamin Franklin in Pittsburgh, PA) to instead organize dumping outside the cities or in convenient waterways or requiring citizens to burn combustible wastes. After the Civil War, cities grew, and immigration increased so that the waste quantities grew, causing health and sanitation issues in many growing cities. From that period, a similar development was seen in the US as elsewhere, the cities took more and more interest and control of the waste management, motivated by the need to safeguard the health of the public. In the late 19<sup>th</sup> century and early 20<sup>th</sup> century, the major cities in the east had already organized waste collection as part of the public works. However, the wastes collected were still dumped or openly incinerated within what was considered cheap land at a safe distance from the city or dumped at sea or in waterways. The 1899 Refuse Act, a section of the Rivers and Harbors Act, prohibited dumping of refuse into navigable waters; however, it related to the risks and difficulties caused for navigation than on other aspects of waste dumping.

Most states dealt with the waste issue by making it the responsibility of local authorities and by prohibiting waste dumping on public property and littering.

Landfills was for these local authorities the main mean for waste disposal. These were often purposefully set afire. In addition, incinerators came into more widespread use. These were often located in central areas to minimize waste transports and enable heat recovery as mainly steam but also added to the local air pollution. Another practice was to feed wastes to swine, but in the 1950's outbreaks of epizooties caused this to be banned unless the wastes had been cooked before feeding.

In the decades following WWII, the affluence increased, and the composition of solid waste changed. The waste had up to this time contained ash and food residues, but now paper and plastic packaging materials and disposable products were found in the waste, and less ash as gas and oil replaced solid fuels. Also, the waste quantities grew, and waste disposal became an increasingly pressing issue for local communities, while littering became a general problem, in particular along highways and roads.

The population also expanded in this period while many Americans moved from rural areas to the cities. Many of the new city-dwellers came to live in the suburbs where there was yet no organized trash collection. This led to the emergence of private waste contractors that removed wastes. Initially, these were local and had small resources for managing the disposal of the wastes. Gradually the market for these services was consolidated into larger entities that could compete for contracts based on economy of scale, and also finance the investments needed. However, sanitary conditions in smaller towns did not improve as soon as they did in cities. As late as in the mid-1960s, less than half of U.S. towns with populations above 2 500 inhabitants had solid waste disposal programs in addition to dumping the garbage on cheap land with minor considerations for

---

<sup>153</sup> Managing America's Solid Waste. J.A. Phillips. NREL/SR-570-25035. National Renewable Energy Laboratory, 1998

long-term consequences.

However, and similarly to the situation other continents, in the 1960s and 1970s the effects of pollution and littering became more noticeable, and scandals aroused the public awareness on environmental issues. In particular in the 1980s, when compliance with federal and local regulations forced the public sector to invest in new facilities or the revamping of existing treatment units, many communities favoured contracting services to private companies instead of organizing waste collection and disposal as a public operation. In the late 1980s, less than half of the local communities operated waste services as part of the public works, and less than a third conducted it in a dedicated commercial entity.

Due to the particular difficult air pollution problems in the Los Angeles area, California enacted a state air pollution act<sup>154</sup>. During the 1950s, the Congress enacted the Public Health Service Act, which authorized the Surgeon General to collect information and develop in relation to the spread diseases but with an inadequate budget to reach conclusive results.

Also, the Air Pollution Control Act (APCA) of 1955 was the first federal legislation on air pollution and provided funds to the Public Health Service, 3 million \$/year for five years, for research in monitoring and control of air pollution, and it was prolonged for another four years at 5 million \$ in 1959, including a program on health effects vehicle emissions. The act was amended in 1960 and 1962. However, the act did not involve any regulations and control measures, as this was seen as the responsibility of the states<sup>155</sup>.

The Clean Air Act (CAA) in 1963, in the wake of strong public pressures, was the first attempt to actually control air pollution in the USA by allocating 95 million \$ to air pollution control by activities similar as in the APCA. The CAA involved the federal government in inter-state pollution issues and in addition urged the development of state control agencies<sup>153</sup>.

Up to the 1960s, there were not any substantial federal involvement in waste management regulations, but the waste situations and the need for national policies made President Johnson take the initiative that led to the Solid Waste Disposal Act, passed by the Congress as Title 2 of the 1965 amendments to the 1963 Clean Air Act, i.e. in direct relation to the CAA. This introduced environmental protection as a second objective to that of safeguarding public health. It recognized refuse disposal as a national issue, launched a federal research and development program and set up grants to states and municipalities for new disposal programs. The U.S. Public Health Service and the Bureau of Mines were implementing authorities. The Bureau of Solid Waste Management provided funding for states to develop solid waste management plans. At the time, no state had a solid waste agency, and only five states even had employees in the area. By 1975 all 50 states had adopted solid waste regulations<sup>153</sup>.

The Air Quality Act of 1967 enabled the federal government to increase its activities to investigate enforcing interstate air pollution transport, and for the first time, to perform far-reaching ambient monitoring studies, emission inventories and stationary source inspections<sup>153</sup>. The law required publication of Air Quality Criteria (AQC) reports. The country was divided into Air Quality Regions, and for the first time in this area included obligations on the states.

National Environmental Policy Act (NEPA) of 1969 founded the Council of Environmental Quality, with responsibility for national policy on solid waste generation and disposal. It also introduced a

---

<sup>154</sup> Clean Air Act Implementation in Houston: An Historical Perspective 1970-2005. C. D. Forswall and K. E. Higgins. Environmental and Energy Systems Institute. Rice University. February 2005

<sup>155</sup> Air Pollution Control Technology Handbook. K. B. Schnelle, Jr., C. A. Brown. CRC Press, 19 Apr. 2016

requirement for environmental assessments and environmental impact statements as part of the planning of federal projects.

In 1970, the federal government enforced stronger regulations on waste management and air pollution. The 1970 amendment to the Clean Air Act gave the federal government broad regulatory powers to protect air quality, defining limiting emission values and clearly indicated that polluting industries would have to close or meet emission standards. This legislation authorized the development of federal and state regulations to limit emissions from both stationary and mobile sources. Furthermore, the federal enforcement authority relative to the states, was substantially expanded.

Incineration was a common disposal method until the 1960s when the Clean Air Act and its amendments gradually forced many polluting incinerators to close. There were about 300 solid waste incinerators in 1968. By about 1975, only some 20-30 newer plants from the 1970s remained which were using similar pollution control technology that was starting to be used on power plants.

The 1970 Resource Recovery Act (RCA) amended the Solid Waste Disposal Act, reaffirmed a federal role in solid waste management, shifted emphasis in the federal program from disposal to recycling, materials recovery, and waste-to-energy conversion and gave federal jurisdiction over hazardous waste. It authorized a federal grant program for the development and implementation of new waste technologies and mandated the creation of guidelines for solid waste collection, transport, separation, recovery, and disposal. The intention was also to improve landfill practices, but without regulatory authority over solid waste management this was not effective, neither did it provide significant funding for the development of better landfilling practices. But on the success side, the federal assistance led to the creation of solid waste management programs in all states by 1975 and three-quarters of the states had also developed resource recovery programs, including plans for developing waste-to-energy facilities.

Also, the Environmental Protection Agency, EPA, was instituted in 1970 to be responsible for executing the environmental laws. EPA was organized from the environmental divisions of the Departments of Agriculture, Interior, and Health, Education and Welfare, as well as from other federal agencies. A major part of the EPA's mission is to prevent, reduce, and control pollution through research, monitoring, regulation, and enforcement. The agency also was responsible for efforts to stop open dumping.

In other environmental areas, new laws were passed with impact on waste management. The Marine Protection Research and Sanctuaries Act 1972 attempted to curtail ocean dumping but with limited success. The Water Pollution Control Act of 1972 had the objective of protecting and restoring the ground and surface waters.

An outfall of the oil crisis was the Energy Reorganization Act of 1974, which mandated the formation of the Nuclear Regulatory Commission and the Energy Research and Development Administration (ERDA), which were merged into the Department of Energy (DOE) in 1977, whose mission is to develop domestic energy resources, including energy recovery from waste, while the Non-Nuclear Research and Development Act from the same year initiates federal research on, among other things, the productive use of waste. DOE had the mission to broaden federal control over energy, including energy from waste. DOE delegated the management of MSW programs to Argonne National Laboratory until 1986, and then to NREL. In its 1991 National Energy Strategy also recognized waste combustion as a source of renewable energy.

Following issues with hazardous wastes in landfills, in 1976 the Resource Conservation and Recovery Act (RCRA) replaced the 1970 RCA. It established a comprehensive federal involvement in

solid waste management that included regulatory authority for the first time. A broad definition of waste, sub-divided into two categories: hazardous and non-hazardous, gave the federal government jurisdiction over almost all waste but retained the responsibility of states for regulating solid waste with one exception, prohibiting interstate movement of waste. The intent of the RCRA legislation was to improve solid waste management by discouraging open dumping and encouraging the development of technologies to recover materials and energy from solid waste and included technical and financial aid to states and municipalities for solid waste management planning.

The law was primarily designed to improve solid waste management practices, but it did not address closed or abandoned dumps. Due to public pressures in the wake of several cases of mismanagement of hazardous wastes, instead the regulation of hazardous waste became the primary concern for the federal government and EPA causing less attention to the other issues intended. Nevertheless, the practice of open dumping was gradually abandoned for managed landfills and energy recovery, starting with the bigger cities and gradually spreading out to more rural areas. In less than a decade, nearly two-thirds of the landfills closed. During the same period, materials and energy recovery were introduced as important solid waste management options.

The act itself does not refer to the waste hierarchy, but the concept has been widely used both in state regulations starting with California in the 1980s as well as in national policy and is also integrated into the EPA guidelines and regulations since the EPA strategy document 1989 Agenda for Action, which endorsed the concept of integrated waste management.

The 1977 Amendments of the CAA primarily concerned provisions for the Prevention of Significant Deterioration (PSD) of air quality in areas attaining the National Ambient Air Quality Standards (NAAQS) and also contained requirements pertaining to sources in non-attainment areas for NAAQS (i.e. an area is a geographic area not meeting one or more of the federal air quality standards). It established major permit review requirements to ensure attainment and maintenance of the NAAQS.

Comprehensive Environmental Response, Compensation, and Liability Act (CERCLA), *aka* Superfund, was enacted in 1980 in response to the discovery, in the late 1970s, of a large number of abandoned, leaking, hazardous waste dumps that were a threat to human health and the environment. The primary objectives of the Superfund program included identification of potential release sites, remedy actions and to identify and potentially responsible parties for such sites who would be liable for the costs for the remedies. The "Super Fund" was established primarily by tax assessments on oil and designated chemicals, and it created a 1.6 billion \$ trust fund to pay for federal response actions. The problem of abandoned hazardous waste sites proved to be extensive. By the Superfund Amendments and Reauthorization Act (SARA) of 1986 the program was prolonged five years, but it also increased the fund to 8.5 billion \$.

In 1984, the RCRA was amended by the Hazardous and Solid Waste Amendments (HSWA), created largely in response to citizen concerns that existing methods of hazardous waste disposal, particularly land disposal, were not safe. The amendments were significant and with differences in the authority of implementation of this amendment relative to the original RCRA.

The Ocean Dumping Ban Act of 1988 made it illegal to dump, or transport for the purpose of dumping, sewage sludge or industrial waste into ocean waters after the end of 1991 unless a permit was obtained from EPA, while the Shore Protection Act from the same year prohibited the transportation of municipal or commercial waste within coastal waters by a vessel without a permit and number or other marking from the federal Department of Transportation, but who must deny a permit if so requested by EPA.

The Pollution Prevention act 1990 made it a national policy that pollution should be prevented and



reduced at the source, and if not feasible recycled if possible and otherwise as a last resort released or disposed of in a safe and environmentally sound manner. The law concluded that the USA annually produces millions of tons of pollution and spends tens of billions of dollars per year controlling this pollution while there are significant opportunities for industry to reduce or prevent pollution at the source through cost-effective changes in production, operation, and raw materials use. The view was that opportunities for source reduction were often not realized because existing regulations, and the industrial resources they require for compliance, focus upon treatment and disposal, rather than source reduction. The EPA was assigned with the task of establishing a source reduction program based on information collection, financial assistance to States, other activities to prevent pollution at the source, promote the use of greener substances, and conserve natural resources.

The Clean Air Act was amended by the 1990 CAAA whereby the authority and responsibility of the federal government was increased. New regulatory programs were authorized for control of acid rain and for the issuance of stationary source operating permits. It expanded the National Emission Standards for Hazardous Air Pollutants (NESHAPs) program for controlling a specified 190 toxic air pollutants. The provisions for attainment and maintenance of NAAQS were modified and expanded. Other revisions included provisions regarding stratospheric ozone protection, increased enforcement authority, and expanded research programs. By amendments in 1996 an even more stringent regulatory program was enacted. The amendments required EPA to regulate emissions from facilities producing 10 short tons or more of any one pollutant in a year or 35 short tons per year of any combination of pollutants. Separate emission guidelines and new source performance standards were issued for waste treatment facilities such as landfills and small and large municipal waste combustors. The basis for the emissions standards reflects the maximum achievable control technology (MACT) meaning that new facilities must control emissions at the level of the best currently available technology. EPA issued final regulations in November 1995 that include limits on specific emissions of a number of pollutants, requirements on emission monitoring, performance standards for pollution control technology, and requirements for training and certifying operators. States have 1 to 3 years to bring waste-to-energy facilities into compliance with the new regulations.

In 1992, the RCRA was amended by The Federal Facilities Compliance Act, which strengthened the authority to enforce RCRA at federal facilities that up to this time had managed wastes based on different legal acts and with less involvement of the EPA. A further amendment to the RCRA was made in 1996 by the Land Disposal Program Flexibility Act of which was designed to provide regulatory flexibility for the land disposal of certain wastes.

USA signed the Kyoto protocol under President Clinton but could not ratify it under his term. His successor, President Bush Jr., the father of whom also had resisted international actions at the Earth Summit in 1992, was opposed to the agreement and in spite of pressures never presented it to the for ratification in the Senate. Instead, he argued for a national GHG emission reduction policy, but to the disappointment of many organizations never took the initiative to formulate such a proposal. However, in later part of his term, he opened up for discussions on the role of USA in the post-Kyoto negotiations.

In 2002, EPA published "Beyond RCRA: Prospects for Waste and Materials Management in the Year 2020 (2020 Vision)", where the direction of waste and materials management in the United States over the next twenty years was discussed. It identified three overarching goals:

- Reduce waste and increase the efficient and sustainable use of resources.
- Prevent exposures to humans and ecosystems from the use of hazardous chemicals.
- Manage wastes and clean up chemical releases in a safe, environmentally sound manner.

The Clear Skies Act<sup>156</sup> proposed by President Bush Jr. in 2003 was designed to alleviate air pollution-related health and environmental problems and targeted fossil-fired power plants above 25 MW electrical. By a cap-and-trade system the sulphur dioxide emissions were expected to be reduced by 73 %, nitrogen oxides by 67 % and mercury emissions by 69 % in 2018, relative to the emissions in the year 2000. However, the cap-and-trade system, although generating emission reductions would be less restrictive on the individual plant emission permitting than the 1990 CAAA and those opposed to the law saw it as a means to water down the CAAA, it got stuck in a Senate committee in 2005 and was never enacted.

The CAA was amended in 2007 to also include GHG emissions in the NAAQS and by setting new performance standards also for such emissions for specific industries.

In June 2009, the EPA published “Sustainable Materials Management: The Road Ahead”<sup>157</sup>. This report suggests a roadmap for the future based on materials management—fulfilling human needs and prospering, while using fewer materials, reducing toxics and recovering more of the materials used. This strategy would be an important shift of emphasis from waste management to materials management. Shifting to a materials management approach will refocus the way our economy uses and manages materials and products. Furthermore, the EPA developed a Pollution Prevention (P2) Vision<sup>158</sup> in 2010 to provide strategic focus and identify current P2 priorities. The P2 Vision highlights three broad strategic categories: “greening” supply and demand, pollution prevention integration into other procedures, and the delivery of P2 services.

In the area of climate change, President Obama took an active part in the post-Kyoto negotiations that led to the Paris Agreement in 2015, and in 2016 together with the Chinese leadership stated that both countries will ratify the agreement. However, the Trump administration has since decided to leave the Paris agreement.

#### 4.5.1. US Regulations

The most important regulations are highlighted below with special emphasis on the requirements for waste handling facilities and thermal treatment.

**1976 The Resource Conservation and Recovery Act (RCRA)**<sup>153, 159, 160</sup> (as amended later) is the primary law governing the disposal of solid and hazardous waste with the intent to improve solid waste management. It sets clear national objectives:

- Protection of human health and the environment from the potential hazards of waste disposal.
- Conservation of energy and natural resources.
- Reduction of the amount of waste generated.
- Assurance that wastes are managed in an environmentally-sound manner.

Later, also two other objectives were added:

- Prevention of future problems caused by irresponsible waste management
- Clean up releases of hazardous waste in a timely, flexible, and protective manner.

The act, and the broad definition of wastes, for the first time established federal involvement including regulation authority in solid waste management, but it did not pre-empt the responsibility of states for regulating solid waste, with the single exception that states were not allowed to impose

<sup>156</sup> <https://archive.epa.gov/clearskies/web/html/basic.html>

<sup>157</sup> [www.epa.gov/epawaste/inforesources/pubs/vision.htm](http://www.epa.gov/epawaste/inforesources/pubs/vision.htm)

<sup>158</sup> U.S. Environmental Protection Agency 2010-2014 Pollution Prevention (P2) Program Strategic Plan. EPA February 2010

<sup>159</sup> [www.epa.gov](http://www.epa.gov)

<sup>160</sup> RCRA Orientation Manual 2014.Resource Conservation and Recovery Act. EPA 2014

bans on importing or exporting waste for storage, treatment, or disposal. Furthermore, it divided waste into two categories: hazardous and non-hazardous. The latter type of waste was both defined as per a list and per characteristics.

RCRA encouraged states to develop solid waste management plans and offered them technical and financial assistance to implement the plans. Forty-eight states have had their plans and procedures authorized as fulfilling at least the minimum requirements of the RCRA by EPA (Alaska and Iowa are lagging). EPA can delegate certain parts of the implementation to the states if there is a state plan, while the absence of a plan makes the individual waste operators fully responsible for fulfilling RCRA requirements. The Act includes a Congressional mandate for EPA to implement the law. This is done by EPA regulations providing explicit, legally enforceable requirements for waste management collected in Title 40 of the Code of Federal Regulations (CFR), Parts 239 through 282. EPA guidance documents provides direction for implementing and complying with regulations while EPA policy statements specify operating procedures that should generally be followed.

In addition, RCRA charged EPA with gathering information about how to reduce the amount of solid waste generated, about markets for materials and energy recovered from waste, and about solid waste management methods and costs. Although the act itself does not refer to the waste hierarchy, the concept is integrated into the EPA guidelines and regulations.

The present-day act commonly known as RCRA is a combination of the first act in 1970 and all subsequent amendments;

1984 The Hazardous and Solid Waste Amendments (HSWA). It responded to citizen concerns that of hazardous waste disposal, particularly land disposal, was not safe and focused phasing out land disposal of hazardous waste and expanded EPA's corrective action authority.

1992 The Federal Facilities Compliance Act, which strengthened the authority to enforce RCRA at federal facilities.

1996 The Land Disposal Program Flexibility Act of 1996 to provide regulatory flexibility for the land disposal of certain wastes.

The law is organized in sub-titles A-J. Of particular relevance is the solid waste program, RCRA Subtitle D, encourages states to develop comprehensive plans to manage non-hazardous industrial solid waste and municipal solid waste, sets criteria for municipal solid waste landfills and other solid waste disposal facilities, and prohibits the open dumping of solid waste. States play a lead role in implementing these regulations and may set more stringent requirements. Title 40 of the CFR parts 239 -259 contain the regulations for solid waste. The most relevant parts for thermal treatment are:

Part 240 – Guidelines for the Thermal Processing of Solid Wastes gives broad recommendation on the design, operation, monitoring practices, etc. for incineration at large facilities (50 tons per day or more). Among these regulations it can be highlighted that recovery of energy generated should be considered but is not an obligation, emissions should be compliant with the CAA stipulations, otherwise operation must be changed (fuel type capacity reduction) until they are in line with these, more intense monitoring 12-18 month after construction or major changes, solid processing residues must be disposed of in an environmentally acceptable manner.

Part 241 - Solid Wastes Used as Fuels or Ingredients in Combustion Units. This section defines materials that are not seen as wastes when used for combustion purposes. This includes various forms of clean or cleanly processed biomass as well as some wastes and secondary materials, e.g. used tires.

### **Clean Air Act (CAA)**<sup>153, 161, 162</sup>

The objective of the CAA is to protect public health and welfare from different types of air pollution a variety of pollution sources. The basic structure was made in 1970 and later amended in 1977 and in 1990.

The Act requires EPA to set, and every five-year revise as found necessary, the national ambient air quality standards (NAAQS) to, without regard to costs, protect public health with an adequate margin of safety for certain "criteria pollutants". At present, these are: sulphur dioxide, carbon monoxide, particles, nitrogen dioxide, ozone and lead. Secondary standards are set to protect from adverse effects on soil, water, crops, buildings, etc. EPA will, based on a network of air quality monitoring data and after considering state recommendations, determine whether areas do ("attainment areas") or do not ("non-attainment areas") meet the air quality standards for each of the criteria pollutants, or for lack of data are "unclassifiable", then managed as an "attainment area".

Implementing the air quality standards is a joint responsibility of states and EPA with due regard to the economic impacts. In this partnership, states are responsible for developing enforceable state implementation plans (SIPs) to maintain air quality that meets national standards and limit emissions that cause air quality problems in a downwind state. SIPs also contain emission limits and compliance schedules for stationary pollution sources and can also address measures against vehicle emissions. If the implementation is inadequate, the EPA is required to issue a federal implementation plan. In non-attainment areas, a SIP must be developed and accepted within 3 years and show attainment within typically 5-10 years. The plan must address existing stationary sources by establishing reasonably available control measures (RACM) including reasonably available control technology (RACT) and must achieve annual emissions reductions that represent "reasonable further progress" (RFP) toward meeting the standard on time. New major stationary sources require a preconstruction permit. This entails emission controls meeting the "lowest achievable emission rate" (LAER) defined by the best installations of the same kind. Furthermore, under this permit program, new plants cannot be built in nonattainment areas unless the added emissions are offset by reductions in pollution from existing facilities in the area.

In attainment areas, the Prevention of Significant Deterioration (PSD) program was added in 1977 requiring SIPs to include measures to prevent existing air quality from deteriorating from pollutants increasing above a maximum allowable concentration. This also includes a preconstruction PSD permit program. The permit requires that the added emissions from a new installation, designed with consideration for cost and other factors, that are shown not to contribute to an increase in excess of the allowable increment or any national ambient air quality standard, or that the added emissions will not have an adverse impact on in "Class I" area such as national parks, etc.

To give regulatory guidance for permitting, the EPA sets emissions standards for new and modified stationary pollution sources for industrial installations relevant for the pollution emission and control. These "new source performance standards" (NSPS) typically apply to industrial facilities such as power plants and manufacturing facilities, but also in cases for smaller equipment e.g. wood stoves. NSPS often limit criteria pollutants or precursors, but also since 2007 can apply to other pollutants, including greenhouse gases. EPA defines the level of emissions performance achievable through the best demonstrated control system of emission reduction "best available control technology" (BACT), considering cost and other factors, but does not specify the technology to be used. Updating of standards is required at least every eight years.

---

<sup>161</sup> <https://www.epa.gov/clean-air-act-overview>

<sup>162</sup> The Clean Air Act in a Nutshell: How It Works. EPA March 22, 2013

Already in 1970, the CAA had required EPA to regulate hazardous air pollutants on a pollutant-by-pollutant basis, based on risk. In 1990, EPA had only managed to regulate some sources regarding seven pollutants. In the 1990 CAAA Congress listed nearly 190 hazardous air pollutants (but gave EPA authority to modify the list if warranted) and obliged EPA to issue “maximum achievable control technology” (MACT) emissions standards for new and existing major industrial sources of these pollutants within 10 years. These NESHAP (New Emission Source Standards for Hazardous Pollutants) standards require existing higher-emitting sources to reduce their emissions to at least the level already achieved by the average of the top-performing 12 % of existing emitters in an 8-year review cycle of the standards. When EPA issued its acid rain rule under the 1990 Clean Air Act amendments, it included waste-to-energy plants in a list of renewable energy generation facilities.

With regard to specific industries, EPA was required to regulate hazardous air pollutant emissions from electric utilities, resulting in that final standards were issued in 2012. The US Congress also set a goal of reducing the annual SO<sub>2</sub> emissions by 10 million tons below the 1980 level by means of a market-based emissions capping and trading approach. The initial phase, starting in 1995, applied to over 100 large coal-fired power plants. The second phase, starting in 2000, brought smaller plants and cleaner plants (coal-, gas-, and oil-fired) into the program.

Also, to control emissions from solid waste incinerators burning municipal, hospital, medical, and other commercial and industrial wastes standards similar to MACT were introduced for various categories of incinerators for specified criteria and hazardous air pollutants. Furthermore, EPA was also required to issue guidelines for states to control emissions from existing installations. EPA initially issued emissions guidelines for large municipal waste combustors (with capacities of 225 tons or more per day) in February 1991, but in 1996 the regulations became even more stringent.

The amendments required EPA to regulate emissions from facilities producing 10 short tons or more of any one pollutant in a year or 35 short tons per year of any combination of pollutants. Separate emission guidelines and new source performance standards (where states had the responsibility to ensure operator compliance within three years) were issued for waste treatment facilities such as landfills and in 1995 for large municipal waste combustors<sup>163</sup> (processing 225 tons per day or more) and in 1993 for small waste combustors<sup>164</sup> (processing 36 to 225 tons per day or less), see Appendix 2, Tables A2.7 and A2.8. The basis for the emissions standards reflects the maximum achievable control technology (MACT). The new regulations covered particulate matter, acid gases (sulphur dioxide and hydrogen chloride), nitrogen oxides, carbon monoxide, metals (lead, cadmium, and mercury), dioxin, and dibenzofurans. The standards include limits on specific emissions, requirements on monitoring emissions, performance standards for pollution control technology, and requirements for training and certifying operators. To which extent these regulations also apply to other forms of thermal treatment of wastes such as e.g. gasification and pyrolysis is not clear, in particular if the gas is cleaned<sup>165</sup>.

## 5. Gasification technologies applied to waste

Gasification is by definition the conversion of a solid or liquid fuel, but also e.g. various waste fractions in the context of this report, to a gaseous energy carrier with a useable heating value that can be used for a number of purposes. Gasification can allow fuel contaminants to be isolated from the gas, e.g. as an ash separation method, or to allow other fuel contaminants to become available for cleaning, prior to the use of the energy value of the gas.

---

<sup>163</sup> 40 CFR Part 60

<sup>164</sup> 40 CFR Part 62

<sup>165</sup> Environmental Advantages of Gasification: Public and Agency Awareness. Steve Jenkins. Gasification Technologies Conference 2015. October 13, 2015

One of the main advantages of gasification with respect to conventional combustion refers to the versatility of applications of the product gas. The gas produced by gasification can find use as a fuel in kilns or furnaces to substitute other conventional and mostly fossil fuels. Another use of the product gas is in a prime mover, where an unconverted solid fuel could not be used, thereby allowing a higher conversion of fuel energy to electrical energy than could otherwise be achieved by e.g. combustion to generate steam to power a steam turbine. Finally, the purpose may be to transform the solid fuel in such a way that specific chemical compounds can be isolated, e.g. CO and hydrogen, for use as a basis for the synthesis of chemical compounds such as e.g. methanol. Most of the above applications require gas cleaning to some extent. Gasification systems and applications using gas cleaning is in the focus of the report, as such systems can utilize the potential of gasification technologies to its full extent.

Over the last twenty years, significant advances have been made in the field of gasification of biomass and wastes and the associated gas cleaning, even if it for biomass and wastes is still not a fully industrial technology. There have been some recent reviews providing details on the subject<sup>166, 167</sup>.

## **5.1. PRINCIPLES OF GASIFICATION PROCESSES**

The conversion of a solid fuel to a raw product gas encompasses several stages, Figure 24:

- drying of the residual moisture in the fuel
- the pyrolytic decomposition of the fuel to;
  - additional water vapor emanating from the decomposition,
  - light gases such as CO, CO<sub>2</sub>, H<sub>2</sub>, CH<sub>4</sub>, C<sub>2</sub> and C<sub>3</sub> hydrocarbons,
  - light aromatics benzene, toluene and xylene (BTX),
  - heavier hydrocarbons from naphthalene (C<sub>10</sub>) and higher including PAH compounds generally referred to as tars, most commonly in the vapor phase at gasification temperatures and
  - solid carbonaceous residue generally referred to as char.
- The conversion of the char by direct oxidation with oxygen to mainly CO<sub>2</sub> or by gasification reaction involving water vapor and CO<sub>2</sub> to CO and H<sub>2</sub>, or CO, respectively.
- Secondary gas phase reactions such as the water gas shift, steam/CO<sub>2</sub> reforming of hydrocarbons and other less defined reactions of hydrocarbons etc.

---

<sup>166</sup> Process and technological aspects of municipal solid waste gasification. A review. U. Arena. Waste Management 32 (2012) 625–639.

<sup>167</sup> Waste Gasification by Thermal Plasma: A Review Waste and Biomass Valorization. September 2013, Volume 4, Issue 3, pp 421–439

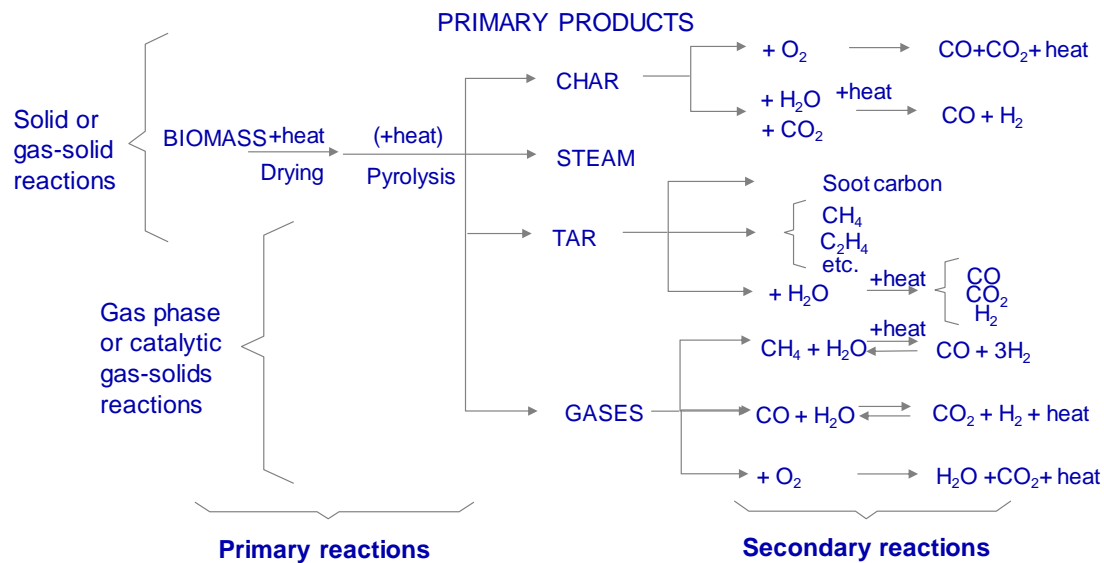

**Figure 24 Gasification reaction scheme**

In addition to the reactions of the combustible part of the waste fuel, there are also reactions involving the inorganic ash constituents and bed materials present. Figure 25 schematically depicts the changes occurring in the ash during gasification/combustion.

The ash is both contained in the fuel matrix and as excluded minerals e.g. earth and sand. During the pyrolysis stage, and under the locally reducing conditions in the fuel particle, certain elements can volatilize to the gas phase and further devolatilization of inorganics can occur as temperature increases and the chemical environment changes during char oxidation. In the gas phase, certain elements may precipitate from the gas homogeneously and form very fine particles, in particular during gas cooling. More commonly, other particles present, e.g. from ash or bed material serve as condensation nuclei. Having condensed, many inorganics, but in particular alkalis can interact chemically with the condensation nuclei on the surface and form a layer of e.g. sticky or low melting, "glassy" material that causes agglomeration of the particles, particle fouling of surfaces and even sintering or melting. These phenomena have impacts on operation of the gasifier, from generation of pressure drop, channelling of gas and oxidant, temperature deviations, defluidization, corrosion of metals and refractories as well as of fouling and plugging of gas coolers.

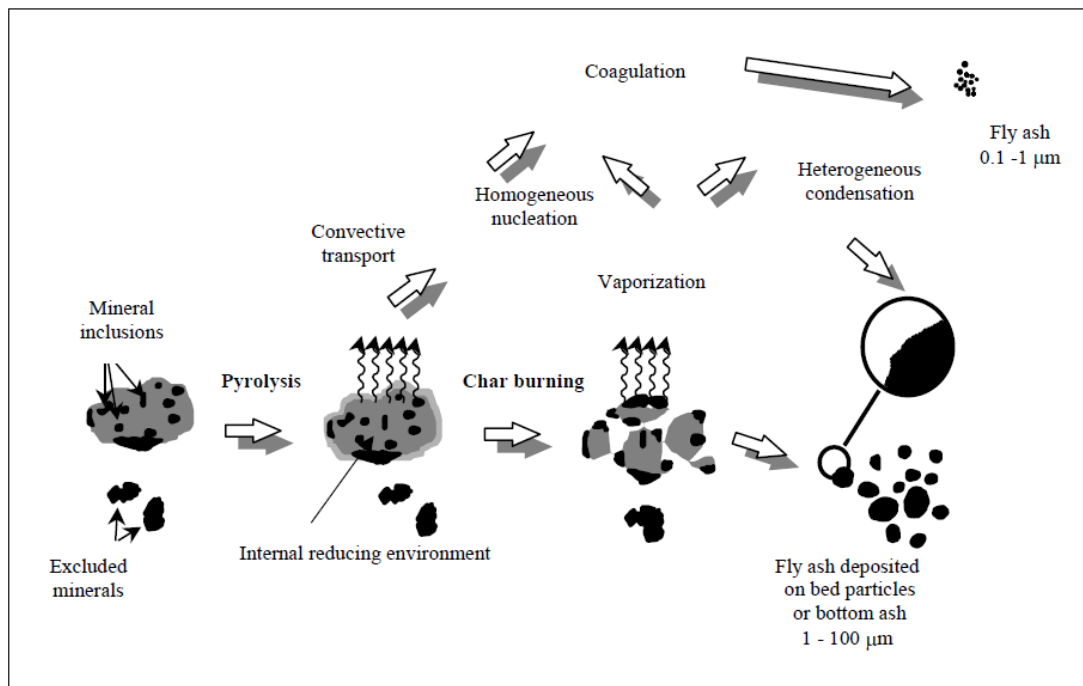

**Figure 25 Schematic description of ash behaviour during gasification.** <sup>168</sup>

Most of the main gasification reactions are endothermic. The main exception is oxidation of char (or combustible gases) by oxygen, but also the water gas shift towards hydrogen and the pyrolysis in certain temperature windows, which are also exothermic. Therefore, there is a need to supply to, or generate energy within the gasifier to balance the overall conversion. There are two main principles used for the supply of energy to the gasification process: autothermal and allothermal gasifiers, respectively.

### 5.1.1. Autothermal and allothermal gasifiers

**Autothermal** gasifiers (also referred to as direct gasifiers) provide the necessary heat of conversion by adding an oxidant to achieve partial oxidation of the fuel within the gasification reactor. This releases energy directly in the reactor where it is consumed. Autothermal conditions are easy to achieve using air or oxygen. Overall the complexity of the gasification process is reduced compared to allothermal gasifiers. However, the heat release occurs in the zone of contact between the oxidant and a combustible, and either requires a good internal heat transfer to even out the temperature or causes a temperature gradient inside the gasifier.

The choice of oxidant (air or oxygen) has a large impact on the gas quality. If air is used, the product gas also contains the nitrogen associated with the air. This reduces the heating value of the product gas, (LHV is about 4-6 MJ/Nm<sup>3</sup>); if a mixture of oxygen and steam is used, the LHV of the resulting product gas is about 10-12 MJ/Nm<sup>3</sup>. In addition, the high nitrogen content in the product from an air blown gasifier also makes the gas unsuitable as a synthesis gas to produce liquid energy carriers or chemicals, so mixtures of oxygen and steam are used as gasification agent exclusively used for such products. The air separation unit then also adds to the overall cost of the plant, in addition to the gasifier, and this also pushes the gasifier to a larger scale for economic reasons.

<sup>168</sup> Ash-forming elements and their chemical forms in woody biomass fuels. J. Werkelin. Åbo Akademi Tekniska Fakulteten, Processkemiska centret. REPORT 08-06



**Allothermal** (or indirect) gasifiers are characterized by the fact that heat is provided from a separate heat source outside of the gasifier reactor, i.e. the processes of heat production and heat consumption are physically separated. The fuel is fed to, and gasified, in the gasification reactor to which the necessary heat is transferred. There are two main types of allothermal reactor. One uses a solid heat carrier (sand or larger aggregates) that is circulated between the gasification and combustion reactors, respectively. The hot energy carrier coming into the gasification reactor releases heat to drive the gasifier reactions, and when leaving to the combustion reactor also withdraws a major part of the remaining solid residue (char). In the combustion reactor, which is operated at a higher temperature than the gasifier, the remaining solid char from the gasification reactor is combusted, and the energy carrier is thereby reheated before being returned to the gasifier. By the use of suitable seals between the reactors, e.g. loop seals in fluidized beds, the contact between the product gas and the air, and between the oxygen containing flue gas and the product gas, respectively, is minimized. However, depending of the characteristics of the bed material there is always some transport of surface-bound oxygen together with the circulating bed material, which can range from negligible for most low porous sands to very significant for materials undergoing an oxidation-reduction cycle when being moved from the combustor to the gasifier, and back.

The second type is the heat-integrated gasifier, where part of the product gas, or char residues, are separated from the product gas and are burnt, and via some form of indirect heat exchanger the energy in the hot flue gas is transferred to the gasifier by a combination of radiation and convective heat transport.

In contrast to autothermal gasifiers where only one product gas stream is produced, allothermal gasifiers generally produce two separate gas streams: a medium calorific product gas stream having a low content of nitrogen from the gasification reactor, and a flue gas stream from the combustion reactor. Both streams need to be cleaned to the standard required for the gas end user (product gas), or for release to the stack (flue gas), respectively. The production of an almost N<sub>2</sub>-free gas without the need for pure oxygen is one of the advantages of allothermal over autothermal gasification processes. The LHV of the product gas is about 12-14 MJ/Nm<sup>3</sup> if steam is used as gasifying agent.

One additional advantage of the allothermal system is that all carbon containing residual streams from the product gas cleaning (such as carbon-containing fly ash or tar liquids separated) can be recycled to the combustion reactor and incinerated. Thereby the energy content of the initial solid fuel is efficiently recovered in the process (complete carbon conversion) which also make secondary waste by-products more acceptable.

A disadvantage is that two gaseous product streams need to be cleaned, instead of just one product gas stream in the case of an autothermal reactor. For waste processing this has some implications, unless only a fully cleaned gas is used as a heat source. Since there is a combustor firing waste, from the EU definition, such a gasification system using waste will always be an incinerator irrespective of the use of the gas, which may not be the case for an autothermal gasifier if the product gas is not used for power and heat.

**Hybrid gasifiers** contains elements of both the autothermal and allothermal type of gasifiers. Indirect plasma gasifiers transfers heat from electricity via an injection of a plasma gas (most often air) as a heat carrier to the gasifier, most often air. Direct plasma gasifiers use a plasma arc to transfer heat to a melt within the gasifier reactor. But plasma gasifiers also use air or oxygen as in an autothermal reactor to limit the electric energy consumption for the plasma from becoming excessive.

Other examples of a hybrid gasifier are when an external regenerative pre-heating of the gasifier air or steam to very high temperatures is used to supply a large fraction of the energy to the gasifier as sensible heat, thereby reducing the oxidant flow.

### **5.1.2. Operating conditions for waste gasifiers and other gasifiers**

Due to the fuel properties of most wastes, gasifiers designed for coal are typically not well-suited for wastes. Instead, waste gasifiers are for the same reason, i.e. fuel properties, better suited for to biomass gasification systems. However, there are two main differences between waste gasifiers and the design used for biomass gasifiers. First, due to the fact that waste as a fuel, and in particular unsorted waste, has a large variability in size and composition and contains both heavy and light as well as combustible and non-combustible material, both the feed system and the gasifier must be able to handle both coarse and fine materials and a varying degree of fuel quality.

Secondly, even when using high grade pre-treatment by separation, the non-combustible, "ash" content of waste fuels is still higher than for a typical biomass fuel, therefore the ability to extract ash and to control ash inventory is important.

To manage a very variable fuel composition and appearance tunnels, kilns, grates and shaft furnaces are well suited in much the same way as for similar incineration plants using combustion. But, as is also the case for incinerators: fluidized beds can cope with waste when shredding ensures that the remaining fuel particles are not too coarse to fluidize and when most non-combustible material is already separated out, in particular metals and glass that can cause bed-related problems.

For most conventional fuels, the gasifier operating temperature is defined to achieve a good carbon burn-out and in some cases to reduce tars. The char conversion is often the rate limiting step for carbon conversion, and there are benefits from higher operating temperatures through the combined action of the steam and CO<sub>2</sub> gasification kinetics and the fast reaction with the additionally oxidants used to reach the temperature. The ash mainly constitutes of mineral oxides and is half-way inert during these reactions. If molten ash gasifiers are used, then also the viscosity of the slag is guiding the operating temperature.

However, in comparison with woody biomass, waste materials have a high content of paper, plastics, etc. and a lower content of wood. The loss of weight during the pyrolysis is therefore higher and the formation of char is reduced. Many so-called gasifiers for waste operate at 400-600 °C, as opposed to 800-900 °C for biomass gasifiers, to avoid partial or complete oxidation of metals. This allows the recovery of the metal and avoids operational issues related to the melting of glass particles contained in the fuel. If the carbon content is an issue, the char can be separated and recycled. Gasifier operating in the normal temperature range, 800-900 °C causes metals to be oxidized and thereby reduce their value, even if some energy is released in the gasifier, and the ash becomes more inert.

Low temperature operation obviously has a negative impact on tar formation, see Section 6.2.2, but since most so-called gasifiers have a close-coupled combustion stage or high-temperature gas treatment stage immediately downstream of the gasifier (and thereby also meeting the IED requirement for 2 s residence time above 850 °C), this has limited impact on the final gas quality.

The other aspect is that various hazardous inorganic materials are present in the ash, such that there is a desire to melt the ash to form vitrified slag to reduce the leaching of the ash. In the case that there is a high metal content in the ash, this can be combined such that by adding coke reduced metals can be recovered from the gasifier bottom.

### 5.1.3. Typical bulk gas compositions

The typical composition of a dry gas produced during the biomass gasification process is shown in Table 8. As can be seen, the gas components from oxygen and steam gasification differ significantly in their respective concentration. During air or oxygen gasification, combustion products (CO<sub>2</sub>, but also H<sub>2</sub>O) are present in the product gas to dilute the combustible compounds and take part in the chemical reactions, mainly in char gasification and water gas shift reaction but also for reforming of hydrocarbons. Steam gasification results in a higher concentration of hydrogen in the product gas.

For allothermal steam gasifier where part of the fuel is converted in the combustor and therefore does not contribute to the gasifier gas volume the specific gas yield is lower than for autothermal reactors as the gas is diluted with more H<sub>2</sub>O and CO<sub>2</sub> combustion products, and also from N<sub>2</sub>, if air is used as an oxidant.

Also, methane and also other hydrocarbons (including tars), which exclusively emanate from the fuel devolatilization, are higher in concentration in the indirect gasifier, both due to the lower dilution of other species, but also because the (peak) operating temperature is lower than in other gasifiers, and in particular for entrained flow and downdraft fixed bed gasifiers where the very high operating temperature results in the decomposition of hydrocarbons.

**Table 8 Typical bulk gas compositions for three different gasification systems<sup>169</sup>**

Gas composition vol. %	Air gasification (Fixed bed)	Oxygen gasification (Entrained flow)	Steam gasification (Fluidized bed)
CO	13–18	45–55	25–30
CO <sub>2</sub>	12–16	10–15	20–25
H <sub>2</sub>	11–16	23–28	35–40
CH <sub>4</sub>	2–6	0–1	9–11
N <sub>2</sub>	45–60	0–1	0–5
LHV MJ/Nm <sup>3</sup>	4–6	10–12	12–14

## 5.2. GASIFICATION REACTORS

There are several configurations of gasification reactors, Figure 26 to Figure 29. The gasifiers are typically grouped based on their flow pattern and gas-solid contact into moving beds (often referred to as fixed beds and divided by the flow pattern into co-current or downdraft types and countercurrent or updraft types, respectively), fluidized beds and entrained flow gasifiers. To these generic gasifier types, also other gasifiers can be incorporated on the basis of their functions, i.e. grate and kiln gasifiers are typically classified as moving bed gasifiers, as is some of the indirect heat carrier gasifiers. Indirect gasifiers are also often based on fluidized beds, and heat integrated processes have different combinations of moving bed and entrained flow reactor types.

In addition, there is the entrained flow or suspension gasifier, where fine particles (pulverized fuel) are injected with the oxidant in a very dilute stream in a burner, and which is commonly used at large scale (several hundred MW thermal in terms of fuel feeding) for coal and oil in pressurized operation. However, this gasifier type is not suitable for wastes in general. Entrained flow gasifiers require a pumpable and atomisable liquid, or fine (< 0.1 mm) homogenous solid fuel particles. These are constraints that restrict waste gasification in most circumstances, unless only special qualities of fuel, (e.g. liquid oil wastes, dried sludges) are considered.

<sup>169</sup> Status report on thermal biomass gasification in countries participating in IEA Bioenergy Task 33/2016. J. Hrbek. IEA Bioenergy Task 33. April 2016.

The remaining gasifier types, i.e. updraft moving bed (or the equivalent of grate gasifier), indirect double bed gasifiers and stationary (bubbling) and circulating fluidized beds have all been used for waste. So-called plasma gasifiers are in many cases also mainly of the updraft moving bed type, or in one case a fluidized bed, and in a few cases molten bath gasifiers.

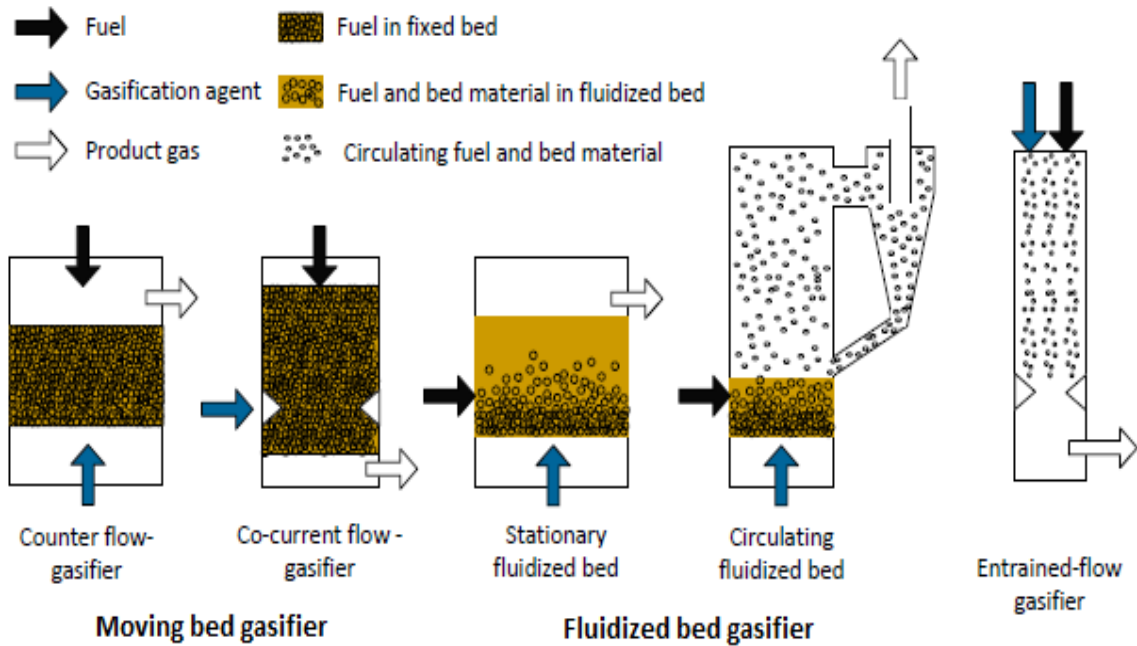

Figure 26 Different autothermal (direct) gasification reactor types<sup>169</sup>

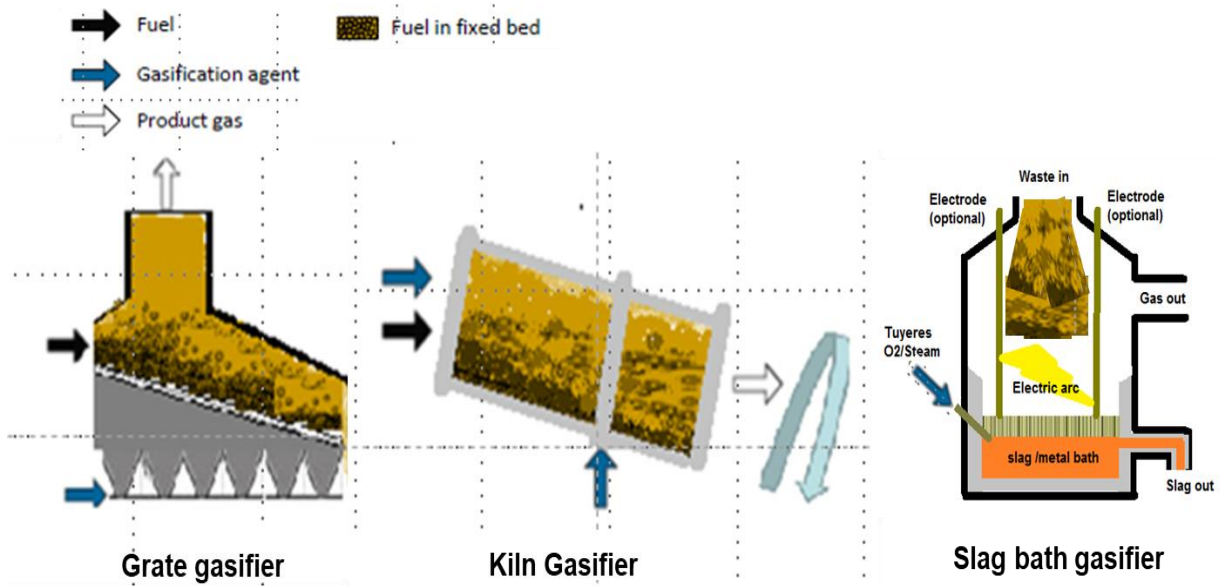
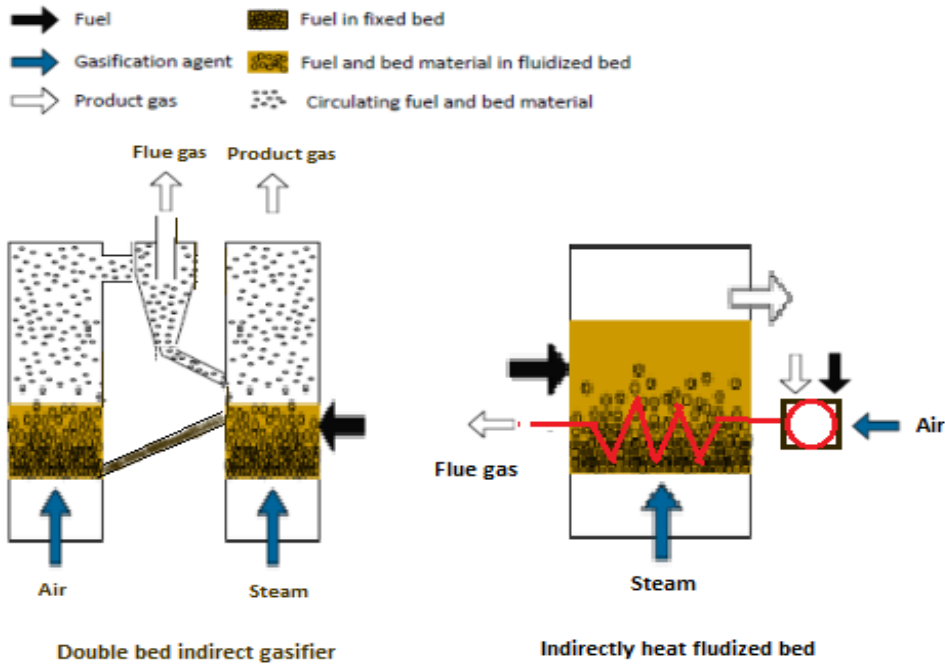
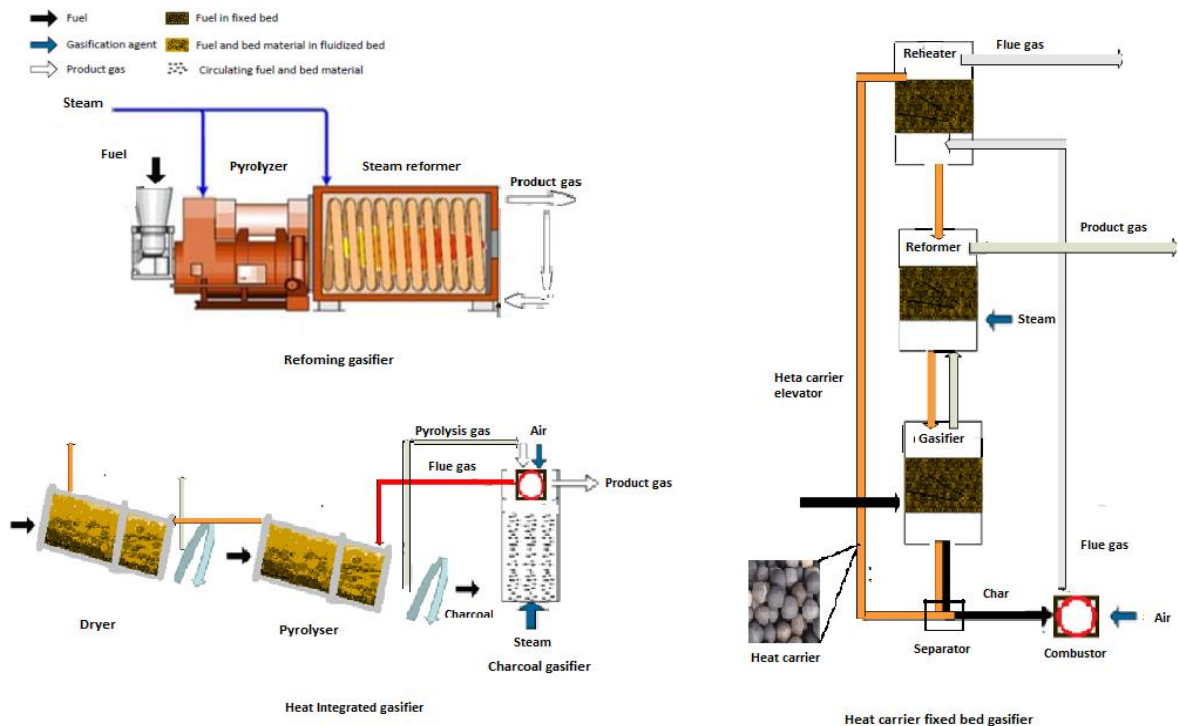

Figure 27 Different autothermal gasifiers



**Figure 28** Different allothermal gasifiers



**Figure 29** Different allothermal gasifiers

Table 9 highlights some of the characteristics of different gasifier types in terms of the fuel particle size that can be accepted and the operating conditions. One key parameter is the superficial velocity. Since the specific gas production does not vary too much between different gasifiers, for a specific fuel using the same oxidant or type of indirect heating, the superficial velocity is more or less directly related to the gasifier capacity in kg/s, m<sup>2</sup>, or W/m<sup>2</sup>. Since vessels larger than 3-4 m in

diameter are difficult to produce in ordinary workshops, this also sets the limits for the possible gasifier capacity per unit, and where pressurization can be used to increase the throughput. On the other hand, a high velocity and the requirement for a minimum reaction time or particle disengagement time defines the height of the gasifier. Therefore, moving beds, irrespective if down- or updraft, with low gas velocity, are only used for small scale applications.

Another key parameter is the operating temperature: high-temperature potentially causes ash agglomeration issues, so most gasifiers (fluidized beds and moving beds) operate below 900-950 °C, or lower due to ash issues. Entrained flow gasifiers operate at distinctly higher temperatures as these relies on melting the ash and to remove it as a free-flowing slag. At these high-temperatures, the additional benefit is the thermal decomposition of tars and hydrocarbons. To reach very high-temperature requires oxygen rather than air and the oxidation consumes more of the fuel energy, thereby reducing the gas heating value and the cold gas efficiency. Furthermore, the short reaction time and high demands on feeding stability requires a high level of fuel pre-treatment that entails costs.

In an updraft gasifier, the hot gases generated from the oxidation at the bottom passes through the bed of fuels undergoing pyrolysis and drying, so that the sensible energy of the product gas can be used for preheating of reactant gases, and the outlet temperature at the top is distinctly lower than the bottom temperature. This leads to a high efficiency, but the tar-laden pyrolysis gases never pass through a high temperature zone, and hence the tar content in the outlet becomes extremely high and becomes a limiting factor for the applicability of the technology.

The internal mixing in the gasifier relates to the capability for suppressing local overtemperatures but also the contact between the gas and the bed materials, which is of importance for catalytic reactions for tar decomposition. So, when selecting the gasifier type there is a number of parameters to consider and relate to the fuel properties, the application and its commercial capacity.

**Table 9 Typical gasification reactor characteristics**

Gasifier type	Moving bed	Stationary fluidized bed	Circulating fluidized bed	Entrained flow
Characteristic				
Capacity range MW Thermal (Typical op. pressure)	Downdraft < 1 Updraft < 10 (atmospheric)	10-50 (atmospheric) < 200 (< 3 MPa)	20-150 (atmospheric)	100-400 (1-3 MPa)
Bed material, particle size, mm	none	0.1-0.5	0.1-0.4	none
Particle size, fuel, mm	10-100	1-100	1-100	< 1 mm
Operating temperature, °C	800	800, bottom, 200-300, top	800-950	1 400-1 500
Gas superficial velocity, m/s	0.1-0.5	0.5-1,5	4-8	15-25
$U_{gas}/U_{terminal}$	<<1	<1	>1	>>1
Gas mixing	Near plug flow	Complex	Dispersed plug	Near plug flow
Solids mixing	Very low	High, complex	High, complex	Low
Voidage, %	0.4–0.5	0.5–0.85	(0.5) 0.85–0.98	0.98–0.998
Temperature gradients	High	Low	Low	High
Tar content in gas, g/Nm <sup>3</sup>	Downdraft < 1 Updraft >>10	> 10	> 10	<<1
Particles in gas g/Nm <sup>3</sup>	0.1-0.2	0.1-1	2-20	1

### 5.2.1. Co-current (downdraft) moving bed gasifiers

Down-draft moving bed gasifiers, see Figure 26, have fuel feeding from the top and the bed formed moves slowly downward while the fuel forming the bed undergoes drying and pyrolysis in fairly well-defined zones as it gradually approaches the lower and hotter parts of the gasifier. The moisture evaporated pyrolysis gases generated also flow downwards co-currently with the moving bed, this being the root of the generic name. In the lower part of the gasifier, there is typically a section with smaller diameter than in the top of the gasifier, the throat. The oxidant, almost exclusively air, is injected around the circumference of the gasifier just above, or in the throat. The air reacts with char and gases present to create an incandescent char bed glow zone at approximately 1 000°C. The tar-laden pyrolysis gases pass through the pores of this glowing bed and the temperature and contact with the char causes decomposition of the tars. This oxidation zone can for well-designed units operating on a suitable fuel give tar contents as low as below 1 g/Nm<sup>3</sup>. In addition, steam and CO<sub>2</sub> in the gas react with the char producing additional hydrogen and carbon monoxide. The product gas continues further downward and leaves the gasifier just above the grate at the bottom of the vessel at approximately 800°C, this being controlled by the air injection. Ash and unreacted char fall through the grate and are removed. In some cases, the product gases pass upwards in an annulus outside the gasifier such that heat is transferred indirectly through the wall to assist in the pre-heating and pyrolysis of the fuel bed above the throat.

The fuel material in the bed must have sufficient mechanical strength so as not to collapse by the weight of the material on top of it to maintain a bed porosity and voidage to allow stable flow fields for the gas in order to maintain a reasonable pressure drop. Bed fines or friable material that can be entrained by the gas flow can cause blockage of pores and flow maldistribution in the throat section leading to degraded performance and tar slip. This favours fuels of a well-defined size not containing too much fines, and for which ash properties (melting, sintering) are not too difficult.

Downdraft fixed beds is the gasifier of choice at the smallest capacity, below 1 MW. The limit is in this case the throat section. Experience shows that the uniform flow through the char bed in the throat section is essential for sufficient tar decomposition to be achieved. Since capacity scaling means increasing both the gasifier and throat diameter, at some point the air injection is not sufficiently mixed into the gas over the entire cross section, such that the porosity and the movement of the fixed bed become less uniform causing channelling and tar by-pass in the throat bed.

Using waste materials with a very variable composition and shape and size of the fuel particles as a fuel is therefore quite challenging in this design. This sensitivity to the fuel characteristics combined with the low capacity per gasifier inherent to this design means that it is rarely used for e.g. MSW or other wastes, but may be used for industry-specific, suitable materials. Inorganics in waste materials, both metallic or compounds, that have a high enough vapor pressure will tend to vaporize into the gas at the high temperature in the throat zone.

### 5.2.2. Co-current (updraft) moving bed gasifiers

In moving bed updraft gasifiers, see Figure 26, the oxidant, most often air, is injected at the bottom of the gasifier and the product gas flows upward and exits at the top of the gasifier, this upward flow giving this type its generic name. In such gasifiers well-defined temperature zones are established, from the fuel drying section at the fuel inlet, the pyrolysis zone beneath the drying zone and the reduction zone where the combustion gases react with the char from pyrolysis and finally the combustion or glow zone at the bottom where the oxidant (air or oxygen combined with steam) is injected. The final burn-out of the char occurs on a moving grate through which the ash falls through into the ash outlet. The oxidant is injected at a rate such that the heat release from partial oxidation of the fuel balances the gasifier heat demand to a desired exit temperature. The hot

product gas from the glow zone going upwards is the heat carrier that heats up the fuel to reach the temperature to achieve pyrolysis and the drying prior to extracting the cooler gases at the top at a temperature where excessive tar condensation does not occur, typically at 200-400 °C. The gas from an updraft gasifier has very high tar content, 40-100 g/Nm<sup>3</sup> since the fuel is pyrolyzed slowly and the tar formed goes away with the gas towards the top, such that it is never exposed to high temperature. In the case of waste, where the organic structure can contain nitrogen, fluorine, chlorine, bromine, sulphur, etc., the tar composition is also more complex than from pure lignocellulosic sources.

For this type of gasifier, the far higher content of tars contained in the product gas and the low gasifier exit temperature results in that the tars are partially in the gas phase and partially present as condensed aerosols already at the exit of the gasifier. For this type of gasifier, more than for other types, tars not only constitute a gas cleaning problem, but also a waste problem and an energy balance issue.

As already explained in Section 5.2.1, the fuel material in the bed must have sufficient mechanical strength so as not to collapse by the weight of the material on top to maintain a bed porosity and void to allow stable flow fields and reasonable pressure drop for the gas, but also to avoid entrainment of bed fines or friable material that can be carried away by the gas flow. This favours fuels of a well-defined size not containing too much fines, and for which ash properties (melting, sintering) are not too difficult. As wastes in most circumstances do not fulfil all of these criteria and moreover have difficulties in establishing a good and stable bed, co-feeding of coke is often used. The coke provides a bed of sufficient strength and void space for gas and melts to pass through the bed. The slow-reacting coke can also provide the fuel required in the bottom of the gasifier to melt the ashes, which is desirable for wastes, while maintaining a reducing atmosphere. For dry operation, the bottom temperature typically does not exceed 800-900 °C while for slagging operation where ash is removed as a melt, the temperature is considerably higher, 1 500 °C or more. Also, in this type of reactor, inorganic compounds of sufficient vapor pressure will tend to vaporize, but as the gas is cooled in contact with fresh fuel, these can re-condense and be returned to the glow zone, such that there is an internal accumulation effect, ultimately resulting in that such materials leave the reactor as aerosol particles or with the bottom ash. This can be an advantage over other gasifiers if such materials can be preferentially recovered e.g. in bottom ash slag.

Updraft fixed beds have traditionally been rather small in capacity, typically 10 MW thermal or less, being constrained by the low gas velocity necessary to avoid excessive entrainment of fuel particles with the gas and the practicalities of a limited vessel diameter for manufacturing reasons. However, for some applications, e.g. coal gasifiers operating at elevated pressure and plasma gasifiers, fixed beds have been scaled up to over 100 MW thermal in capacity.

For historical reasons (as updraft gasifiers have been widely used in the past in various industries as they can meet capacity requirements better than downdraft gasifiers and since also before the domination of petroleum, the tar was seen as an asset rather than a problem), updraft fixed beds have been deployed also for gasification of MSW and RDF, and for co-gasification of wastes with coal. Such developments are described in reference<sup>4</sup>. The authors conclude that the experience in the past seem to indicate that the updraft gasifiers have suffered more operational issues than kilns and other types of moving beds, but that high-temperature operation in the glow zone to achieve ash melting appears advantageous for wastes relative to dry ash handling, even if it may require additives like coke, etc.



### 5.2.3. Other forms of moving bed gasifier

In addition to downdraft and updraft moving bed gasifiers, there are also rotating kilns or tunnel gasifiers, see Figure 27, where the fuel is fed co-currently with the oxidant (typically air), being heated and pyrolyzed while moving through the reactor. The difference to the co-current downdraft reactor is that in this case the movement in the kiln or channel generates more or less mixing in the bed of solids than in the moving bed.

There are also grate type gasifiers that resemble updraft moving bed gasifiers, i.e. the fuel is moved as a bed on an inclined or moving grate, or on a belt in a furnace tunnel while the oxidant is added from below, such that drying and pyrolysis occurs close to the feed point and burn-out of the char at the ash exit point. This is a kind of cross-flow arrangement where the product gases from all sections in an updraft gasifier is generated separately and then mixed, unlike the countercurrent passage of the gas from one section through the next in an updraft gasifier.

There are hybrid moving bed gasifier designs that combine elements of the updraft and downdraft gasifiers. Through the use of baffles, staged points of air introduction and ejectors, the gas flow is directed to hotter zones, several combustion zones are created, or the most tar-laden gas is extracted as formed and re-entered to a high temperature zone to promote tar reduction.

For non-uniform materials such as wastes, one of the advantages of kiln, grate or tunnel gasifiers, relative to the updraft and downdraft moving bed gasifiers is that the movement of the bed is ensured by mechanical means and not only by gravity, which improves the internal mixing of the fuel.

As a summary of Sections 5.2.1-5.2.3, Table 10 gives an overview of developers/suppliers of waste moving bed pyrolysis and gasification units.

### 5.2.4. Fluidized bed gasifiers

In fluidized bed gasifiers, see Figure 26 and Figure 28, the reaction space contains a sand-like bed material (particle size in the range of 0.1 and 1 mm) that is fluidized or entrained by the oxidant gas (air or oxygen), steam or mixtures thereof being added in the bottom. Autothermal or direct gasifiers use an oxidant, and allothermal or indirect gasifiers use steam without an oxidant being fed to the gasifier section.

In the case of a stationary (or bubbling) fluidized bed the bed material is kept suspended by the gas in a defined bed volume through which gas in the form of interstitial gas and bubbles pass. Above the bed there is a freeboard section used for disengagement of particles mainly ejected by bubbles erupting on the bed surface. This gives a density profile in the reactor of high and uniform density from the fluidizing gas injection level to the top of the bed, and a low density close to the gas density in the freeboard section from the upper bed level to the gas exit.

In a circulating fluidized bed, the gas velocity is higher than for a stationary (bubbling) bed and the bed material or loose clusters of bed material are carried up in the gasifier shaft. By a radial transport some of this material is moved to the wall and transported back to the bottom by gravity as part of the wall layer sliding down (the flow in a large diameter bed establishes a core-annulus type of flow, with the gas-solid suspension flowing upwards and the wall layer moving sand bed moving downwards). The remainder of the solid suspension is carried out by the gas to an external primary particulate separator, typically a cyclone, from which it is returned to the bottom of the gasifier by means of a recycle line with a moving bed of solids. The effect is huge net circulation rate between the bottom and the top of the reactor.

**Table 10 Developers of moving bed waste pyrolysers and gasifiers**

Moving bed waste gasifiers					
Developer	Type	Oxidant	Tar Gas cleaning	Use of gas	Comments
AlterNRG	Updraft (shaft)	Air or O <sub>2</sub>	Thermal plasma	Various	<i>Fka Westinghouse</i>
Ansac	Indirect kiln	Air		CHP	
Biomass Power	Grate	Air	Total oxidation	CHP	
Chinook	Indirect batch	Air	Total oxidation	CHP	
CHOPEX	Grate (later changed to PRME gasifier)	Air	Thermal plasma		<i>Fka CHO</i>
Citorn Holding	Kiln				
ConcordeBlue	Updraft	Indirect	Thermal	Various	<i>Fka Blaue Turme</i>
ConTherm	Indirect drum pyrolysis	Air	Total oxidation	CHP	Burgau plant closed in 2015
Covanta	Grate	Air	Total oxidation		
Energos	Grate	Air	Total oxidation	CHP	
Entrade	Downdraft?		?	CHP	
Envitec	Updraft shaft	Air	Plasma	CHP	
Greene	Indirect kiln	Air	Thermal	CHP	
Hitachi Metals	Updraft	Air	Total oxidation		
Hoskinson Group	Tunnel	Air	Total oxidation	CHP	
ICM	Auger kiln Updraft	Air	Total oxidation	CHP	
IES	Auger kiln	Air	Total oxidation	CHP	Defunct in 2017
InEnTEC	Updraft	Air or O <sub>2</sub>	Total oxidation		
Ineos Bio	Grate	O <sub>2</sub>	Thermal	Synthesis	
JFE	Updraft	Air	Total oxidation		
JFE	Tunnel, indirect/direct		Thermal		<i>Fka Thermoselect process</i>
Kawazaki	Shaft	Air or O <sub>2</sub>	Total oxidation		
Mitsubishi	Kiln		Total oxidation		<i>Fka Siemens Schwelbrenn process</i>
Mitsui	Kiln	Air	Total oxidation	CHP	
Neat	<i>See Syngas Products</i>				
Nexterra	Updraft	Air	Thermal Total oxidation	CHP	
Nippon steel	Updraft	Air	Total oxidation		
PHG Energy	Downdraft	Air	Total oxidation	CHP	MaxWest Environmental
Plasco	Grate	Air	Thermal plasma	CHP	
Premier Green Energy	Indirect kiln	Air		CHP	
PRME	Updraft	Air			
Scanarc	Updraft	Air or O <sub>2</sub>	Thermal plasma		
Sierra Energy	Shaft updraft	O <sub>2</sub>		FT, H <sub>2</sub>	
Solena	Updraft (shaft)	O <sub>2</sub>	Thermal plasma	Synthesis	<i>Fka Westinghouse</i>
Syngas Products	Indirect drum pyrolysis	Steam/O <sub>2</sub>	Filter, scrubbing (NaOH NaClO)	ICE	<i>Fka NEAT</i>
Takuma	Kiln	Air	Total oxidation		
W2E	Kiln	Air		CHP	

In a circulating fluidized bed, the density is high at the bottom where the bed material from both internal and external circulation flows in, approaching the bed density of a stationary fluidized bed using the same bed material. However, due to the transport to the wall the density continuously decreases with bed height as solids are transported to the wall, establishing a density profile which depends on the material inventory in the system and the gas velocity. Despite that the density decreases towards the gasifier outlet, even at the outlet, the suspension density is typically an order of magnitude larger than the gas density due to the solids remaining in the gas at the outlet.

The vigorous movement of the bed material in direct gasifiers, and in combination with the large circulation of bed materials in an indirect gasifier, gives a high internal heat transfer rate that assists in maintaining an even temperature in the entire bed, or in the entire reactor in the case of a circulating bed, to avoid hot spots, thereby avoiding or restricting agglomeration.

This movement, however, causes abrasion of friable material such that together with fuel fines, carbon-containing particles are carried out of the reactor with the gas; as a consequence, the carbon content of the fly ash is typically significant.

Even if the fuel is fed to a hotter environment than is the case for a fixed bed, the temperature is not enough to completely decompose tars. The raw product gas typically contains tar in a magnitude of 5-20 g/Nm<sup>3</sup>. Also, in this case, the tar content is higher, and the composition of the tar is more complex when waste fuels are fed, compared to when pure lignocellulosic material is used as a fuel. Inorganics that are volatile will go out with the gas and have to be separated as fly ash or in separate cleaning steps.

Material that is aerodynamically too large to be suspended in this way sinks to the bottom and can accumulate on the oxidant distributor, causing overheating and flow maldistribution that ultimately causes defluidisation and shut-down. The same phenomena can also occur if inorganic constituents of the fuel interact with the bed to make the bed material particles become sticky and glue together to form agglomerates. For this reason, fluidized bed gasifiers are operated at temperatures not higher than 850-950 °C, at most and the highest temperature also applies to the combustion section of indirect gasifiers.

It is also important that the bottom ash is drained at a rate that any such larger particles or agglomerates are removed before any accumulation occurs. By sieving, bed material of the right size fraction can be recovered and recycled. Since volatile inorganic components (sodium, potassium, zinc, mercury, cadmium, etc.) are evaporated in the gasifier and leave the gasifier with the gas produced, the bottom ash typically contains fewer problematic components and is similar to waste incinerator ash in properties and handling.

Direct fluidized beds can be built at large scale. The largest biomass CFB gasifier in operation at atmospheric pressure, at Vaskiluodon Voima in Vaasa, Finland, has a capacity of 140 MW thermal<sup>170</sup>, but CFB boilers are available at even higher thermal capacities. They can also be pressurized up to 1-3 MPa to increase the single vessel capacity further.

Allothermal, or indirect, fluidized beds (i.e. that use a gasifier-combustor combination, e.g. Milena, FICFB and Batelle designs) can have different combinations of fluidization types in the two beds, such as two stationary fluidized bed reactors, one stationary fluidized bed gasifier and circulating bed combustor, one circulating fluidized bed gasifier and one stationary bed combustor or two circulating fluidized beds. Indirect double fluidized beds function in the same way as a fluidized bed, the difference being that there is no oxidant, instead typically steam is added to the gasifier, since

---

<sup>170</sup> [www.power-technology.com/projects/vaasa-plant/](http://www.power-technology.com/projects/vaasa-plant/)

the energy required is instead provided by hot sand bed material being transferred at high rate from the second, combustor bed.

After releasing heat in the gasifier, the sand is returned to the combustor from the bottom of the gasifier and where entrained carbonaceous char material from the gasifier and other fuels are combusted with air to generate the temperature required to re-heat the massive flow of sand. The sand circulation rate (i.e. sand circulation mass/fuel feeding) is defined by the energy balance of the gasifier/combustor system (the gasifier energy requirement resulting from the operating temperature and fuel energy content, moisture, fixed carbon content setting the gasifier energy requirement and the combustor operating temperature which together with the heat capacity of the bed material and the gasifier temperature defines the heat transferred per mass unit of bed material), the magnitude being in the range 20-80 kg of sand per kg of fuel. Since the combustor is subjected to the same limitations on operating temperature as other fluidized beds to avoid agglomeration, the gasifier is operated at slightly lower temperature, compared to when air or oxygen is used directly, to have a temperature difference that matches the sand flow. The heated sand is returned to the gasifier via a bed overflow in the case of a stationary fluidized bed combustor, or via the primary separator for circulating fluidized beds.

The sand circulation loops are also arranged such that beds of sand provide sealing between the gasifier and the combustor to avoid air or gas intrusion into the gasifier and combustor section, respectively. The need for a close-coupled circulation loop in practice restricts the capacity of such reactors from layout limitations to somewhere above 50 MW thermal (as an example, the GoBiGas gasifier has 30 MW thermal capacity). Due to that these seals operate with relatively small pressure differentials, pressurizing such units become very challenging. The main advantage of these systems is that a medium calorific value (MCV) gas can be produced without the recourse to the use of oxygen.

Other forms of indirect fluidized bed gasifiers use indirect heat transfer into the bed via heat exchanger tube bundles immersed in the bed using flue gases from combustion of part of the product gas outside of the gasifier section, or so-called heat pipes immersed in the bed that work as an intermediate heat transfer unit (based on the evaporation and condensation of a liquid, e.g. molten sodium, inside the inclined heat pipe such that liquids are returned to the evaporation section without the use of a pump) in the form of closed heat pipes between the combustor or the gasifier.

The advantages of indirect gasifiers relate to that for synthesis gas the use of oxygen can be avoided, that for some designs total conversion of the fuel can be achieved and by-products disposed of in the combustion section and in the production of a (nearly) N<sub>2</sub>-free, higher heating value gas. There are also drawbacks of indirect gasifiers: the content of tar is higher than for a normal fluidized bed, both because of the lower operating temperature and because the gas is not diluted by the oxidation products and nitrogen. Also, for a synthesis gas to be used for other products than methane, the high content of other hydrocarbons is a disadvantage. When operating an indirect gasifier on waste fuels, the generation of two different gas streams (product gas and flue gas) adds to the system complexity as both the fuel gas and the combustor off-gas must be cleaned to meet user and emission criteria, respectively. Nevertheless, there are some developments based on indirect dual bed gasifiers in the waste area.

The feedstock fuel for fluidized bed gasifiers of all kinds must have properties i.e. particle size and density such that is kept floating in the dense bed formed by the sand-gas mixture, i.e. the entire bed in the case of stationary fluidized beds, or in the denser, bottom section in the case of circulating fluidized beds. Fines present in the fuel are entrained in the gas and leaves the bed but can to some degree be recovered and recycled in the cyclones typically being used as primary

separators for fluidized beds. For use with waste fuels, the limitations on the physical and chemicals (ash) properties of the feedstock for use in fluidized beds requires pre-treatment of the wastes to at least some RDF quality by as removal of glass, metals and other large inorganic objects, and crushing to a suitable size.

The bottom ash is more similar to the bottom ash of an incinerator and can be recycled as e.g. construction material, whereas the gasification section fly ash will, apart from its content of carbon, also have adsorbed PAH compounds from the tar and devolatilized metals from the bed, thus requiring some form of post-treatment prior to disposal<sup>171</sup>. The double-bed indirect gasifiers and plasma gasifiers integrate this post-treatment as a part of the process whereas other types of gasifiers need to address this by other means.

Waste gasification systems based on fluidized bed reactors are summarized in Table 11.

**Table 11 Developers of fluidized bed gasifiers**

Fluidized bed waste gasifiers					
Developer	Type	Oxidant	Gas cleaning	Use of gas	Comments
Sumitomo Foster Wheeler	CFB	Air	Total oxidation	Fuel gas	
EBARA	Internal CFB	Air O <sub>2</sub>	Total oxidation Thermal	CHP Synthesis	EUP Kobe
ECN part of TNO	Indirect CFB/BFB	Indirect	OLGA tar removal (product gas)		Royal Dahlman licensee
Enerkem	Stationary	Air	Thermal+ other	Synthesis	
Envirotherm	CFB	Air	None	Fuel gas, CHP	<i>fka</i> Lurgi CFB gasifier
Frontline Bioenergy	Stationary	Air/O <sub>2</sub>	Thermal	CHP	
GREG	Indirect BFB/CFB	Indirect			TU Vienna technology
HOST	CFB	Air	Total oxidation OLGA tar removal	CHP	
Kaidi	Indirect CFB/CFB	Indirect			<i>Fka</i> Batelle process or SilvaGas process
Kobelco	Stationary	Air or O <sub>2</sub>	Total oxidation Thermal (Plasma)	CHP	Cooperation w. CHOPEX/Europlasma
LLT	CFB	Air	Total oxidation Thermal	Fuel gas CHP	<i>Fka</i> TPS process
Mitsubishi	Stationary	Air	Total oxidation	CHP	
Outotec	Stationary	Air or O <sub>2</sub>	Thermal (plasma)	CHP Synthesis	Cooperation with APP
Aichernig Engineering <i>fka</i> Repotec	Indirect BFB/CFB	Indirect			TU Vienna technology
Taylor Bioenergy	Indirect CFB/CFB	Indirect	Thermal/Catalytic	CHP/GT	<i>Fka</i> Batelle process
TKK	Stationary	O <sub>2</sub>	Thermal		HTW process
Torftech	Special	Indirect			
TRI	Indirect stationary	Steam	Thermal	Synthesis	
Valmet	CFB	Air	None filter	Fuel gas CHP	

<sup>171</sup> Thermal treatment of solid residues from WtE units: A review. D. Lindberg, C. Molin and M. Hupa. Waste Management Volume 37, March 2015, Pages 82-94

### 5.2.5. Entrained flow gasifiers

Most entrained flow gasifiers, see Figure 26, are analogous to the combustion of a solid or liquid fuel or slurry in a burner firing into a combustion chamber. For this reason, the fuel must either be a pumpable liquid that can be dispersed to droplets in the burner nozzle or small particles (< 1 mm) that can be consistently fed by means of dense phase transport to the fuel register of the burner.

Entrained flow gasifier also typically operates in an ash melting mode, i.e. the ash is removed as slag in the bottom of the reactor. This requires operation at very high temperature, e.g. 1 500 °C, to reduce the slag viscosity and make it free-flowing to avoid build-up of slag in the reactor. The refractory lining of the gasifier should however not be exposed to molten slag. Instead, a protecting layer of solid slag should be formed at the slightly lower temperatures of the wall. This is sometimes assisted by cooling the reactor or parts of it. To reach such high temperatures with low energy content fuels and still retain a significant heating value in the product gas is not possible with air, it requires the use of oxygen mixed with steam.

At these high temperatures, the conversion of the small fuel particles or droplets occurs within a matter of seconds, while tars and other hydrocarbons are more or less completely decomposed by various reactions.

Entrained flow gasifiers are typically pressurized up to 1-3 MPa for solids or even more for some high-energy liquids. The high gas velocity and short reaction time at pressure makes it possible to scale this type of technology to large capacities, up to 400 MW or more. However, the complexity of fuel preparation in the case of solids, and the requirement of using oxygen typically does not make small installations feasible, as evidenced by Table 12 and Section 7.3.2.6, where there is only one supplier of entrained-flow gasification processes applied to wastes, and in this case only used for a relatively high energy content liquid wastes.

When using waste materials, there is a strict requirement on the feedstocks, such that the use of high or moderate energy content liquids is feasible (waste oils), while the fuel preparation for solid wastes is feasible for e.g. plastic wastes but not wastes in general.

One advantage of this gasifier type is the ash melting which yields a dense slag by-product with less leaching rate. Since many lighter inorganic species and heavy metals are evaporated at the high temperatures in the gasifier, such dense slag may even be recycled as construction material.

There are also other forms of entrained flow gasifiers where fuel is injected into a gasifier or pyrolyzer and the resulting gas and char solids are blown as a suspension through several heated tubes, Figure 29 top left, where tars etc. are decomposed, which can be seen as a post-treatment of a gas from a pyrolyzer or some other gasifier type. The tubes are then indirectly heated by firing product gas and/or char to heat the tubes by radiation and convection.

From the process descriptions in Sections 6 and 7 one can note that also a type of "entrained flow" post-treatment of the gasifier raw product gas is quite common as a mean to reduce the tar content from the gasifier itself. Such devices can be air- or oxygen-blown and sometimes are assisted by a plasma generator.

**Table 12 Developers of entrained flow waste gasifiers**

Entrained flow waste gasifiers					
Developer	Type	Oxidant	Gas cleaning	Use of gas	
Envirotherm	Liquid feed	O <sub>2</sub>		Synthesis+IGCC	fka Lurgi process

### 5.2.6. Other types of gasifiers

There are also other forms of gasifiers that have or are still being developed. One type is the molten bath gasifier, see Figure 27, where the gasification takes place in a molten salt or metal bath that serves as a heat transfer fluid but can also absorb inorganics and separate out ash into the bath or as a separate slag. The bath uses an air or oxygen “blast” as in a blast furnace for steel making. The energy can also partially come from a plasma generator or from electrodes to partially assist in reaching the temperatures required.

Plasma gasifiers are often mentioned in conjunction with waste gasification. A plasma gasifier is not a generic gasifier type in itself. The plasma generator is instead a mean of providing energy at high temperature (several thousands of °C) to the gasifier, or a post-treatment reactor. The plasma is generated by ionizing a carrier gas (typically gases associated with gasification such as air, nitrogen, argon, carbon dioxide, and steam) to a plasma in an electric arc. The grounding of the arc can be a conducting molten bath (“direct plasma” or “transferred plasma”) within the gasifier reactor or a counter-electrode within the plasma generator itself (“indirect plasma” or “non-transferred plasma”). Plasma gasifiers, where the actual plasma is applied in the gasifier, are moving beds or molten bath gasifiers. There are also several examples where the plasma has been or is applied for post-treatment of the gasifier product gas.

Another application of plasma generators in thermal waste treatment is stand-alone units for melting ash (both from incinerators and gasifiers as well as from other sources) and other inorganic wastes and by-products (e.g. asbestos wastes) to a vitrified slag. This is frequently used in e.g. Japan, and also to process different forms of hazardous wastes. This is however a separate sub-process and not linked to the process of waste gasification process *per se*.

Table 13 gives an overview of commercial developments of molten bath gasifiers.

**Table 13 Developers of other types of waste gasifiers**

Other waste gasifiers					
Developer	Type	Oxidant	Gas cleaning	Use of gas	Process
Diversified Energy	Dual molten bath	O <sub>2</sub> +steam		Synthesis, H <sub>2</sub>	Hydromax
InEnTech	Direct plasma molten bath	O <sub>2</sub>	Thermal	Synthesis, H <sub>2</sub>	PEM
Pyrogenesis	Direct plasma molten bath	Air or O <sub>2</sub>	Thermal, plasma	CHP, Synthesis	PRRS
Ze-Gen (Defunct)	Molten bath	O <sub>2</sub>		CHP, Synthesis	

## 6. Gas cleaning and the use of the product gas

### 6.1. CONTAMINANTS AND EMISSION PRECURSORS

To give an example of the extent of gas cleaning that is required from regulatory consideration for a waste incinerator, the IED LEV values, see Appendix 2 Table A2.1, are used as an example (as can be seen from Appendix 2, Table A2.9, LEV values in USA and the typical client demand in Japan does not differ significantly from the IED values). Since the IED defines combustion, gasification and pyrolysis installations for waste as “incinerators”, the same emission restrictions apply.

Table 14 indicates the level of clean-up required to meet the by limiting emission values (LEVs) in the stack flue gas. The substances defined by the IED as harmful to the environment and hence regulated by limiting emission values (LEVs) in the stack flue gas are defined by the first column in Table 14. An approximate estimate to an air-blown gasifier fuel gas conditions gives the acceptable content in the second column (indirect and oxygen blown gasifiers will typically have less gas yield

by avoiding the nitrogen dilution from air, and hence the concentrations can be somewhat higher). The third column translates the second column into the acceptable content in the fuel which would not require any gas clean-up. The fourth column summarizes the typical contaminant content of waste fuels from Table 1 and Table 2, which in the last column is translated to an approximate clean-up fraction required. Typically, clean-up requirements are of the order of >90 %.

**Table 14 IED emission levels and associated cleaning requirements for wastes**

Contaminant	IED LEV (basis dry flue gas @ 11% O <sub>2</sub> ) mg/Nm <sup>3</sup>	IED LEV Approx. equivalent in fuel gas mg/Nm <sup>3</sup>	IED LEV Approx. equivalent content in waste fuel	Typical contaminant level in MSW/RDF, Table 1 & Table 2	Indicative magnitude of separation or cleaning required, %
Particulates	10	60	n.a.	n.a.	n.a.
N (NO <sub>x</sub> , HCN + NH <sub>3</sub> )	200 (NO <sub>2</sub> )	400 (NH <sub>3</sub> )	< 0.08 % N	0.1-2.2 %	> 90
S (SO <sub>2</sub> , H <sub>2</sub> S + COS)	50 (SO <sub>2</sub> )	150 (H <sub>2</sub> S)	< 0.03 % S	0.1-1 %	> 90
Cl (HCl)	10	60	0.02 % Cl	0.03-2.6	> 95
HF	1	6	12 mg/kg F	35-100 mg/kg	> 95
Hg	0.05	0.3	0.6 mg/kg	0.05-5 mg/kg	> 50
Cd+ TI	Σ 0.05	Σ 0.3	Σ 0.6 mg/kg	Σ 0.3-16	> 90
Sb, As, Pb, Cr, Co, Cu, Mn, Ni and V	Σ 0.5	Σ 3	Σ 6 mg/kg	Σ 300-1000 mg/kg	> 99
TOC	10	60	n.a.	n.a.	n.a.
CO	50	300	n.a.	n.a.	n.a.
Dioxin, furans	0.0001	0.0006	n.a.	n.a.	n.a.

Also, for other applications, the required contaminant removal prior to the use of the gas in prime movers, fuels cells and for synthesis is also high, see Table 15. In fact, when comparing the second column in Table 14 with the data in Table 15, it is clear that at least for sulphur halides and in many cases also for fixed nitrogen species, the gas cleaning requirements are even stricter than for an waste incinerator.

**Table 15 Selection of data on gas cleaning requirements<sup>178, 172, 173, 174, 175</sup>**

Applications	Gas engine	Gas turbine	Fuel cell	FT synthesis	Methanol synthesis
<b>Contaminants</b>					
Particles (mg/Nm <sup>3</sup> )	< 50	< 10	< 0.1	< 0-0.1	< 1
Tar (mg/Nm <sup>3</sup> )	< 50	< 10	n.a.	0.1-1	< 1
Sulphur species (ppmv)	< 20-50	< 20	< 1 SOFC < 0.06-10 PAFC < 50 MC < 0.5	< 1-0.01	< 1-0.1
Nitrogen species (ppmv)	< 80	< 50**	Not limited	< 1- 0.02	< 0.1-10
Alkali species (ppmv)	< 0.025-0.1	< 0.025-0.1		< 0.01	n.a.
Halides (Cl+F+Br) (ppmv)	< 100	< 1	< 1	< 0.01	< 0.01-0.1
* In vapor phase, and below dew point in process.					
** Emission limited					

<sup>172</sup> An overview of advances in biomass gasification. Vineet Singh Sikar et al. Energy Environ. Sci., 2016, 9, 2939

<sup>173</sup> Fuel Gas Technology for Biomass and Waste. Environmental and Techno-Economic Assessments. Fabrizio Di Gregorio, Dissertation. Department of Environmental Sciences. Second University of Naples, Italy, 2012

<sup>174</sup> On the gasification of biomass in a steam-oxygen blown CFB gasifier with the focus on gas quality upgrading: technology background, experiments and mathematical modelling. Marcin Siedlecki. Dissertation TU Delft, the Netherlands, 2011.

<sup>175</sup> In bed and downstream hot gas desulphurization during solid fuel gasification: A review. Meng, X., De Jong, W., Pal, R., Verkooijen, A.H.M. Fuel Processing Technology, 91(8), 964-981.



## 6.2. GAS CLEANING TECHNOLOGIES

The intention of this section is to give some insight into this subject and not to cover it in a comprehensive way, as this can be found in several sources, such as reports<sup>176, 177, 178, 179, 180, 181, 182, 183</sup> and other publications and books<sup>184, 185</sup>. The gas cleaning technology and equipment used does not differ in many cases from what is used in waste incinerators or other industries e.g. refineries and fossil gasification plants.

By comparison, in a conventional waste incineration plant, the contaminants contained in the fuel are transferred to the flue gas and have to be eliminated by the post-combustion flue gas cleaning system. The treatment processes have evolved over time to a limited number of more or less common configurations, the three most common being shown in Figure 30. This is an entirely commercial cleaning technology for which there is industrial experience among suppliers from many installations over extended periods.

---

<sup>176</sup> Report on Gas Cleaning for Synthesis Applications. Work Package 2E: "Gas treatment". Intelligent Energy for Europe project ThermalNet. Deliverable: 2E-3. H. Hofbauer, R. Rauch and K. Ripfel-Nitsche. October 2007

<sup>177</sup> Near zero emission advanced fluidised bed gasification (Flexgas). Research Fund for Coal and Steel. Contract No RFCR-CT-2007-00005. Final Report. DG RTD 2012.

<sup>178</sup> Gasification of Non-woody Biomass Economic and Technical Perspectives of Chlorine and Sulphur Removal from Product Gas (Non-confidential version). S.V.B. van Paasen, M.K. Cieplik, N.P. Phokawat. ECN-C-06-032. ECN, the Netherlands, 2006.

<sup>179</sup> Waste-to-clean-syngas by avoiding tar problems. A. Bosmans, S. Wasan and L. Helsen. 2nd International Enhanced Landfill Mining Symposium, Houthalen-Helchteren, October 14-16, 2013

<sup>180</sup> Waste Gasification by Thermal Plasma: A Review. F. Fabry, C. Rehmet, V-J. Rohani, L. Fulcheri. Waste and Biomass Valorization, 2013, 4 (3), pp.421-439.

<sup>181</sup> Gas cleaning downstream biomass gasification. Status Report 2009. R.W.R. Zwart. ECN-E--08-078. ECN, the Netherlands, June 2009.

<sup>182</sup> A review of cleaning technologies for biomass-derived syngas. Patrick J. Woolcock, Robert C. Brown. Biomass and Bioenergy 52 (2013) 54-84

<sup>183</sup> Stevens, D.J., Hot Gas conditioning: Recent Progress with Larger-Scale Biomass Gasification Systems, 2001, Report by IEA Biomass Task 33 Thermal Gasification of Biomass

<sup>184</sup> Handbook biomass gasification. Ed. H.A.M. Knoef. BTG World. 1 ed. 2005, 2nd ed. 2009.

<sup>185</sup> Gas Production, 3. Gas Treating. Boll, W., Hochgesand, G., Higman, C., Supp, E., Kalteier, P., Müller, W.-D., Kriebel, M., Schlichting, Tanz, H. In Ullmann's Encyclopedia of Industrial Chemistry. Wiley-VCH Verlag GmbH & Co. KGaA, Weinheim, Germany, 2011.

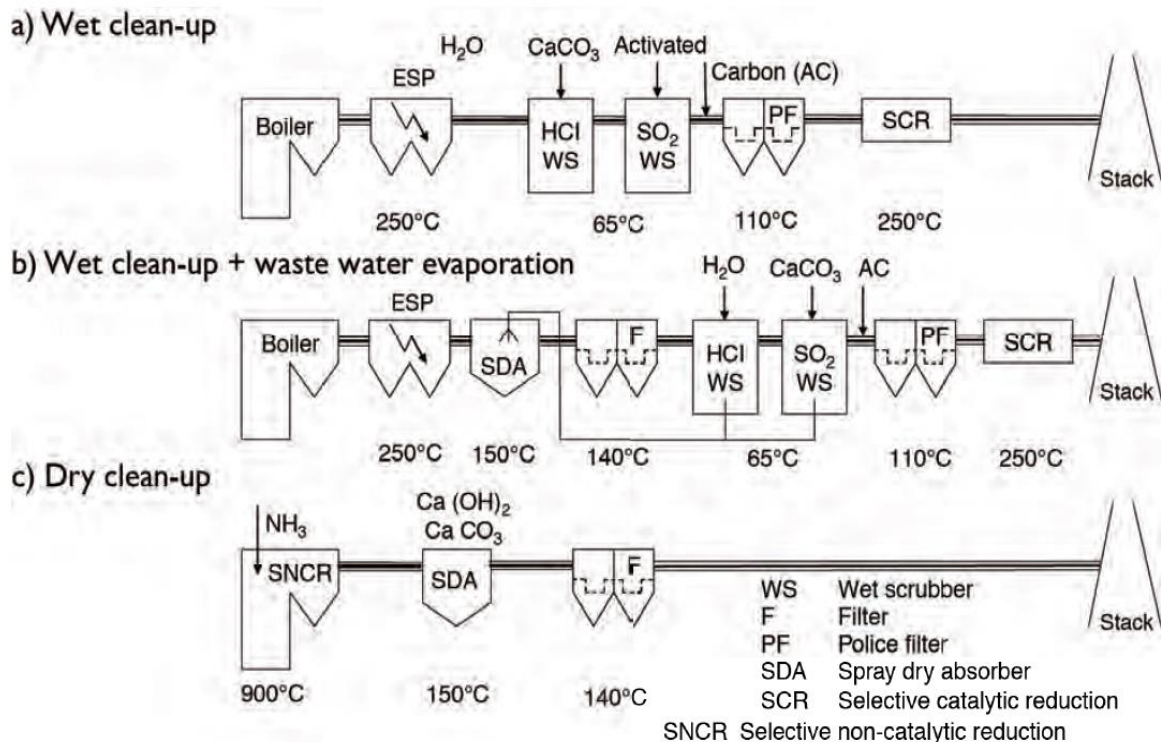

**Figure 30 Common configurations for incinerator flue gas cleaning<sup>186</sup>**

For a gasification or pyrolysis plant utilizing wastes, depending of the use of the gas and the ease of cleaning, there is a choice of pre-combustion cleaning and post-combustion cleaning or combinations of these, that meet both the application and the emission requirements, see Figure 31.

The gas cleaning after waste gasifiers and pyrolysers, with the exception of post-combustion cleaning, is less developed than for the flue gas resulting from an incinerator and there has been relatively few commercial installations.

Instead, the overwhelming majority of the more than one hundred waste gasification plants in operation or in construction/planning is therefore relying on total oxidation, i.e. close-coupled burning the gas directly after the gasifier, and prior to any cleaning of the fuel gas generated in the gasifier. Such installations recover energy from the flue gases after the combustion and relies entirely on conventional post-combustion cleaning as used after incinerators, as was exemplified in Figure 30.

Although such installations are called gasifiers, since a gaseous intermediate with a measurable heating value is produced in the first stage under sub-stoichiometric conditions, these could equally well (and maybe preferably) be named two-stage incinerators. Even in conventional incinerators, sub-stoichiometric combustion, even if at higher air/fuel ratios than in a gasifier, is often used at the grate level to reduce NO<sub>x</sub> formation even if additional air is then added higher up in the furnace.

In addition, the heat recovery from such a gasifier shares the same limitation in the feasible steam superheat temperature to approximately 450 °C as all particulates and gaseous contaminants are

<sup>186</sup> Gasification Technologies Review – Technology, Resources and Implementation Scenarios. Final Revised Report. Prepared for the City of Sydney’s Advanced Waste Treatment Master Plan. Talent with Energy (TWE) August 2014.

present in the flue gas in the same concentrations as after an incinerator. Therefore, due to the steam superheat limitation, also the performance is similar, or slightly inferior, compared to an incinerator, see Section 7.3.1.

There are also gasifiers that are more or less close-coupled with a kiln or furnace where the gas is combusted, and where there is no gas cleaning with maybe the exception of removal of coarse dust in a cyclone. In such installations, post-combustion flue gas cleaning to the same extent, and similarly to a waste incinerator is required, with the possible exception of cement and lime kilns, respectively, where alkalis, halides and sulphur oxides are trapped in the kiln charge. Even so, there is a limit on how much alkalis and halides that can be tolerated, and hence on the fuel used and/or the share of the overall fuel since both alkalis and halides affect the water resistance of the cement<sup>187</sup>.

Furthermore, for indirect gasifiers, irrespective of the cleaning processes for the gasifier product gas, such post-combustion cleaning processes are also required for the treatment of the flue gas generated in the combustion section of the gasification installation, if a fuel classified as waste is fed to the gasifier section.

There are only a handful plants, see Section 7.3.2 and 7.4 that utilize some sort of pre-combustion cleaning to an extent that the post-combustion cleaning can be partially or completely eliminated. But the pre-combustion cleaning enables the use of cleaned gas for the purpose of generating electric power at higher efficiency than by incineration or two-stage incineration, respectively, or for producing material products.

---

<sup>187</sup> State-of-the art report: Key parameters influencing the alkali aggregate reaction. B.J. Wigum, L. t. Pedersen, B. Grelk, J. Lindgård. PARTNER-project-GRD1-CT-2001-40103. SINTEF Building and Infrastructure, Norway, 2006.

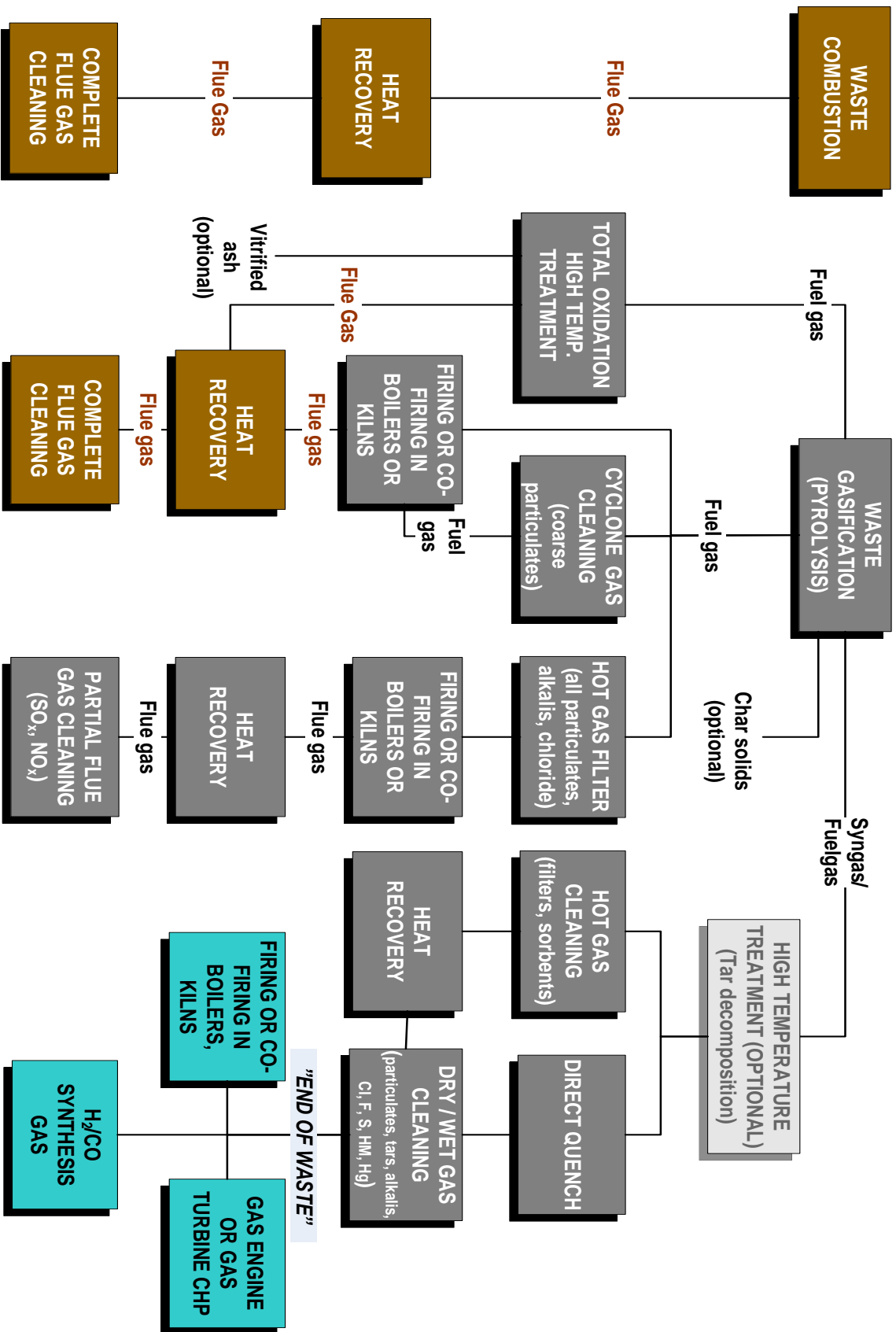

Figure 31 Relation between pre-combustion and post-combustion gas cleaning.

Gas cleaning for waste gasification applications is a complex set of technologies to meet end-use requirements or limiting emission values. Such treatment can be "dry" or "wet", i.e. respectively above or below the water dew point of the gas, or also combinations of dry and wet gas cleaning. Dry cleaning avoids formation of tar liquor or process water condensate. However, even if a number of contaminants can be efficiently eliminated from the gas by dry cleaning, currently there is no technically or economically feasible method yet to achieve sufficient gas quality to completely avoid the use of post-combustion cleaning under dry conditions.

By means of wet cleaning or combinations of dry and wet cleaning, the gas can be purified to a quality where emissions are "similar to those of natural gas", see section 4.3.1, i.e. the gas is no longer a waste (i.e. implying that when the gas is burnt, this installation is not an incinerator even if the gasifier is an incinerator from legal definitions), and furthermore such cleaned product gas can be used for synthesis processes.

It is difficult to make a general description of such a flowsheet, as there are several alternatives for performing the gasification step (each resulting in somewhat different gas characteristics), and there are also many alternatives for each of the cleaning steps used. Furthermore, the process conditions at the inlet and outlet of each such process to some extent defines the upstream and downstream cleaning steps into viable process sequences.

The first steps of product gas cleaning are most often the elimination of the particulates and tar, which is also heavily linked to the possibility for efficient heat recovery from the hot gas. Tars (generic name of the group of hydrocarbons larger than benzene, which are condensable at ambient temperature), which are present in the hot product gas as vapours and/or aerosols, can condense during the cooling of the gas, thus causing heat exchanger fouling, blockage of filters, contamination of scrubber liquids, etc. It may also interfere with other clean-up procedures by "hiding" e.g. nitrogen, chloride or sulphur in the organic structure, thereby making them non-accessible to other gas cleaning procedures. Therefore, the management of tars is an important aspect for all gas cleaning, and in particular for wet cleaning.

Tars can almost be completely decomposed to mainly gaseous species and often also some soot if the gasifier is operated at sufficiently high temperatures ( $> 1\ 200\ ^\circ\text{C}$ ), or if a post-treatment at high temperature ( $> 1\ 000\ ^\circ\text{C}$ ) directly after the gasifier is used, only traces of stable aromatic compounds will remain.

For direct fuel gas applications, the gas temperature can be maintained above the tar dew point, typically  $200\text{--}400\ ^\circ\text{C}$ , up to the burner. Thereby condensation of tars can largely be avoided so that the tars can be managed, even if, overall, this limits the possibility for more extensive gas cleaning. Below the tar condensation point, tar scrubbing combined with other methods to remove aerosols (for example, electrostatic precipitators) can be a possible approach.

Depending on the tar concentration after the gasifier or after any post-treatment of the gas for tar removal, particulates can be removed at high, intermediate or ambient temperature. The removal of halides can be achieved as solids by reaction with alkalis present in the gas or from sorbents added to the gas at intermediate temperatures upstream of particulate removal even in the presence of tar, as long as the gas temperature is above the tar dew point.

A cleaned product gas where particulates, alkalis and halides have been removed can be used without corrosion-related restrictions in steam temperatures that are present in ordinary waste incineration conditions. The gas therefore is compatible with co-firing or for higher efficiency to power (as in e.g. the Kymijärvi II plants, see section 7.3.2.4). If tar scrubbing processes at low temperature are used, these can be combined with particulate removal by direct quenching from

gasifier to ambient temperature or be preceded by particulate removal at intermediate temperatures.

However, and apart from burning the product gas as a fuel in a boiler or kiln, if prime movers, fuel cells and synthesis gas applications are considered, also purification from residual tar, sulphur, nitrogen species, mercury and other heavy metals are required, using sorbents, wash systems and catalysts, and where a prerequisite is that cleaning from tars and particulates has already been performed.

From an overall process integration point of view there are trade-offs between such alternatives. A thermal treatment to remove tar typically uses additional energy in a plasma and/or oxygen injection to raise the temperature to have sufficient tar conversion, i.e. transfers electric or latent combustion energy to sensible heat, thereby reducing the cold gas efficiency. However, such treatment may on the other hand, facilitate a more efficient heat recovery of this sensible heat, whereas direct quenching means that it is only possible to recover the sensible heat in the gas, typically some 15 % of the fuel energy, as low-level heat. Another option is to accept the tar during gas cooling. Downstream, the tars, that may constitute several % of the input fuel energy, if separated from the gas can be recycled to the gasifier and this energy recovered, but also of the dispose of a difficult and hazardous waste product.

### **6.2.1. Particulate removal**

The particle concentration in a gasifier product gas, and the particle morphology, depend on the gasifier type and the fuel characteristics. However, in general, the particle concentration from the gasifier, but after a recycling separator in the case of fluidized beds, can amount from 1 to over 20 g/Nm<sup>3</sup>. Fluidized beds, in particular circulating fluidized beds, are at the upper part of this range. The particulate concentration is to some extent temperature-dependent, since some inorganic and heavy tar species may be in the vapor phase at gasifier conditions but condense as the gas temperature is reduced.

In the case of updraft gasifiers, and also from various forms of pyrolysers, particulates at the outlet are mainly composed of fuel particle fines, such that the carbon content is high and there may still be volatiles present in this dust. At the low exit temperatures of updraft gasifiers, these particles serve as condensation nuclei for the tar aerosols ("tar mist"), such that there is no real distinction between solids and liquid particulates.

In the case of fluidized beds, particles are typically well below 0.2 mm and are composed of small particles of devolatilized fuel, ash particles from fully converted fuel particles, fines emanating from bed material or char attrition in the bed, as well as soot formed by tar cracking. Also, in this case, the carbon content is high (50 wt.% or more). This organic material has a high surface area and can easily ignite in air after being separated from the gas and transferred to a fly ash storage.

Entrained flow gasifiers typically operate above the ash melting point, such that there is a separation of viscous slag at the bottom of the gasifier. The rapid heat up of the fuel also causes some soot formation and the high operating temperature in the gasifier causes devolatilization of some inorganic constituents. However, there is typically a partial or full quench (i.e. reducing the temperature to a more manageable level, above or below the water dew point, respectively) at the gasifier bottom or outlet such that any inorganic material entrained by the gas is solid, and vaporized inorganics return to the solid state. Overall the carbon content in the particles is typically low, and the particulates are mainly composed of solids of a small size, < 0.1 mm.

Table 16 summarizes the available technologies for the dry removal of particulates from product gas. The most common, and also the simplest particulate removal device under "dry" conditions, is

the well-known cyclone, where the gas is tangentially injected into a cylindrical body. The centrifugal forces move particles to the wall, where the particle layer formed slides downwards into a collector or recycle leg, and the gas exits by an axial pipe at the top. Due to limitations in the tangential to 15-25 m/s inlet velocity from pressure drop and erosion considerations, cyclones are efficient in removing relatively coarse particles, and more efficient for heavy particles (bed material, ash) than for light particles (soot, fuel fines). As the cyclone curvature is reduced with volume flow, the efficiency is decreased at higher throughput, and also at hot, relative to cold conditions for the same inlet velocity, since the gas density is reduced, and viscosity increased. In practice, single cyclones can separate particles above 0.01-0.05 mm with high efficiency but have low efficiency for fines below this size. Using multiple parallel small cyclones at hot conditions adds complexity and is rarely used. The characteristics of cyclones make them suitable as a primary separator for fixed beds, and in particular for fluidized beds.

The other means of separating particles under "dry" conditions is to use filters. The most common filters used are the barrier filters (baghouse or candle filters), which are also commonly used in boilers and other applications. These can only be used above the water and tar dew point, as otherwise the condensation on the filter cake interferes with the filter cleaning. These filters are sized based on a so-called face velocity (or flow/filter area), which is in the range of a few cm/s. The filter is composed of several bags or candles that are contained in one or more housings (Figure 32). These are surface filters, i.e. dust is deposited on the filter material as a support for a thin filter cake that gradually increase in thickness. This causes an increase in the pressure drop over the filter, and a cleaning sequence is triggered by a pressure drop limit or timer.

The cleaning of the filter is often accomplished by pulse jet cleaning, i.e. a short pulse of high velocity gas (usually, N<sub>2</sub> or some other inert, oxygen-depleted gas) is injected in the filter bag or candle causing flow reversal through the filter cake, and for cloth filters also a mechanical shaking effect, Figure 32.

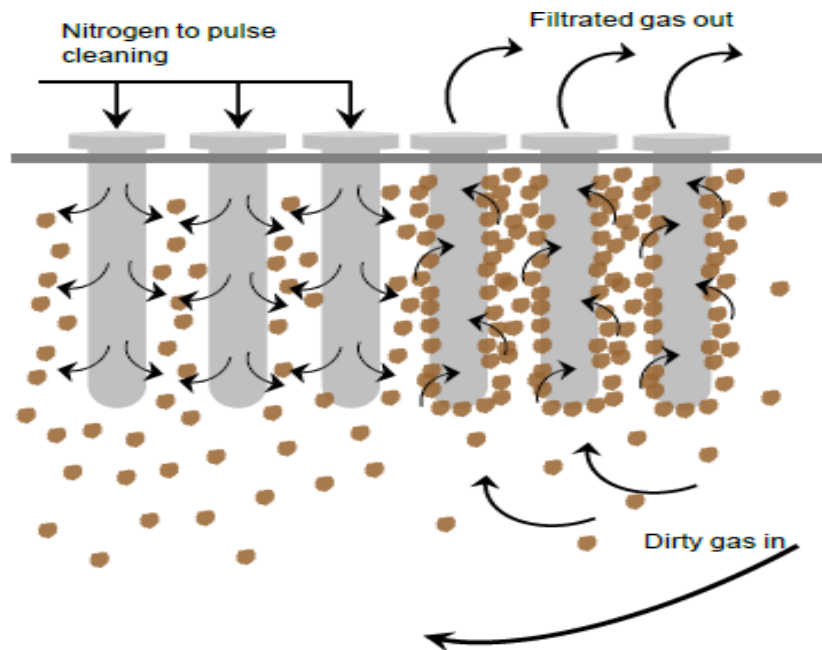

**Figure 32** The principle of pulse jet cleaning<sup>188</sup>

<sup>188</sup> Advanced solutions for Energy from Waste. Frank Ligthart, Valmet, 11 June, 2014

This causes the filter cake to break-up and fall from the filter bag or candle. Pulse jet cleaning can be performed in sections such that pulses are directed to a part of the filters in the housing only, which are cleaned while the other filters are still passing gas in the normal flow direction, thereby allowing cleaning on line.

Another method for filter regeneration is reverse flow, whereby a continuous flow is sent in the reverse direction of flow to all filter units in a filter housing, and by rapping, i.e. a mechanical shaking effect. Reverse flow and rapping are typically performed off-line, which requires at least one additional filter housing to allow continuous operation. In gasifiers, and unlike in boilers, the cleaning gas used cannot be air or oxygen-containing flue gas as the carbon content of a typical fly ash from a gasifier is high and also has a high surface area such that it can ignite in the presence of oxygen and damage the filter.

Filters have in general very high efficiency, close to 100 %, and since the filter cake on the exterior of the filter elements provides additional bed filtration, the efficiency is also very high for small particles, even for particles smaller than the nominal pore size of the filter elements.

Rigid filter candles with a thickness of 2-10 mm are manufactured by sintering shapes made of ceramic or metallic powders in the micron range. The cost of such filter candles is high, and they are therefore mostly used under pressurized conditions, as these conditions allows a higher throughput on a weight basis for the same face velocity and also higher pressure drop (of the order of 5-15 kPa) can be accepted. Depending on the material, such filters could be used at the temperature of the gasifier exit, if materials compatible with the atmosphere are available, but it would also require that process operability (start-up, pre-heating, etc.) and mechanical challenges of the ancillary components (candle-tube sheet seals, tube sheet, cleaning injectors, etc.) in the filter can be overcome. They are commonly used in entrained flow coal gasifiers around 400 °C, and commercial readiness is up to approximately 600 °C at present.

There are also lightweight fibre filters that can tolerate temperatures up to 500 °C and where the costs are much lower than the sintered candles such that these can be used at atmospheric conditions. One notable example is the Kymijärvi II plant, see Section 7.3.2.4. However, long-term experience is still lacking, and the cleaning and maintenance are still issues to address.

The conventional kind of fabric filters used in combustion boilers and made of various natural or polymeric fibres made into cloth or needle-felts, can also be used below the temperature limit for materials such as Nomex (250 °C). As long as the gas is above the tar dew point or other effects are present (e.g. hygroscopic filter cake), such filters are relatively cheap and also very efficient.

Another type of filter that has been studied is granular bed filters, which are depth filters. The contaminated gas flows in counter-current or cross-current through a bed of filter particles made from e.g. sand of a suitable particle size, which move downwards by gravity. The gas moves through the pores of the bed and the particulates get trapped in the particle interstices of the moving bed. The bed is then moved out of the filter zone and regenerated by e.g. sieving to allow collection of the ash and soot particles. Such filters can be used at high temperatures and are relatively efficient, but the low gas velocities used to reduce the pressure drop for small filter granules and the large amount of filter bed material required for filtration has not made them come into commercial use for gas filtration for waste gasification applications. However, one gasification gas cleaning supplier, Dahlman, offers a combined tar conversion and filter combination for gasification purposes<sup>189</sup>. Otherwise, granular bed filters are common in water filtration, and also in nuclear reactors as once-only safety filter for gas releases.

---

<sup>189</sup> [www.royaldahlman.com/renewable/home/tar-removal/tara-technology/](http://www.royaldahlman.com/renewable/home/tar-removal/tara-technology/)



Dry electrostatic precipitators, which are common in e.g. boilers, and which can also be designed for elevated temperatures, are not used in gasifiers since the carbon content in the particulates causes charge transfer between particles, which results in a deterioration of the efficiency.

The energy consumption in dry particulate removal is related to the pressure loss in the gas cleaning device. Assuming that this is low in relation to the absolute pressures such that the gas compressibility can be disregarded, 1 kPa pressure drop corresponds ideally to approximately 0.3 kWh/1 000 m<sup>3</sup>, not considering any fan efficiency.

**Table 16 Dry particle removal systems (adapted from<sup>182</sup>)**

Device	Collection efficiency (%)	Pressure drop (kPa)	Flow capacity (m <sup>3</sup> /m <sup>2</sup> , s)
Cyclone Conventional Enhanced	<i>Part. size, density</i> >90 % > 90–95 %	Low to mod. (2.5-7.5) Mod. to high (7.5-27.5)	Very high Very high
Granular filters Fixed Moving	>99 % >99 %	Moderate (6–10) Moderate	High (0.15-0.2) High
Electrostatic precipitator (ESP)	>99 %	Very low (0.3–0.6)	Low to mod. (0.01-0.03)
Ceramic bags	>99.5 %	Low (1–3.5)	Low to mod. (0.01-0.03)
Rigid barriers filters Ceramic candle Cross-flow Ceramic tube Metallic candle	>99.5 %	Moderate to high (5-25) Low to moderate (2.5-7.5) Moderate (8–12.5) Moderate to high (5–25)	Mod. to high (0.02-0.07) Mod. to high (0.03-0.07) Mod. to high (0.03-0.05) Mod. to high (0.02-0.05)
Bag-house filters	>99.5 %	Low (1–3.5)	Low to mod. (0.01-0.03)

At lower temperature and for “wet” cleaning systems, various forms of scrubbers can be used for particulate removal, as shown in Table 17, e.g. tower scrubbers and Venturi scrubbers.

**Table 17 Wet particle removal systems (adapted from<sup>176</sup>)**  
(note that pressure drop is given in mbar= 0.1 kPa)

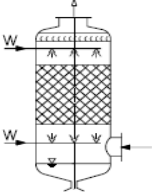
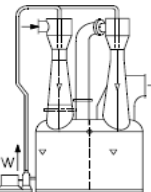
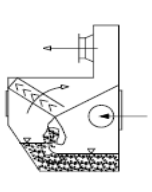
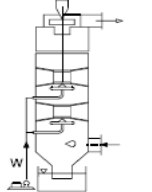
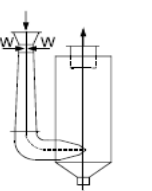
Type	Tower-Scrubber	Jet-Scrubber	Swirl-Scrubber	Rotation-Scrubber	Venturi-Scrubber
					
Separation size in μm for ρ=2.42 g/cm <sup>3</sup>	0,7 – 1,5	0,8 – 0,9	0,6 – 0,9	0,1 – 0,5	0,05 – 0,2
Relative velocity in m/s	1	10 – 25	8 – 20	25 – 70	40 – 150
Pressure drop in mbar	2 – 25	–	15–28	4–10	30–200
Liquid/gas in l/m <sup>3</sup>	0,05 – 5	5 – 20 <sup>a</sup>	-	1 – 3 <sup>a</sup>	0,5 – 5
Energy consumption in kWh/1000 m <sup>3</sup>	0,2 – 1,5	1,2 – 3	1 – 2	2 – 6	1,5 – 6

<sup>a</sup> per stage

Scrubbers can both be the main particle separator or be used as a complement to upstream particle separators and can be designed to capture very small particles.

However, when scrubbers are used for particulate removal, they typically are also designed to remove tar aerosol and/or to absorb of water-soluble contaminants such as HCl and NH<sub>3</sub>. The design principles under gasification conditions are similar to the design principles for other applications.

The energy consumption in a wet scrubber includes both the gas pressure loss (estimated as above) and the washing liquid pumping. The liquid circulation is typically 1 m<sup>3</sup> /1 000 m<sup>3</sup> gas or more at a pressure rise of at least 0.2 MPa, such that typically at least 0.1 kWh/ 1 000 m<sup>3</sup> of gas should be supplied for the pumping in addition to the gas pressure loss energy consumption. However, the grade efficiency for removing small particles (Figure 33) is very dependent on the pressure drop and water usage, such that the energy consumption can be considerably higher, as evidenced in Table 17.

In many cases, the scrubbed gas passes a wet electrostatic precipitator (WESP), which can remove both liquid and solid aerosols to low levels (~ 10 mg/Nm<sup>3</sup>). Since the collector electrodes are flushed with circulating water, even tar aerosols can be managed. WESPs are used in e.g. coke oven plants.

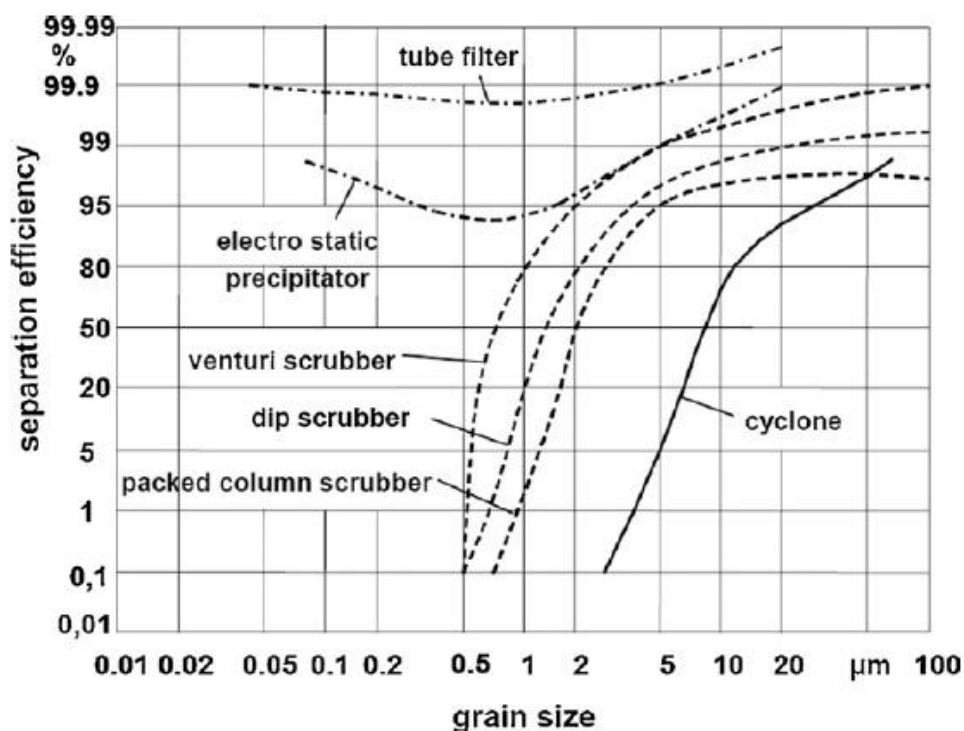

**Figure 33 Particulate removal devices grade efficiency<sup>190</sup>**

### 6.2.2. Tar removal

Tar is a complex mixture of hydrocarbons containing a wide range of aromatic and polyaromatic substances (PAHs). Tars are formed as the fuel organic structure is decomposed during the pyrolysis step and then undergo secondary and tertiary reactions in the vapor phase such that the originally

<sup>190</sup> Tar reduction in biomass producer gas via mechanical, catalytic and thermal methods: A review. Samsudin Anis, Z.A.Zainal. Renewable and Sustainable Energy Reviews 15 (2011) 2355-2377.

formed, oxygenated compounds, are gradually with time and temperature deoxygenated to an increasingly aromatic composition, see Figure 34. Tar is typically a hazardous material due to its content of PAH and lighter aromatics such as benzene, toluene and xylene (BTX), all of them carcinogenic compounds. Tars generated by waste gasifiers where chlorinated and other halide aromatics can be present to a larger extent than for other fuels due to plastics of various compositions in the feed material is further adds to the hazardous characteristic.

BTX and tars can be present as vapours in total quantities from below 1 up to 10 % by weight or more in the gas exiting the gasifier, depending on the gasifier design, see Section 5.2. Tars condense when the gas is cooled to form a liquid/semisolid substance that fouls the system and contaminates process condensate (if tar and water are jointly removed). Figure 35 schematically shows the development of the tar dew point.

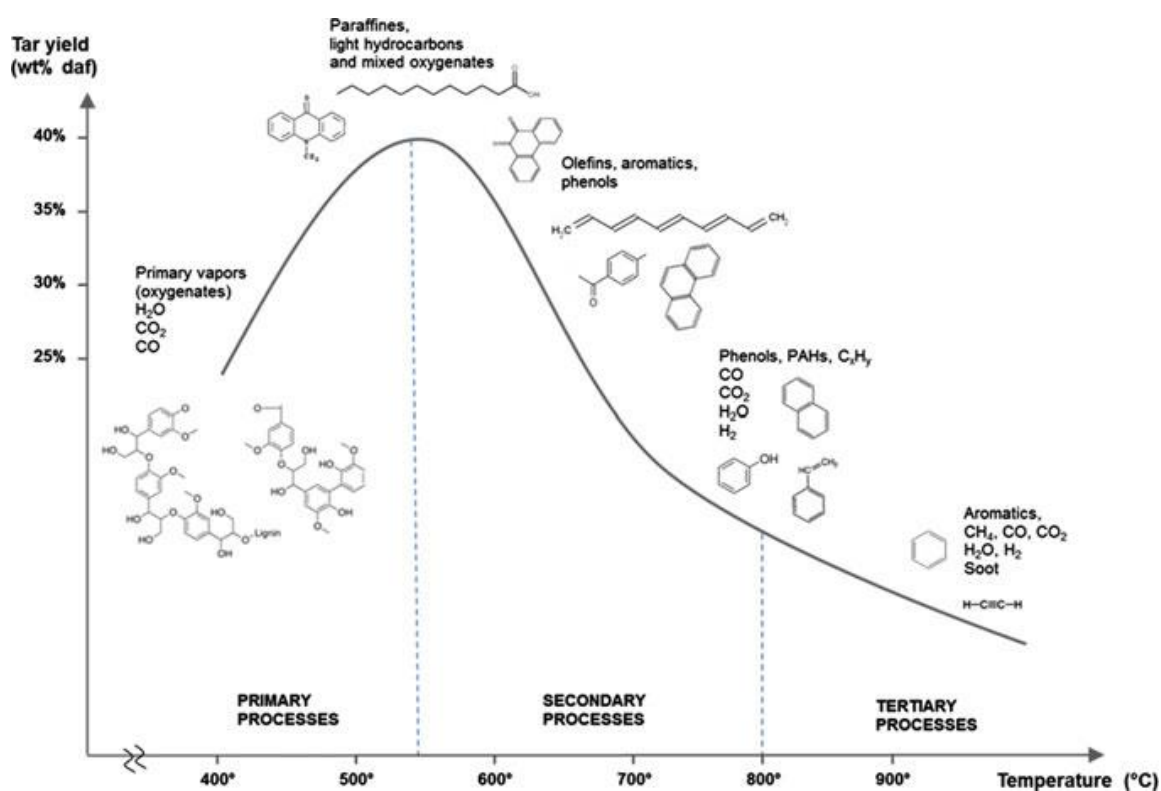

**Figure 34** Tar yields (wt.% dry ash-free (daf)) and main component types for a lignin-plastic mixture in a generic gasification process, as representative for waste material as a function of temperature.<sup>191</sup>

Initially, and coinciding with a high level of tar formation, the tar dew point is low. As temperature increases, the tar dew point firstly decreases as the total amount of tar decreases. However, there is typically a maximum in the tar dew point, as at higher temperatures, despite a lower total amount of tars, these are mainly composed of heavy PAHs, which dramatically influence the tar dew point. There is a web-site model developed by ECN, part of TNO, available to estimate the tar dew point<sup>192</sup>.

To manage the presence of tars in the product gas from waste gasification in the gasifier itself or in downstream process stages, four methods have been applied or are being developed: catalytic

<sup>191</sup> Clean Energy from Waste Fundamental Investigations on Ashes and Tar Behaviours in a Two Stage Fluid Bed-Plasma Process for Waste Gasification. Massimiliano Materazzi. Thesis, University College London, UK. Springer International Publishing AG 2017  
<sup>192</sup> www.thersites.nl

decomposition, thermal decomposition physical separation of the tar, and temperature control to keep the tar in the gas phase up to the gas end-use point in a burner. There are a number of reviews<sup>190, 193</sup> on this subject covering biomass gasification in addition to the general gas cleaning literature already referred to above.

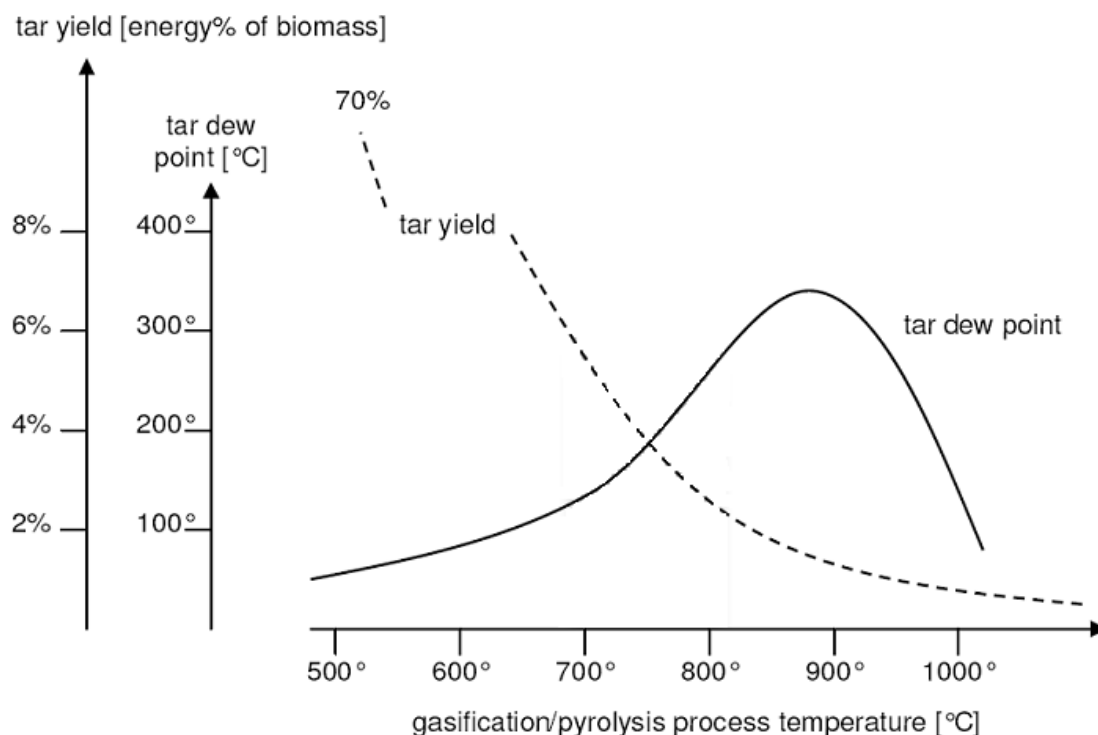

**Figure 35** The relation between tar formation for wood and the tar dew point (Adapted from<sup>194</sup>).

#### 6.2.2.1. Catalytic tar conversion

The first method tries to convert tar into lower molecular weight gases by catalytic conversion at high temperature, more or less directly inside, or in a separate stage downstream of the gasifier.

The use of catalysts integrated into the gasification zone of a reactor, fed separately or fed mixed in with the fuel, is only readily applicable to fluidized beds due to the good mixing conditions. In a fixed bed the zoning of the reactions and temperatures and the limited solids and gas mixing would make the use of catalysts inefficient, while for entrained flow gasifiers the residence time of the gas is low temperature is so high that other limitations for the use of a tar decomposition catalyst are present. The catalyst particle size and, very importantly, its attrition resistance must then be compatible with this type of system. However, since devolatilization of the fuel is occurring in large parts of the reactor volume while the solids are concentrated in the bottom of the bed, the contact between tar and catalyst is a limiting factor. Furthermore, the temperature within the gasifier may not be optimal for tar conversion, as also other aspects such as e.g. bed agglomeration must be considered in selecting the operating temperature. Such catalysts are eventually in the end mixed with the bottom or fly ash, depending on their particle size, so it should be recoverable for re-use if it is expensive. In addition, the active catalyst component should be acceptable from an ash

<sup>193</sup> The reduction and control technology of tar during biomass gasification/pyrolysis: An overview. Jun Han, Heejoon Kim. Renewable and Sustainable Energy Reviews. 12 (2008) 397-416

<sup>194</sup> Tar removal from low-temperature gasifiers. Robin Zwart et al. ERA-NET Bioenergy project "Tar removal from low-temperature gasifiers". Report ECN-E--10-008. ECN 2010

disposal point of view, i.e. not adding e.g. toxic metals to an already problematic waste product.

For biomass gasification, see references in the introduction to Section 6, and to a lesser degree there has been an active search for such materials that have a significant catalytic effect on tars, but no such material that simultaneously has a major impact on tars while also meeting other boundary conditions have been found and is in use. Nevertheless, catalytically active material that has a marginal impact on the global tar concentration but reduces e.g. the heavy tar fraction may still have a significant impact for the entire plant. In the area of biomass gasification, the GoBiGas plant<sup>195</sup> initially suffered from tar issues but the operational team learned to control the heavy tar by using alkali addition to activate the bed material and reduce the heavy tar. This procedure opened up for more continuous operation.

In principle, it could be possible to include catalyst as a separate stage inside a gasifier, but this approach does not seem to have been explored for waste gasification. If a separate reactor is used downstream of the gasifier, this adds to cost and complexity but the contact between the catalyst and the gas is improved and both the operating conditions and the form of the catalyst (fluidized bed, fixed bed, monolith) can be chosen more freely.

Even if catalytic cleaning is being developed and piloted for biomass gasification in numerous projects and in at least one commercial plant, in the case of waste gasification, the use of manufactured tar reforming catalysts based on e.g. nickel is extremely challenging, in view of the presence of tars, particulates and a number of other gaseous contaminants. Sulphur, halides, alkalis and other metal compounds in the vapor phase are known to interact chemically or physically with catalysts and such contaminants are typically present in higher concentrations in the gas from waste gasification than from biomass gasification. At best, it can be seen as a very long-term possibility and as far as has been found in this study there is no ongoing development in this direction for waste gasification at an industrial scale.

Another approach involves the use of natural, relatively cheap minerals such as dolomite and olivine, materials which exhibit some catalytic properties for tar decomposition. This has been widely explored<sup>196</sup> both as an in-bed catalyst for fluidized beds and as secondary tar removal system in biomass gasification processes but this approach has not been used for waste gasification at large scale. Taylor Biomass Energy, see Section 7.3.2.10, uses a catalyst in this way in a secondary reactor. However, when using lime-based minerals, typically carbonates, these are significantly more active if calcined to CaO. However, the combination of CaO with high-chloride fuels such as waste materials, there is an interaction between the lime and halides to form e.g. calcium chloride which has a melting point of 772 °C, that reduces the tar conversion efficiency.

#### **6.2.2.2. Thermal cracking of tars / plasma tar removal**

Thermal treatment to reduce tar, on the other hand, is easier to achieve compared to catalytic tar conversion. There are many examples of thermal post-treatment of the product gas as the main method of addressing tars. Available data from laboratory research for biomass has been compiled by e.g. ECN<sup>197</sup>.

Thermal treatment is the main mechanism for the tar reduction in entrained flow gasifiers that leads to the low content of hydrocarbons in the product gas from this type of gasifier (even if these are rarely used with waste materials). It is also an integrated part of molten bath gasifiers.

---

<sup>195</sup> Advanced biofuel production via gasification – lessons learned from 200 man-years of research activity with Chalmers' research gasifier and the GoBiGas demonstration plant. Henrik Thunman *et al.* Energy Science and Engineering 2018; 6(1): 6–34

<sup>196</sup> Reactive bed materials for improved biomass gasification in a circulating fluidised bed reactor. J. Pecho, T.J. Schildhauer, M. Sturzenegger, S. Biollaz, A. Wokaun. Chem. Eng. Sci., 63 (2008) (2008), pp. 2465–2476.

<sup>197</sup> Tar formation in pyrolysis and gasification. B.J. Vreugdenhil, R.W.R. Zwart. ECN-E--08-087. June 2009. ECN The Netherlands

In the case of fluidized bed reactors, this method is applied in the freeboard zone of the both the Rheinbraun HTW process and the Enerkem processes, see Sections 7.3.2.8 and 7.4.2.2. Since there are solids present in the freeboard, again the temperature used must be moderated to avoid ash issues, as sticky ash may accumulate at the gasifier wall or outlet, or agglomerate and fall into the fluidized bed below causing operational problems.

Plasma gasifiers like AlterNRG and Solena, see Sections 7.3.2.1 and 7.4.2.6, respectively, where plasma is applied mainly to ash melting at the bottom of the moving bed, apply a high operating temperature in the upper part of the gasifier bed. In addition, these gasifiers have a gas cupola, see Figure 64, the equivalent to a freeboard in a bubbling fluidized bed, on top of the moving bed to increase the residence time of the gas at high temperature (+ 1 000 °C), and thereby claim to be able to completely eliminate the tar. To avoid accumulation of sticky ash at the outlet, AlterNRG uses partial quenching at the gas outlet of the cupola. However, plasma gasifiers cannot use solely plasma energy to obtain a high enough operating temperature, since the electric power consumption would be too high. The plasma is therefore typically supplemented by partial oxidation of the fuel or gas using oxygen or air.

Other plasma gasification developers (e.g. CHO, Plasco and APP, see Sections 7.3.2.2, 7.3.2.5 and 7.4.2.1) do not use the plasma torches in the gasifier itself, but these are instead used for high-temperature treatment of the gas in a separate vessel downstream of the gasifier to achieve tar decomposition. Even if the reaction energy is not so high for conversion of only the tars in the gas without any gasification reactions at the same time, oxygen is sometimes also used to limit the electrical consumption.

Studies on thermal methods indicate that relatively high temperatures are required. The data indicate that temperatures well above 1 100-1 300 °C are required for an efficient thermal decomposition of tars with a reasonable residence time<sup>198</sup>. At a residence time of 0.5-1 second magnitude, cracking temperatures of 1200°C or higher are required to thermally crack 95-99.5% of biomass tars<sup>197</sup>. There are also differences between systems where gas is heated from an external source under laboratory conditions (when oxygen is added to generate a partial oxidation reaction to raise the temperature), or if energy is added by means of a plasma. This relates to the formation of radicals that initiate the tar cracking, since the oxidation reactions and the intensity of the plasma give different results and follow different mechanisms. However, since most studies are performed under laboratory conditions using model compounds<sup>197</sup> where the mixing, etc. can be optimized, when scaling up the same performance may not be reached. However, studies<sup>198,199, 200</sup> made in the APP pilot plant indicated that the plasma is effective in reducing the tars without a decrease in the gas heating value which occurs from adding oxygen to reach a similar temperature, due to that oxidation reactions consume some of the combustible gas components. However, the data generally available in literature are not reported in a form where such alternatives can really be compared on a similar basis.

There are also examples of thermal post-treatment for tar reduction using air or oxygen to reach sufficient temperature, e.g. in the Thermostelect process (see section 7.3.2.11), which uses<sup>197</sup> temperatures of 1 200 °C and above, with gas residence times of about 5 s, and also in the technologies used by EUP, Fulcum Bioenergy, Ineos, EUP, Syntech/KEW Technology system<sup>201</sup>, see Sections 7.3.2 and 7.4, in which systems temperatures between 1 050 and 1 200 °C are being used.

<sup>198</sup> Performance analysis of RDF gasification in a two stage fluidized bed-plasma process. M. Materazzi et al. Waste Management 47 (2016) 256-266

<sup>199</sup> Tar evolution in a two stage fluid bed-plasma gasification process for waste valorization. M. Materazzi et al. Fuel Processing Technology. Volume 128, December 2014, P. 146-157

<sup>200</sup> Reforming of tars and organic sulphur compounds in a plasma-assisted process for waste gasification. Massimiliano Materazzi et al. Fuel Processing Technology, Volume 137, September 2015, P. 259-268

<sup>201</sup> Wednesbury Advanced Conversion Plant Permit number EPR/WP3730EP. Environment Agency UK 2014.

The scale-up thermal removal of tar requires a good understanding of the various chemical and mixing phenomena occurring simultaneously in and between different reactor zones to allow changing to the geometry of larger reactors while retaining the same decomposition effect as in pilot or laboratory scale. Here, CFD tools are very valuable in predicting the performance of larger systems.

### 6.2.2.3. Physical tar removal

Another group of methods involves removing tar by condensation and scrubbing, using scrubber types discussed in Section 6.2.1. If there is no high-efficiency particulate removal upstream the quench and scrubbing section, this unit can also be used to remove particulates in parallel to the tars.

Although easier to implement than catalytic or plasma processes, there are several drawbacks associated with scrubbing. The presence of tars reduces the possibilities for heat recovery from the gas. At some temperature below, say, 400 °C tars start to condense and causes fouling of heat exchanger surfaces and in gas cleaning equipment, and if particles are still present, fouling becomes even worse.

To avoid this, quenching by water injection from a fairly high temperature, even directly from the gasifier temperature at over 800 °C, is used. Such quenching reduces the recoverable heat at high temperature. The sensible heat in the gas at the gasifier outlet can amount to 10-20 % of the fuel energy content. By condensation of water, an organic fraction and a contaminated wastewater stream containing particulates also including heavy metals, water-soluble organics such as e.g. phenols and inorganics such as ammonia, hydrogen sulphides, also carrying particulates and a number of inorganic contaminants are produced. The organic tar fraction needs to be recirculated and decomposed in the gasifier or disposed of by other means. However, since tars are essentially very hydrophobic, rapid quenching tend to form aerosols that can be entrained by the gas into downstream units. The quenching and scrubbing are therefore often complemented by a wet electrostatic precipitator to remove solid or liquid aerosols.

A wet electrostatic precipitator (WESP) operates with an inlet gas at water saturation conditions. The discharge electrode charges aerosol and water droplets which travel in the electric field to the collector electrodes, where they coalesce to larger aggregates. The collector electrodes are flushed with water to remove these aggregates and may also be cooled to enhance the collection process by condensing additional water using the aerosols as condensation nuclei. Such devices have been used in similar applications, e.g. for coke oven gas cleaning and for biomass gasifiers.

In addition, even if heavy tars (i.e. naphthalene and  $>C_{10}$  compounds) are mostly removed, the gas still contain benzene, toluene and xylene, as these have neither such a low vapor pressure to allow condensation at ambient temperature in the concentrations present in typical gasification gases, nor sufficient solubility in water to be removed by absorption. If the gas will be combusted in an engine or gas turbine normally this does not require additional measures, but for synthesis gas additional clean-up by e.g. scrubbing or by activated carbon is often necessary. However, there is also an opportunity in recovering BTX as the market value for non-fossil BTX as a chemical is higher than the energy value.

The FICFB<sup>202</sup> gasification system for primarily biomass developed by TU Wien and commercialised by Aerchernig Engineering (*fka* Repotec) uses RME as a scrubbing liquid for tar removal of the product gas, after gas cooling and removal of particulates in a filter. In the scrubber both tars and water are condensed, and the tar fraction is removed by absorption. The RME fraction is separated

---

<sup>202</sup> Six Years Experience with the FICFB-Gasification Process. Hofbauer, Hermann & Rauch, Reinhard & Loeffler, G & Kaiser, Sebastian & Fercher, E & Tremmel, H. 10th Eur. Conf. Technol. Exhib. Wurzburg, Germany, January 2002.

from the water by gravity and a purge stream is sent to the combustion section in the gasifier. The condensed water is used to generate steam for the gasifier and the final amount where organics are concentrated is also injected into the combustor. The experience from GoBiGas is that the energy use in terms of consumption of RME amounts to some 0.5 MW in relation to 30 MW fuel input, i.e. somewhat above 1.5 % of the biomass fuel input energy, and the main separation effect on tars is condensation and the absorption of tars by dissolution in the RME is very limited<sup>195</sup>.

It is also possible to use other washing liquids for scrubbing besides water. The tar removal system of OLGA<sup>194, 203</sup>, developed by ECN (currently ECN part of TNO) in the Netherlands and licensed to Dahlman, see Section 7.4.2.5, is based on a multi-stage scrubber in which gas is cleaned by proprietary scrubbing oil, see Figure 36.

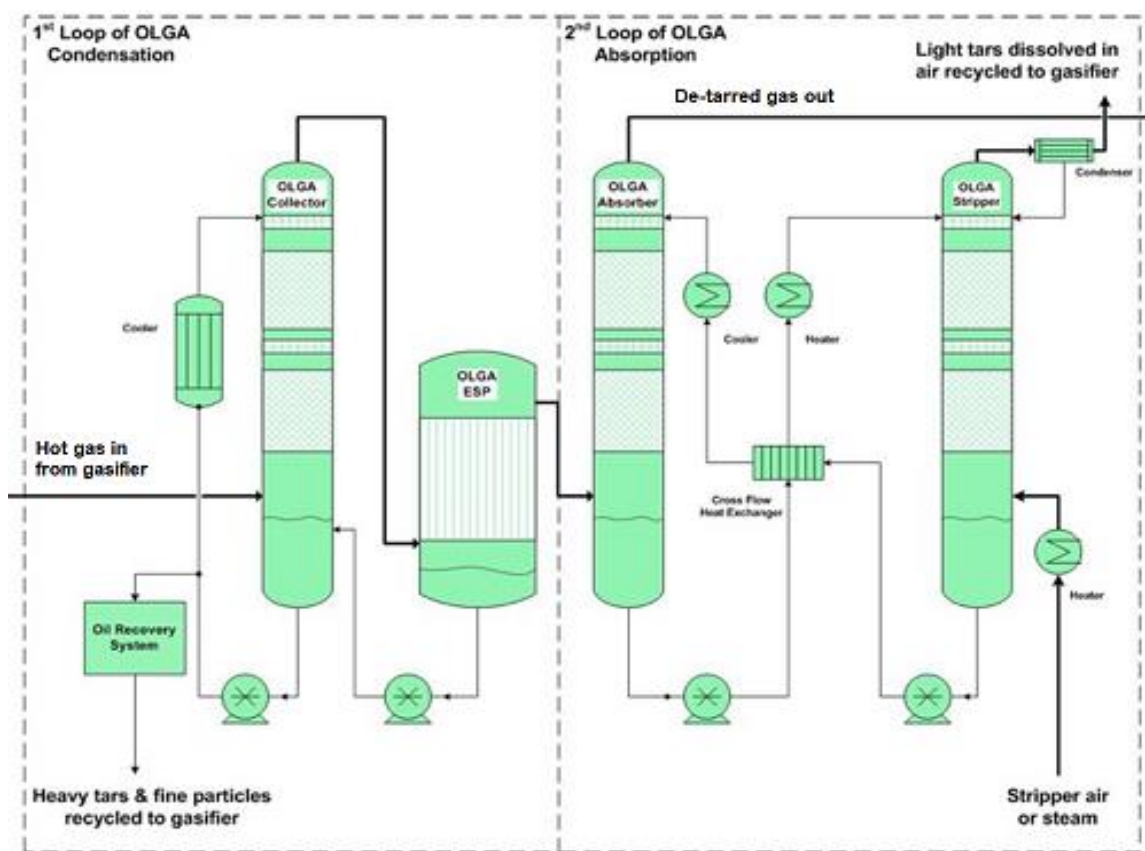

**Figure 36 The OLGA process<sup>203</sup>**

Before entering the OLGA tar removal system, the product gas is cooled to around 400- 500 °C, i.e. above the tar dew point, and the coarse particles are removed by a cyclone. In the first stage scrubbing of OLGA (called collector), the gas is further cooled down to above the water dew point by scrubbing oil. Heavy tars condense and are collected in the oil, from which heavy tar is separated in an oil recovery system and recycled to the gasifier system. To avoid carry-over of tar aerosol and scrubbing oil to the second stage, a WESP is located between the first and the second stage.

In the second stage (absorber column), lighter tars (e.g. phenol, naphthalene, etc.) are absorbed by scrubbing oil above the water dew point (~80°C). The scrubbing oil is thus saturated by these light tars. This saturated oil is then regenerated in a stripper by hot air or steam which is then routed

<sup>203</sup> OLGA Tar Removal. Royal Dahlman B.V. May 2013, <http://www.royaldahlman.com/renewable/home/tar-removal/olga-technology/>



back to the gasification system. For indirect gasifiers, the heavy tar and the stripper gas can be routed to the combustion section, thereby both decomposing the tar components as well as recovering the energy contained in the tar. The main advantage of operating above the water dew point is that tars are removed from the product gas, while water is still present in the gas. This avoids the formation of a troublesome water/tar mixture typical of water scrubbers, which is very challenging to treat in wastewater systems. The OLGA technology has been commercially upscaled and used for mainly biomass gasification plants. The OLGA process was being considered<sup>204</sup> for a planned waste gasification project in the UK and is planned for use in Synova projects in Thailand and the Netherlands, see Section 7.4.2.5. Since tars are removed, the gas can then be subjected to further cooling below the water dew point and additional wet cleaning.

Other washing liquids that have been widely applied is tar liquor, i.e. a pumpable fraction of the condensed tar, or another organic liquid e.g. RME as a solvent for the tar and recirculate a purge stream to the gasifier or dispose of the excess by other means. Using tar liquor is not so costly, whereas the use of RME or other bought-in solvents can easily lead to excessive costs if the tar quantity is high.

#### **6.2.2.4. Temperature control**

Another method to deal with tars consists of maintaining the lines downstream the gasifier at a sufficiently high temperature, e.g. 400 °C to keep the tars remaining in the vapor phase and be consumed when combusting the gas in a combustion chamber or a burner. This measure is applied in many waste gasification plants in Japan and after CFB gasifiers such as in the CEMEX and ESKA plants, respectively, but also at the Metso gasifier at Kymijärvi II, see Section 7.1 and 7.3.2.4, respectively. However, this also means that the gas cleaning for other contaminants becomes limited to, at best, particulates, alkalis and halides, if used at all. Remaining contaminants then have to be eliminated by post-combustion flue gas cleaning.

#### **6.2.3. Halides (chloride, fluoride and bromine)**

The release of halides to the gas phase during gasification is a complex situation, as halides may be retained in the ash and never released, react directly within the fuel to be contained in the ash or released to the gas phase and then react with the ash. At present, there are only formal regulations, e.g. IED, regarding chloride and fluoride, but bromine is increasingly being discussed. Typically, it is the calcium but also the aluminium content of the ash that affects the release of halides, mostly occurring at high temperature, whereas below 700 °C, halides can also be contained as alkali salts. Typically, 50 % or more of the halide content is released to the gas<sup>205,206</sup>.

Main halide components in the gas phase are HCl and (HF and HBr), but halides may also be present as chlorides, mainly NaCl and KCl above the respective melting points of the salts at 801 °C and 770 °C, respectively. There are also some chlorinated hydrocarbons in the tar, depending on the time-temperature history. However, such compounds will decompose to HCl and HF in conjunction with tar decomposition at high temperatures. Bromine can possibly also appear as Br<sub>2</sub>.

The distribution of chloride species in an air-blown waste gasifier is exemplified by Figure 37, resulting from thermodynamic calculations. As indicated in Table 14, the level of removal required for a typical waste can be above 95 % in order to keep below emission limits (in gas combustion applications).

<sup>204</sup> Grimsby Renewable Power. Permit number EPR/DP3132EY. Environment Agency UK 22/12/2014

<sup>205</sup> Release of Chlorine from Biomass at Pyrolysis and Gasification Conditions. E. Björkman, and B. Strömberg. Energy Fuels, 1997, 11 (5), pp 1026–1032.

<sup>206</sup> Experimental Investigation of the Transformation and Release to Gas Phase of Potassium and Chlorine during Straw Pyrolysis. A. Jensen, F. J. Frandsen, K. Dam-Johansen and B. Sander. Energy Fuels, 2000, 14 (6), pp 1280–1285

For the gas application for chemical synthesis, the cleaning requirements are even more stringent than for use as a fuel gas in e.g. boilers/gas engines, as halides are well-known catalyst inhibitors and can also form volatile species with some metal compounds used in catalysts at higher temperature.

If alkalis are present in excess relative to the halides, cooling the gas to below 300-400 °C causes condensation as alkali halide salts, the condensation being initiated below 700 °C, cf. Figure 37. Such solids can then be removed by an efficient dry particulate removal system. The affinity for alkali increases in the order of: F < Cl < Br.

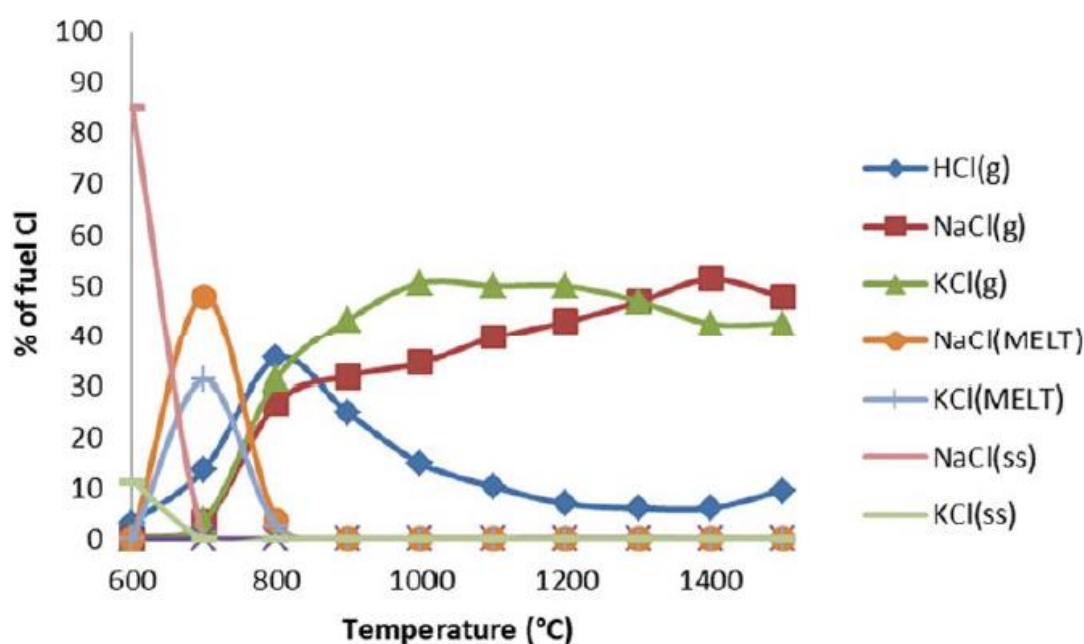

**Figure 37 Theoretical distribution of chlorine species in RDF gasification<sup>207</sup>**

As in the case of tar removal, for removal of halides from product gas there are dry methods and wet cleaning methods. HCl and HF can react with calcium in the fuel ash or injected as a sorbent into the gas as oxide, hydroxide and carbonate at intermediate temperatures to remove the majority of the chlorides and fluorides, but it is less active for bromine (if available in sufficient quantity, as the cation affinity for calcium increases in the order of Br, Cl, F due to the decreasing ionic radius). Going further than what can be achieved by lime injection, where the relatively high stability of CaCO<sub>3</sub> is a limiting factor, sodium bicarbonate or other sodium carbonate salts can also be used to achieve a very high pick-up, sufficient to meet emission requirements<sup>208</sup>. This reactant and the associated cleaning process also appear in the descriptions of the APP process, see Section 7.4.2.1.

When sorbents are used, this is combined with high-temperature filtration in ceramic filters to separate ash particulates and the loaded sorbents at above 350 °C. The reason for this temperature is in most cases to avoid tar condensation in the filter, but when both HCl and ammonia are present below 300 °C, ammonium chloride (salmiak) is formed as an aerosol. This material tends to accumulate at colder points in the system, and it can also cause pressure drop increase in fixed beds. Since ammonium chloride is very hygroscopic, such accumulations can absorb water and be

<sup>207</sup> S-Cl-Na-K Chemistry During MSW Gasification: a Thermodynamic Study. Michael Becidan. CHEMICAL ENGINEERING TRANSACTIONS, VOL. 43, 2015

<sup>208</sup> This process, sometimes called the Solvay or Trona process is used in waste incinerators e.g. in Japan but also e.g. in the Kymijärvi II plant

dissolved when the plant is off-line, and the gas system is colder than normal. Such accumulations are one factor that causes standstill corrosion in incinerators using SCR and SNCR. The largest, but also this far the only, gasifier installation using such filters is the Kymijärvi II plant. However also other plants are using or planning this type of halide removal.

Both HF and HCl are strong acids that are easily dissolved in water, and even more easily dissolved if the water is made alkaline. However, the presence of CO<sub>2</sub> in the gas that also forms an acid, can cause an increased consumption of chemicals to maintain the pH on the basic side. An intense scrubbing process followed by separation of droplets e.g. in an electrostatic precipitator (WESP) is another feasible mean to achieve the very high cleaning requirement defined for waste incinerators.

For cleaning to very pure gas, e.g. for use as synthesis gas, scrubbing may not be sufficient and would require additional cleaning by sorbents in fixed beds, bi-metallic oxide sorbents, alkali bicarbonate pellets, activated carbon, activated alumina, etc., where experience exists from refineries and chemical plants. Since synthesis gas applications are mostly utilizing pressurized gas, a reasonable space velocity can be applied in the contact with catalysts and sorbents, but in the case of a gas close to atmospheric pressure, due to pressure drop restriction, large volumes of sorbents in multiple vessels may be required.

#### **6.2.4. NO<sub>x</sub> precursors**

There are several sources of formation of NO<sub>x</sub> in combustion applications, some of which are related to thermal formation of NO from the reaction of the main constituents of air or the prompt formation from hydrocarbon radicals in the flame reacting with nitrogen in the air, but also from oxidation of nitrogen compounds in the fuel itself. For the latter reaction, the conversion to NO is very high. Depending on gas composition and operating conditions, typically 50-90 % of the gaseous nitrogen-containing precursors (NH<sub>3</sub>, HCN and nitrogen containing organics originating from the fuel-bound nitrogen) are converted to NO<sub>x</sub> (the lower the content of the precursors, the higher the conversion by oxidation), and this source of NO<sub>x</sub> is the only one that can be effectively addressed by gas cleaning before the combustion of the gas.

Waste fuels typically have a relatively high nitrogen content, see Table 1 and Table 2 while, depending on the gasifier technology, 25-95 % of fuel-bound nitrogen is converted to emission precursors during gasification that can subsequently be oxidized when the gas is combusted, as described above. This means that typically 20-50 % of the fuel nitrogen can end up as NO<sub>x</sub>, so there is a need for far-reaching gas cleaning to meet limiting emission levels. From Table 14 it can be concluded that a magnitude of less than 10 % of the fuel nitrogen is acceptable in the final fuel gas product from emissions standards, if post-combustion clean-up should be avoided or limited.

Most of the fuel-bound nitrogen ends up as ammonia during the gasification process. The HCN content is typically a few percent of the fuel-bound nitrogen, but under certain conditions, mainly relating to very high temperature operation or when polymers containing cyano-groups (e.g. polyurethanes, nitrile rubbers) constitute an unusually high fraction of the feedstock, HCN can be at a higher share of the fixed nitrogen components, 10 % or more. It can then be present to an extent that it is not sufficient to only decompose tar and remove ammonia, also HCN needs to be removed to meet emission requirements. In addition, the presence of HCN in wastewater would also be a concern.

In the case of ammonia, there are no dry processes in use under the conditions prevailing in a gasifier and in the gas cooling/cleaning section down to the steam dew point. Catalytic methane and tar steam reforming by nickel catalysts would also decompose ammonia, but as noted in Section

6.2.2.1, for waste gasification catalyst are not in use. However, there have been efforts to develop catalytic systems for the decomposition of ammonia<sup>209</sup> and there are developments to achieve dry removal of ammonia using e.g. regenerable acidic zeolites<sup>210</sup>. The most common approach for ammonia removal, however, is to use wet scrubbing. Ammonia, being a strong base, can typically be removed in water, in particular if strong acids are present in the gas, such that there is a synergy between ammonia removal and HCl removal, but where one or the other of these components are then limiting the balance. Therefore, a water scrubbing section can be designed to remove most of the ammonia, but this requires that a relatively low pH is used, contrary to the optimum requirements for removal of acids. Using only neutral water would result in a very dilute solution. Since a wastewater system would in many cases also be required to treat ammonia prior to discharge to a recipient, the gas cleaning and water cleaning are in practice closely connected.

HCN, on the other hand, in spite of being an acid, is more difficult to dissolve in water than strong acids. Here, and as a part of the final gas purification, a catalytic hydrolysis reactor at 150 to 200 °C can be used to hydrogenate HCN to ammonia in parallel to the conversion of COS to H<sub>2</sub>S, to be removed by water upstream of the sulphur removal. Again, for a pressurized gas this can be done more easily, whereas pressure drop restriction can raise the volume of catalyst required, and hence the cost.

### 6.2.5. Sulphur species

The main sulphur-containing species in the gasification gas are H<sub>2</sub>S and COS, typically representing more than 90% of the sulphur in the fuel. Overall COS may be 3-10 % of the total sulphur. If these components are present in the gas during combustion, they oxidize to SO<sub>2</sub> (and to some extent to SO<sub>3</sub>). Other sulphur components are organic species such as mercaptans/thiols (R-SH) and hetero-rings like thiophene that can be present in the ppm range, and therefore of importance to synthesis gas systems. There are a number of publications summarizing various aspects of sulphur removal from various gases<sup>211, 212, 213</sup>.

#### Dry high temperature processes

Since the introduction of coal-based town gas in the late 19<sup>th</sup> century, there has been a continuous search for materials for the economic dry removal of sulphur from gases, further triggered in the 1980's and 1990's due to the interest in coal- and biomass-based IGCC power plants.

There are no established dry processes to remove sulphur economically from a gasification product gas. Without an upstream tar removal, the presence of tars in a dry process sets a minimum operating temperature to avoid their condensation, and tars can also interact with high surface sorbents in an undesirable way. In addition, also the chemical kinetics of the generic reaction shown in the forward direction in the first formula below can be a limitation at lower temperatures, even if from thermodynamics, the residual H<sub>2</sub>S contents (sulphur slip) decreases with a decreasing temperature.

An exception to this is lime, which can be used to form calcium sulphide, but this reaction can only be efficiently performed at high temperature, 900°C, due to competition with CO<sub>2</sub> being present at higher concentrations and that readily forms calcite (CaCO<sub>3</sub>). However, even under optimum

<sup>209</sup> Catalytic conversion of nitrogen compounds in gasification gas. Fuel Processing Technology. Jukka Leppälähti, Pekka Simell, Esa Kurkela. Fuel Processing Technology. Volume 29, Issues 1–2, November 1991, Pages 43-56.

<sup>210</sup> RTI Warm Syngas Cleanup Technology Demonstration. Raghbir Gupta. Gasification India 2016. New Delhi, India, 11-12 February 2016

<sup>211</sup> Synthesis Gas Purification. D. Chiche, C. Diverchy, A.-C. Lucquin, F. Porcheron and F. Defoort. Oil & Gas Science and Technology – Rev. IFP Energies nouvelles, Vol. 68 (2013), No. 4, pp. 707-724

<sup>212</sup> Biogas upgrading technologies –developments and innovations. A. Petersson, A. Wellinger. IEA Bioenergy, Task 37 - Energy from biogas and landfill gas, 2009

<sup>213</sup> Tail gas treatment of sour-SEWGS CO<sub>2</sub> product. H.A.J. van Dijk. Juni 2012. ECN-E--12-025, ECN, the Netherlands

conditions the cleaning effect is limited thermodynamically to residual H<sub>2</sub>S contents (sulphur slip) that are higher than allowed for emission control<sup>214</sup>. Also, the presence of CaS in ash streams causes some issues, as the H<sub>2</sub>S can be released again in contact with water, and the sulphide can also be oxidized to sulphate in contact with oxygen, a reaction which is exothermic.

There are also non-regenerable solid sorbents such as molecular sieves or zinc oxide that are used for natural gas treatment and in the chemical industry for removing smaller quantities of sulphur from a gas, typically at ppm levels and often preceded by other bulk sulphur removal processes such as wet scrubbing absorption processes, see below. However, these throw-away materials are far too costly for bulk removal of sulphur above, say, 10 ppm.

One aspect of fulfilling the economic criteria is that the sorbent consumption is reasonable from a cost perspective. For once-through systems, this criterion can be met by calcium minerals such as lime and dolomite, but, as noted above, even if the removal efficiency (i.e. sulphur removed/sulphur at inlet) can be high in the case of high sulphur coal, the residual sulphur content in the gas is still too high to meet environmental requirements or, alternatively, the approximate 10 ppm level, where the commercially available sorbents like zinc oxide could be considered as cost effective for polishing.

Therefore, there has also been a development of regenerative systems based on metal oxides corresponding to the reactions exemplified below:

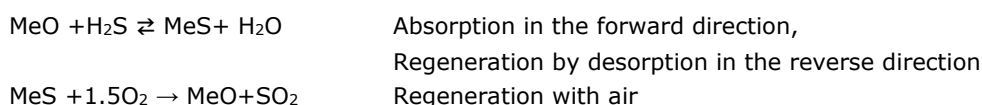

Some of the candidate materials as regenerative metal-based sorbents are shown in Table 18.

**Table 18** Examples of regenerative sorbents tested for dry sulphur removal<sup>215</sup>.

Sorbent material	Sulfidation temperature, °C	Regeneration temperature, °C	Sorbent utilisation, % of theoretical	H <sub>2</sub> S slip, ppmv
Tin oxide	350-500	400-500	85	< 100
Copper oxide	350-550	650	70	< 20
Manganese oxide	350-870	900	50	< 10
Iron oxide	360-500	500-650	25-45	< 100
Zinc oxide	480-540	500-700	50-70	< 1
Zinc ferrite	450-600	600	20-80	< 20
Zinc titanate	450-750	600-750	40-60	< 10
Copper chromite	650-850	750	40-80	< 10
Cerium oxide	750-1000	6000	90	< 100

The table indicates operating temperature, regeneration temperature, typical sorbent utilization as percent of the theoretical sulphur uptake (for most oxides, typically the theoretical uptake of sulphur is 15-25 % by weight) and the residual H<sub>2</sub>S in the gas. For the first reaction, a gas with high

<sup>214</sup> A thermodynamic study of dolomite as a hydrogen sulfide adsorbent when pyrolyzing of partially gasifying coal. K. Sjöström, T. Liljedal. Fuel, 71 (1992), p. 797

<sup>215</sup> Optimisation of Experimental Conditions for Ex-Bed Desulfurization. J. M. Sánchez et al. 2010. FLEXGAS Project, D6.3 Informes Técnicos Ciemat 1216, Octubre, 2010, CIEMAT, Spain.

steam content results in an increased sulphur slip from equilibrium effects. On the other hand, and unfortunately, a high sorbent affinity for sulphur, such as is the case for ZnO, is in practice off-set by difficulties in reversing the reaction, requiring higher temperatures and/or large quantities of steam. Achieving high regeneration temperatures costs energy and has chemical impacts on the sorbent and practical operational limitations. In addition, since the typical concentration for H<sub>2</sub>S in the regeneration stream in practice is of the order of one to three magnitudes higher than the residual H<sub>2</sub>S content in the gas, say 1-10 ppm, arriving at a sufficiently enriched regeneration stream for further treatment of the H<sub>2</sub>S can also be a limitation.

The H<sub>2</sub>S gas released can be sent to a boiler equipped with flue gas desulfurization processes and burned, oxidized with air or hydrogen peroxide to produce sulfuric acid processes suitable for smaller gas flows and sulphur quantities, or fixed by liquid oxidation processes, see below. The common Claus process (oxidation of 1/3 of the H<sub>2</sub>S to SO<sub>2</sub>,  $\text{H}_2\text{S} + 1.5 \text{O}_2 \rightleftharpoons \text{SO}_2 + \text{H}_2\text{O}$ , followed by a catalytic multi-stage reaction between this SO<sub>2</sub> and the remaining H<sub>2</sub>S to elemental sulphur,  $\text{SO}_2 + 2\text{H}_2\text{S} \rightleftharpoons \text{S}_2 + 2\text{H}_2\text{O}$ , net reaction  $\text{H}_2\text{S} + 0.5\text{O}_2 \rightleftharpoons 0.5\text{S}_2 + \text{H}_2\text{O}$ ) is typically not used for biomass and waste gasification systems, although it is used for coal and oil gasification, since the quantity of sulphur to recover is too low to make the process feasible and/or the H<sub>2</sub>S stream is too dilute to allow the efficient use of this process.

By using mixed oxides containing zinc and another more regenerable oxide, the latter can remove the bulk of the sulphur, whereas the zinc achieves the polishing<sup>216</sup>. However, the activity of the zinc is reduced by dilution, such that the sulphur slip is higher than for pure materials. To facilitate the regeneration, the second, oxidation reaction above is being developed. The oxidation is exothermic, such that the oxygen content of the regeneration gas needs to be controlled to low concentrations to avoid too high temperatures that could cause sintering or other deterioration of the sorbent. For many of the sorbent candidates, there is also a side-reaction of forming a small fraction of metal sulphate. Therefore, after an accomplished oxidative regeneration, to complete the full cycle, any metal sulphates need to be reduced to H<sub>2</sub>S to avoid slip of H<sub>2</sub>S in the next absorption next cycle. This is done in a second regeneration step where a reducing process gas is used to fully restore the sorbent before it can be returned to service. This reduction gas is then recycled to the desulfurization feed gas. Also, the SO<sub>2</sub> gas formed during the combustion of the product gas needs to be treated prior to release. It can be fed to some auxiliary boiler on site equipped with a flue gas sulphur removal system. Another method is to oxidize the SO<sub>2</sub> to SO<sub>3</sub> which can be absorbed in water to form a sulfuric acid by-product. A third method is to reduce SO<sub>2</sub> to elemental sulphur by consuming some of the upgraded product gas and recycle the tail gas containing also some H<sub>2</sub>S formed during the reduction, or by using wet oxidation methods, see below.

However, apart from the ZnO throw-away system used between 250 and 400 °C, only one of these sorbents<sup>210, 216, 217</sup> based on ZnO supported on zinc aluminate has reached a state where it has been tested extensively in coal gasification gas and commercial opportunities are now sought. The applicability to the somewhat more complex waste gasification gas and the feasibility of its application in smaller gas streams than present in coal gasification remains to be demonstrated.

### **Wet processes**

In the absence of established hot gas, dry, cleaning methods for gasification gases in general and the added complexity if tars are present, the processes for sulphur removal are typically carried out after removal of tar and after water scrubbing. Processes used are mainly by scrubbing in an

---

<sup>216</sup> Status of RTI/Eastman Warm Gas Clean-up Technology and Commercialization Plans. Raghubir Gupta *et al.* Gasification Technologies Conference. October 8, 2008

<sup>217</sup> High-Temperature Sulfur Removal in Gasification Applications. Raghubir Gupta. <http://www.topsoe.com/file/high-temperature-sulfur-removal-gasification-applications>

absorption system or by regenerable sorbents at ambient temperatures.

Unlike SO<sub>2</sub>, which is a reasonably strong acid (pKa= 1.81), H<sub>2</sub>S is a weak acid (pKa= 6.9) like CO<sub>2</sub> (pKa= 6.3) that requires high alkalinity to be dissolved in water, whereas COS is not readily dissolved in water solution at any pH.

To ensure that sufficient sulphur is removed to meet end-use requirements (for example, if the gas is applied for synthesis applications), the treatment first catalytically hydrolyse COS to H<sub>2</sub>S, as discussed in relation to HCN in Section 6.2.4, and then remove the bulk H<sub>2</sub>S by a scrubbing process, followed a non-regenerable guard bed polishing.

In many applications involving chemical synthesis, it is required or desirable to also remove the other weak acid present, CO<sub>2</sub>, simultaneously with the H<sub>2</sub>S. There are many processes available for this purpose at large scale applied in chemical industry and refining, separated into chemical washes using bases such as amine alcohols (MEA, DEA, MDEA) or basic chemicals like potassium carbonate (Benfield), and physical washes using water, methanol (Rectisol<sup>®</sup>), or more complex organic compounds (Sepasolv<sup>®</sup>, Molysorb<sup>®</sup> etc.), alone or as water solutions. There are also processes that apply both principles in parallel. These processes are based on an absorption-desorption cycle. These processes are with some variation not so specific for the removal of sulphur, depending on the reactant or solvent used. However, as CO<sub>2</sub> is typically present in the gas at least one or two magnitudes higher concentration than sulphur species, there is in most cases a very significant co-absorption of CO<sub>2</sub>. Despite this, some of these processes can be arranged by staging and split regeneration to have a quite concentrated H<sub>2</sub>S stream for further treatment.

The chemical wash systems are based on the absorption and hydrolysis of the acid gas component to react with the base component, i.e. the solvent capacity is related to the concentration of the active base component. The chemical reaction enhances the absorption and can therefore be applied also at atmospheric pressure but requires a high amount of energy for the regeneration as the chemical reactions are associated with reaction heat (typical values are 1-2.5 MJ/kg acid gas removed). The simplest form of chemical wash is to use alkaline scrubbing using caustic (NaOH). In this case, regeneration is not applied; instead, the sulphide captured is oxidized to sulphate and rejected to the sewage system. The cost of sodium hydroxide is below 1€/kg and for sodium hypochlorite of the order of 2-3 €/kg, but the latter is used on a molar ratio of 4, such that the cost amounts to 20-30€/kg S, which may still be acceptable for small plants. This is difficult to compare with other methods for removing sulphur, as these involves both significant capital and operating costs that are dependent on the process used, the scale and other conditions.

Physical wash systems use the solubility in the absorption medium without chemical reactions, i.e. the energy requirements are lower than chemical wash systems, since generally, absorption heats are lower than reaction heat (typically < 0.5 MJ/kg acid gas removed). However, since the absorption capacity is related to the partial pressure of the solute, pressurized operation at typically 2.5 MPa or more is required, and also since a partial desorption is accomplished by pressure let-down as a first regeneration step to save energy, followed by a thermal regeneration. Since solubility typically increases with decreasing temperature, some processes also use sub-ambient temperatures, e.g. Rectisol. There are many descriptions of such processes<sup>218</sup>, a good discussion can be found in e.g. a report from NREL<sup>219</sup>. However, for reasons of economy of scale, waste

---

<sup>218</sup> For example; Gas Purification (Fifth Edition), Arthur Kohl, Richard Nielsen. Gulf Publishing Company, Houston, Texas, USA, 1997.

<sup>219</sup> Survey and Down-Selection of Acid Gas Removal Systems for the Thermochemical Conversion of Biomass to Ethanol with a Detailed Analysis of an MDEA System

Task 1: Acid Gas Removal Technology Survey and Screening for Thermochemical Ethanol Synthesis March 2009

Task 2: Detailed MDEA Process Analysis September 2009.

Nexant Inc. San Francisco, California. Subcontract Report NREL/SR-5100-50482, NREL, USA, May 2011

gasification plants are mostly small and the use of such established processes very costly.

For fuel gas application, although the removal of CO<sub>2</sub> improves the heating value of the gas, which may be important for some critical applications, the practice is to not actively remove CO<sub>2</sub> in addition to the quantity co-absorbed when removing sulphur species. The removal of CO<sub>2</sub> is costly both in investment and operating costs (energy), in particular at atmospheric pressure, while the increased heating value could lead to thermal NO<sub>x</sub> formation when burning the fuel gas.

To have an even higher selectivity to remove H<sub>2</sub>S down to levels below 10 ppm, there are a number of so-called liquid oxidation processes (LOX) (e.g. Lo-Cat<sup>®220</sup>, Sulferox<sup>®221</sup>, Thiopaq<sup>®222</sup>, and Crystasulf<sup>®223</sup>) available that can operate both at atmospheric and elevated pressure using chemicals or even microorganisms to oxidize the hydrogen sulphide to elemental sulphur, which is recovered as solids or sludge. Typically, without posttreatment, the sulphur sludge can be disposed of by landfilling, but if re-melting is used, a sellable sulphur product can be obtained.

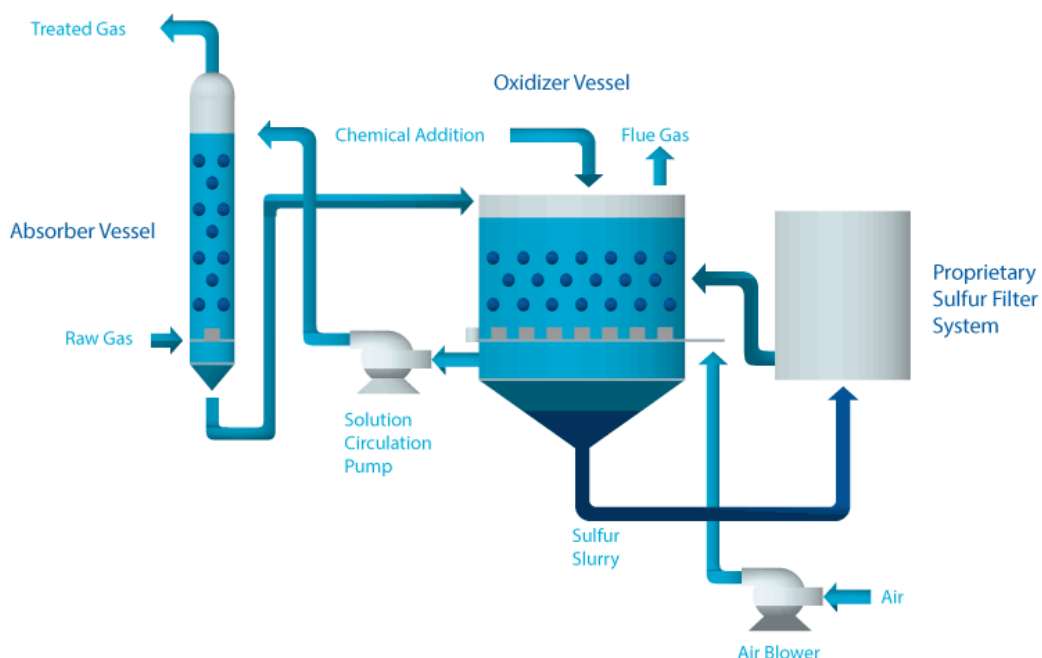

**Figure 38 The Lo-Cat process<sup>220</sup>**

One type of process typically uses a short-time contact scrubber, see Figure 38, where an alkaline water solution absorbs the hydrogen sulphide as its ion form (H<sub>2</sub>S can dissolve and hydrolyse to HS<sup>-</sup> whereas CO<sub>2</sub> first has to react with water to H<sub>2</sub>CO<sub>3</sub> to only thereafter hydrolyse to HCO<sub>3</sub><sup>-</sup>, which kinetically favours sulphur absorption). In the LO-Cat and Sulferox processes, the liquid also contains a chelated<sup>224</sup> iron as Fe(III) that rapidly oxidizes the hydrogen sulphide ions to elemental sulphur, which further enhances the absorption of H<sub>2</sub>S over CO<sub>2</sub>, while returning the iron to Fe(II). The solution is then brought to a sparger vessel where air bubbling is used to re-oxidize the iron to the trivalent state, but also to separate the sulphur formed by flotation as sulphur froth on the surface of the liquid. The sulphur froth can then be skimmed off for further enrichment, and possibly purification by melting and re-crystallization. In the Thiopaq process, the loaded solution contains

<sup>220</sup> <http://www.merichem.com/LO-CAT-Flexible-H2S-Removal-Process>

<sup>221</sup> SULFEROX<sup>®</sup> Converting hydrogen sulphide to elemental sulphur. Shell Global Solutions B.V. 2011

<sup>222</sup> <http://en.paques.nl/products/featured/thiopaq>

<sup>223</sup> [http://www.gastechnology.org/market\\_results/Pages/EnergyConversionCommercializedProducts.aspx](http://www.gastechnology.org/market_results/Pages/EnergyConversionCommercializedProducts.aspx)

<sup>224</sup> EDTA, HEDTA, NTA, DTPA etc.



specialized and harmless bacteria instead of iron oxide that under the influence of air in a sparger tank oxidizes the sulphide to sulphur.

Despite the staging and use of intermediates such as chelated iron ions, the overall reaction formula is the same as the overall formula for the well-known Claus process even if this process proceeds in several stages:

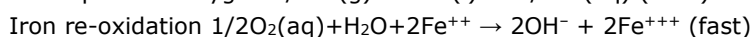
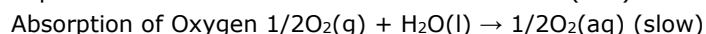
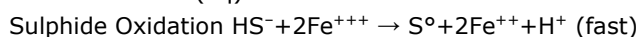
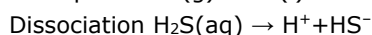
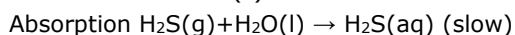
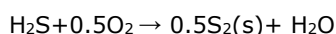

The drawbacks of these processes are that they are known to have a certain chemical consumption, they are maintenance-intensive and that some by-products (sulphates, thiosulphates) are produced that require purging. Using such methods implies some limitations on the feed gas. Hydrocarbons present in the product gas may cause foaming and other disturbances. During aeration, volatile hydrocarbons, if still present in the gas after cleaning, like benzene or naphthalene, are released to the air, such that untreated venting may not be allowed. Also, the pH in such systems must be kept under control by buffering such that any addition of HCl or ammonia that drives pH causes can increase in chemical consumption and from purging to maintain avoid accumulation of undesirable ions. However, in spite of this they are in frequent use in various industries such as natural gas upgrading, refining, biogas production, chemical industries, rayon manufacture.

The Crystasulf® process uses a high-boiling organic liquid in which both H<sub>2</sub>S and elemental sulphur is soluble into which gaseous or liquid SO<sub>2</sub> is dosed and is contacted with the gas. The H<sub>2</sub>S is absorbed in the hydrocarbon liquid, which has no affinity for CO<sub>2</sub>, and proceeds via the second sub-reaction of the Claus process:

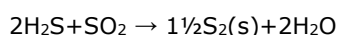

The solid product containing dissolved elemental sulphur is cooled down and the sulphur is crystallized and separated from the solution by a filter. This process is rather novel and operating experiences are more limited although it is claimed that it is in use for waste gasification systems<sup>225</sup>.

#### **Low temperature adsorbents**<sup>211, 213, 218, 226, 227</sup>

Hydrogen sulphide and other sulphur species can be captured by adsorbents such as zeolites and activated carbons or by reactions with iron oxide at low temperatures, both for removal service and as guard beds. This requires other forms of upstream cleaning to remove tars, particulates, acids, etc., that would otherwise co-absorb or block adsorption beds. Since gasification gas typically contains water vapor, co-absorption of water is limiting the use of zeolites in addition to cost. Adsorbents are typically applied in fixed bed arrangements, where two or more vessels are used to ensure continuous desulfurization.

For activated carbon, instead the gas needs to have a certain level of humidity, 30-90 %. The relative humidity causes a liquid phase to form in the pores where H<sub>2</sub>S can dissolve and dissociate prior to be adsorbed on the carbon. Activated carbons in themselves do not have a very high

<sup>225</sup> Using SEWGS and CrystaSulf® to manage CO<sub>2</sub> and H<sub>2</sub>S from coal gasification at high-pressure. Bryan Petrinec, Bill Steen, Carl Richardson. URS Corporation

<sup>226</sup> Biogas desulfurization with doped activated carbon. S. Rossow et al. Landtechnik 64 (2009), no. 3, pp. 202 - 205

<sup>227</sup> Trade literature from e.g. Norit, Cabbot, Donau Carbon, General Carbon, Desotec and others.

sulphur capacity. To enhance the adsorption, impregnation with alkaline salts (NaOH, NaHCO<sub>3</sub>, etc.) is also used, whereby the adsorption capacity is more or less related to amount of impregnation by the stoichiometry. Activated carbon can also be used to catalytically oxidize hydrogen sulphide to elementary sulphur and water at ambient temperatures and sulfuric acid at higher temperatures. To some extent, oxygen in the activated carbon matrix remaining from its activation process can do this to a limited extent but for a higher conversion oxygen needs to be added to the process, typically 2-4 times the H<sub>2</sub>S content. To enhance this reaction, impregnation by e.g. KI is used.

The sulphur-containing activated carbon can either be regenerated or replaced with fresh carbon when it is saturated. Regeneration can be accomplished by steaming to release H<sub>2</sub>S on non-impregnated carbons, by washing and reimpregnation for alkaline-impregnated carbons or by evaporation, dissolution or melting in the case of a sulphur product. However, regeneration is not complete, therefore after a number of cycles, the carbon loses its adsorption capacity and needs to be replaced.

Actual data for the use of activated carbon for sulphur removal at industrial conditions are difficult to find in the literature. However, based on some of the literature, the performance can be summarized as below. Activated carbon can be used to achieve a hydrogen sulphide slip of 1 ppm. The various types of carbons used, differences in the process conditions such as inlet H<sub>2</sub>S concentration, outlet H<sub>2</sub>S concentration, relative humidity, etc. also means that the resulting sulphur loading can vary over a large range from a few % to tens of % by weight. Data on effective consumption is difficult to find.

When used as a guard bed, i.e. to remove sulphur from an inlet of a magnitude 1 ppm and/or to act as a redundancy device for upsets in any upstream sulphur removal system, activated carbon impregnated with metal oxides with high affinity for sulphur, e.g. CuO is used.

Although there are very apparent advantages for hot gas sulphur removal, it has not been part of the conceptual design of gas cleaning installations for waste gasifiers. In Table 19, the actual sulphur removal methods used or planned for use in different waste gasification installations, as far as it is possible to identify this from public documents, are listed.

#### **6.2.6. Heavy metals, mercury**

In the chemical environment and temperature of the gasifier, several species can vaporize as metals (Zn, Hg), or as chlorides or sulphides (Cd, Zn, Hg) and leave the gasifier in the gas phase, in addition to alkalis already discussed. In Table 20 the predominant form of some of the metals of concern at different temperatures is shown. However, and as can be seen in Table 20, as the gas temperature is progressively decreased in the gas cleaning system, these vapours condense either on the surface of other particles present or as very small particles formed on condensation nuclei. Therefore, the particulate cleaning methods described in Section 6.2.1 are effective for the removal of such metals.

The main exception to this is mercury, where the metal and also some other species, notably the mercury chloride, have a high enough vapor pressure to be retained in the gas in significant concentrations after cooling and dust removal. To limit the emission of mercury, adsorption on special impregnated activated carbons is used where mercury is bound as sulphides, thereby depressing the vapor pressure of mercury metal in the gas. This method is also used on flue gases in incinerators and also elsewhere where mercury can occur.

#### **6.2.7. TOC, dioxins and furans, CO**

Although in form of hydrocarbons in the gas in the gasifier, also including traces of chlorinated compounds emanating from e.g. plastics, the reducing conditions at high temperature makes

oxygenated compounds such as furans and dioxins less likely to be formed or survive at gasifier conditions while the absence of oxygen prevents *de novo* formation<sup>228</sup>. Still, at gasifier conditions, in particular for high-ash, high-chlorine fuels and at low temperature gasification, some limited amounts of dioxins can be formed<sup>229</sup>. The fate of these dioxins will depend on the gas cleaning, e.g. thermal treatment for tar removal, scrubbing processes for tar and particulates, use of activated carbons, etc.

However, since the most common use of the gas is combustion at high temperatures, dioxins and other combustible gas components present in the fuel gas are likely to decompose, while dioxins observed in the flue gas after combustion may be formed during the combustion step.

In addition, the effective removal of chloride in the gas cleaning prior to the combustion, if used as is the case in the Kymijärvi II plant, 7.3.2.4, is a factor that prevents the occurrence of conditions of so-called *de novo* formation of dioxins in the gas furnace and furnace exhaust.

Even if the CO content in the product gas is high, tens of vol.%, any remaining CO in the flue gas is more related to the combustion efficiency and control than the presence in the fuel gas.

**Table 19 Applied sulphur cleaning technologies in waste gasification projects (For further details see Sections 7.3.2 and 7.4)**

Project, technology	Gas use	Upstream S processing	Sulphur removal
Air Products, Teesside, UK	GT-CC	COS hydrolysis	Liquid oxidation (LO-Cat)
APP, Tyseley, UK	Synthesis	NaHCO <sub>3</sub>	Alkaline scrubbing* + guard bed
CHO Power, Morcenx, FR	ICE		PAC
Dahlman, Grimsby, UK	GT-CC		Post-combustion
Energem, Alberta Biofuels, CA	Synthesis		(n.a. proprietary)
INEOS, Vero Beach, FL, USA	Synthesis		Post-combustion (Liquid ox. planned)
Fulcrum, ND, USA	Synthesis	COS hydrolysis	Amine wash + liquid oxidation
JFE Thermoselect Chiba, Izumi, Nagasaki, Fukuyama, Osaka. Kurashiki, Isahaya, Tokushima, Yorii, JP	ICE		Liquid oxidation (LO-Cat)
MHI (Thermoselect). Mutsu JP	?		Liquid oxidation (Takahax)
Plasco, Trails Road, Ottawa, CA	ICE		Thiopaq, changed to MACT liquid oxidation
SynTech Bioenergy, Wednesbury,	ICE	NaHCO <sub>3</sub>	Alkaline scrubbing, PAC
Thermoselect, Fondotoce IT	ICE		Lo-Cat
Thermoselect, Karlsruhe, DE	ICE		Sulferox
Thermoselect, Malagrotta, IT	ICE		LO-Cat?
UBE, JP	Synthesis		LO-Cat+ guard

<sup>228</sup>Formation of dioxins and furans during municipal solid waste gasification. E. J. Lopes *et al.* Braz. J. Chem. Eng. vol.32 no.1 São Paulo Jan./Mar. 2015.

<sup>229</sup>Dioxins in gasification The Northwest Florida Renewable Energy Center plant evaluation. Mariusz Cieplik *et al.* ECN-L--09-126, ECN, the Netherlands, October 2009

\*hypochlorite oxidation in process water  
 Gt-CC: gas turbine combined cycle ICE: internal combustion engine.

**Table 20 Gaseous trace element species in gasification gas<sup>217</sup>**

Element	>1000°C	400° to 800°C	100° to 400°C	<100°C
As	AsO, AsS, As Condensed	AsO, As, As <sub>2</sub> S <sub>3</sub>	Condensed Species	Condensed Species
Be	Be(OH) <sub>2</sub>	Cond. species	Cond. species	Cond. species
Hg	Hg HgS, HgO,	Hg	Hg, HgCl <sub>2</sub>	Hg, HgCl <sub>2</sub>
B	HBO	HBO	HBO	
V	VO <sub>2</sub>	Cond. species	Cond. species	Cond. species
Se	H <sub>2</sub> Se, Se, SeO	H <sub>2</sub> Se	H <sub>2</sub> Se	H <sub>2</sub> Se
Ni	NiCl	Condensed species	Ni(CO) <sub>4</sub> (high p <sub>CO</sub> )	Ni(CO) <sub>4</sub> (high p <sub>CO</sub> )
Co	CoCl <sub>2</sub> , CoCl	Cond. species	Cond. species	Cond. species
Sb	SbO	SbO	Sb <sub>2</sub> S <sub>3</sub>	Sb <sub>4</sub> S <sub>3</sub>
Cd	Cd	Cd	CdCl <sub>2</sub>	Cond. species
Pb	PbS, Pb, PbCl <sub>2</sub>	PbS, Pb, PbCl <sub>2</sub>	Cond. species	Cond. species
Zn	Zn	Zn, ZnCl <sub>2</sub>	Cond. species	Cond. species

### 6.2.8. Conclusions on gas cleaning processes

In a combustion plant, or a gasification or pyrolysis plant with direct combustion of the gas and other products, the contaminants, mainly contained in the waste fuel itself, are transferred to the flue gas from the combustion of the product gas and is eliminated by the commercially and industrially available flue gas cleaning systems. In the case of a gasification process, but excluding direct combustion of the gas, the extent of cleaning required for different applications means that the entire gas cleaning train contains from a few to several process steps, schematically shown in Figure 39.

The IED (and similar regulations outside the EU), which defines combustion, gasification and pyrolysis installations for waste as “incinerators”, regulates substances by limiting emission values (LEVs) that are considered harmful to the environment, see Table 14. Other application than just combustion of the gas has other limitations, see Table 15.

The main treatment for tar, other than by cooling and scrubbing, is by some form of thermal treatment using partial oxidation with air or oxygen and/or plasma energy.

During cooling, tars if still present, and inorganic material evaporated in the gasifier, e.g. alkali chlorides, can condense, and the inorganic species are converted via reactions, e.g. re-carbonisation of CaO. The gas is therefore likely to interfere with indirect heat exchange surfaces by sticking and fouling, so that the design and operating conditions should be selected to avoid major operational problems, such as direct quenching but at the expense of the energy efficiency and heat recovery.

If dry cleaning is preferred, this would be performed at 400 °C by the use of ceramic filters. Sodium bicarbonate injected into the gas at this temperature reacts with HCl and HF which are then separated in the filter as dry sodium salts. This would correspond to some extent of partial form of gas cleaning, where additional flue gas cleaning would be required after gas combustion.

For additional gas clean-up the quenched or filtered gas is then scrubbed to remove strong acids and ammonia in one step or in several steps with varying pH, depending on the balance of acids and bases present in the product gas.

Since many of the heavy metals evaporated in the gasifier would have condensed at these low

temperatures as fine particles or onto other particles present, dry or wet particulate removal is also the main contributor to removal of heavy metals. The cooling and scrubbing also condenses water from the gas to increase the heating value. To further remove liquid and solid aerosols, a wet electrostatic precipitator (WESP) is often proposed. The process condensate separated needs to undergo treatment prior to its discharge. For an application with pressurized gas, the gas would then be compressed. The use of fixed beds of activated carbons and catalysts in the gas cleaning is also favourable for the gas treatment at higher pressure.

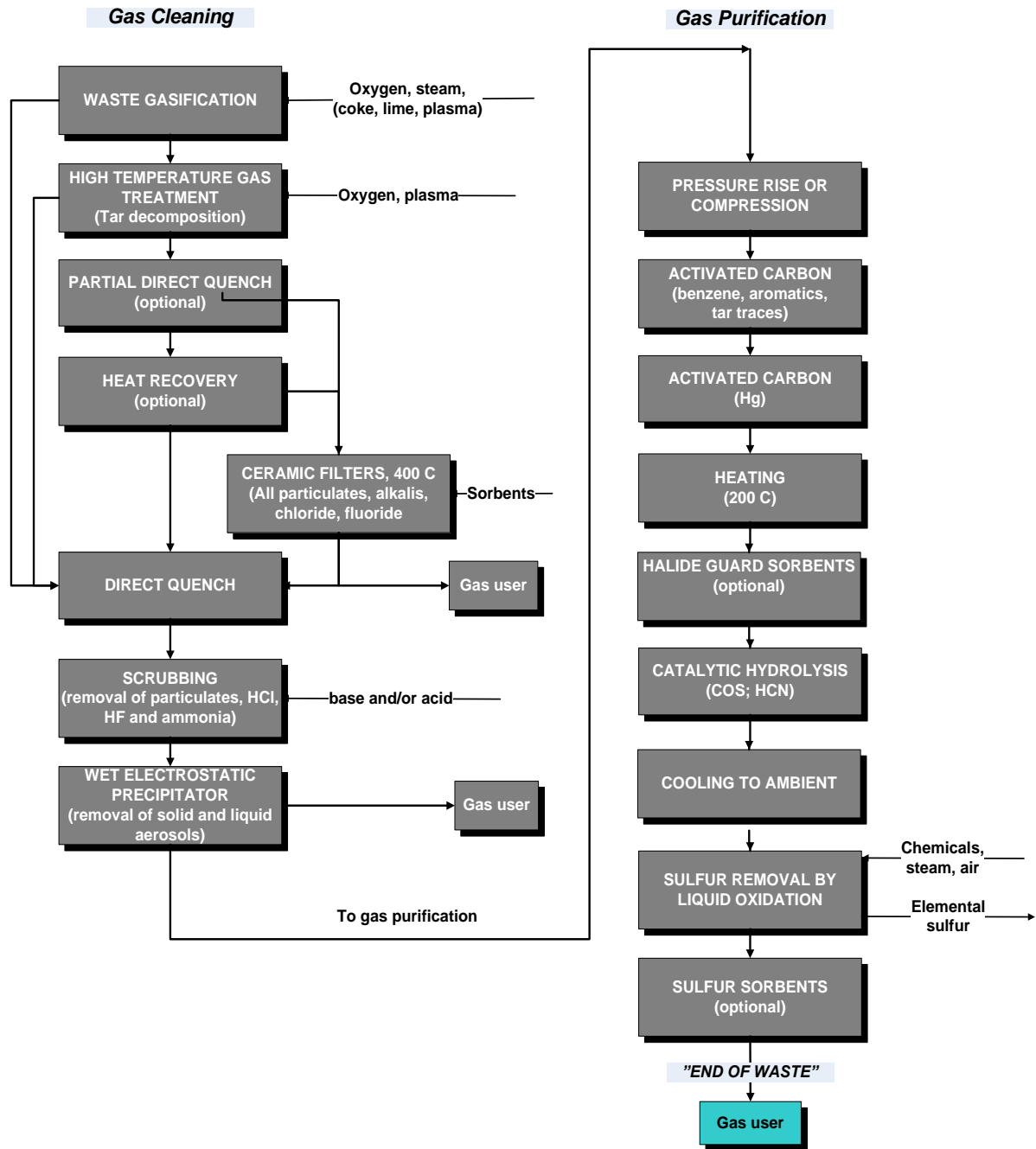

**Figure 39 Gas cleaning process train for waste gasification to clean gas**

The next step would be to apply activated carbon to remove vapor-phase mercury. Traces of hydrocarbons such as benzene, etc. that interfere with the sulphur treatment or other downstream

processes could also be removed by another activated carbon stage.

For sulphur removal, the gas is heated to 200 °C and passes a hydrolysis catalyst. The main effect of this catalyst is to convert COS to H<sub>2</sub>S if the COS content of the gas combined with the H<sub>2</sub>S slip from the sulphur removal is higher than tolerable. The catalyst also hydrogenates HCN, a precursor to the formation of NO. The final treatment is for the removal of H<sub>2</sub>S by scrubbing methods or by sorbents, either selective removal, or for synthesis gas and other applications in combination with CO<sub>2</sub> removal. Such processes are well-known in the chemical industry but have been used to a far lesser degree for waste gasification. The most usually applied technologies for S removal in waste gasification plants include liquid oxidation processes.

From the above, it is evident that the gas treatment is quite costly and adds significantly to the plant investment and operating costs. Nevertheless, cleaning the gas facilitates its use such that other prime movers such as engines and gas turbines can be used to improve the performance over normal incinerators, or instead of energy recovery material recovery by the synthesis of new products can be achieved. In addition, in many industries, e.g. in steel mills, a gaseous fuel is distributed and used at various points in the process. Using a dirty gas with tars which would need control and monitoring of emissions at each of these usage points would not be practical.

### 6.3. GAS CLEANING AND POWER/CHP PERFORMANCE

A JRC review of the state-of-the-art in waste energy conversion by incineration and other methods for energy-generation from wastes<sup>230</sup> notes that the current average efficiency of a waste incinerator to electricity is 22 % (with a potential for reaching 33 %), whereas CHP waste incinerators had an average of 17 % efficiency to power and 68 % overall efficiency (with optimized values of 27 % and 92 %, respectively). At the same time, combustion plants for solids fuels other than wastes reach above 40 % electrical efficiency at larger capacities.

The reason for this relative low efficiency is that the temperature of the superheated steam in a waste incinerator is lower than the 500- 600° C, or even more, that is used for fired boilers using other, cleaner fuels. In Figure 40, the superheated steam temperature in European grate waste incinerators in the period from 1960 to 2010 is shown. The majority of all grate incinerators have steam temperatures in the 390 to 450 °C range, while very few are at higher superheat temperatures, and these are also not very recent installations. At the same time, the steam pressure is most often in the range 4-5 MPa but has recently increased slightly, up to 7 MPa for CFB plants. The reason for this relatively low superheating pressure compared to other power plants, is that the contaminants in waste, and in particular chlorides causes rapid corrosion when these temperatures are exceeded. In CFB boilers, the temperature can go somewhat higher, say 20-30 °C higher, by letting the final superheater be heated in the bed material recirculation loop where no flue gases are present.

The consequences of the low superheat temperature on the electric efficiency for a waste incinerator operating as a condensing plant is indicated in Figure 41. The conservative steam conditions mean that for small plants, the efficiency is only 18 % and can later asymptotically approach 24 % at very high capacities. If instead 7 MPa steam pressure is used, the efficiency ranges from 22 % to 29 %. The red dotted line exemplifies the optimization of the efficiency as larger plants will tend to increase the steam pressure and also sometimes the superheat temperature<sup>231</sup>.

<sup>230</sup> Towards a better exploitation of the technical potential of waste-to-energy. Hans Saveyn *et al.* JRC104013 EUR 28230 EN, 2016-12-12

<sup>231</sup> Some examples: Amager DK, CHP, 440 °C, 7 MPa grate, 2\*105 MWth, 57 MWe gross. Händelö, SE, CHP 450 °C, 6.6 MPa 85 MWth. CFB. Västerås, SE, CHP 476 °C, 7.7 MPa, 167 MWth, 46-51 MWe gross, CFB

However, in the upper right corner, the same estimate is done but using steam pressures and reheat cycles that are typically used for larger power plants, and without raising the superheat temperature from 450 °C, where large power plants would have at least yet another 100 °C higher temperature. The result is that efficiencies of 32 to 35 % are reached and raising the steam superheat temperature would increase the efficiency even further. Some developments strive to accomplish this such as the use of high-alloy clad superheater, positioning of the final superheater in a separate fluidized bed in a CFB return where combustion gases are not present (e.g. Sumitomo Foster Wheeler INTREX superheater, externally heated superheater using fossil gas or a cleaned gasification gas from a small side-stream gasifier (hybrid incinerator) etc.

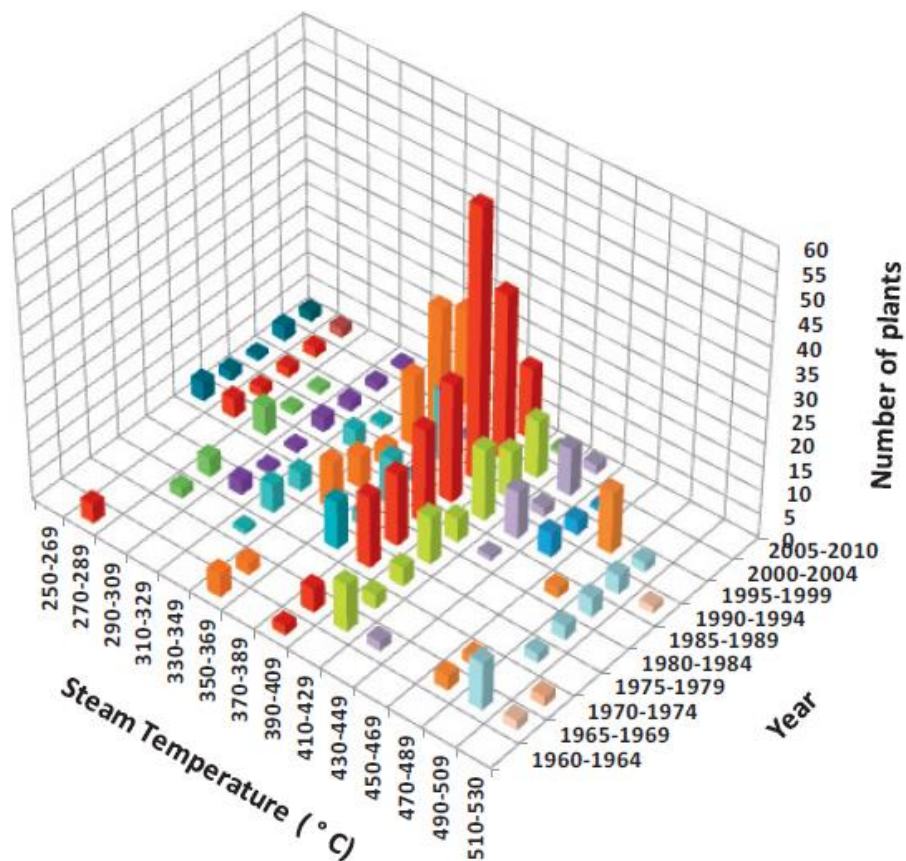

**Figure 40 Steam temperature in European grate fired incinerators<sup>232</sup>**

Since removal of chlorine before combustion is not possible in a waste incinerator, this limitation of the superheat temperature is difficult to overcome, and other improvements are marginal. Thus, gasification with gas cleaning to remove chlorine prior to combustion can remove this limit in the steam temperature. The only example this far, the Kymijärvi II plant, see Section 7.3.2.4, operates at 540 °C, 12 MPa and has a net efficiency of 31 % for CHP operation.

If the gas is cleaned further and cooled, see several examples in Section 7.3.2, it can be used in a gas engine or gas turbine. The cold gas efficiency (i.e. the chemical energy content in the product gas as fed to the prime mover, relative to the energy contained in the solid fuel fed to the gasifier) of gasifiers are typically 75 %, and the gas engine electrical efficiency 35-38 %, such that 26-29 % of the inlet fuel energy is converted to gross power in relatively small plants, say around 10 MW

<sup>232</sup> A preliminary comparative performance evaluation of highly efficient Waste-to-Energy plants  
W. Bogale, F. Viganò. Energy Procedia 45 (2014) 1315 – 1324

thermal. If a bottoming cycle is added to utilize heat recovered from product gas and exhaust gas cooling, another 5-6 % efficiency points can be gained.

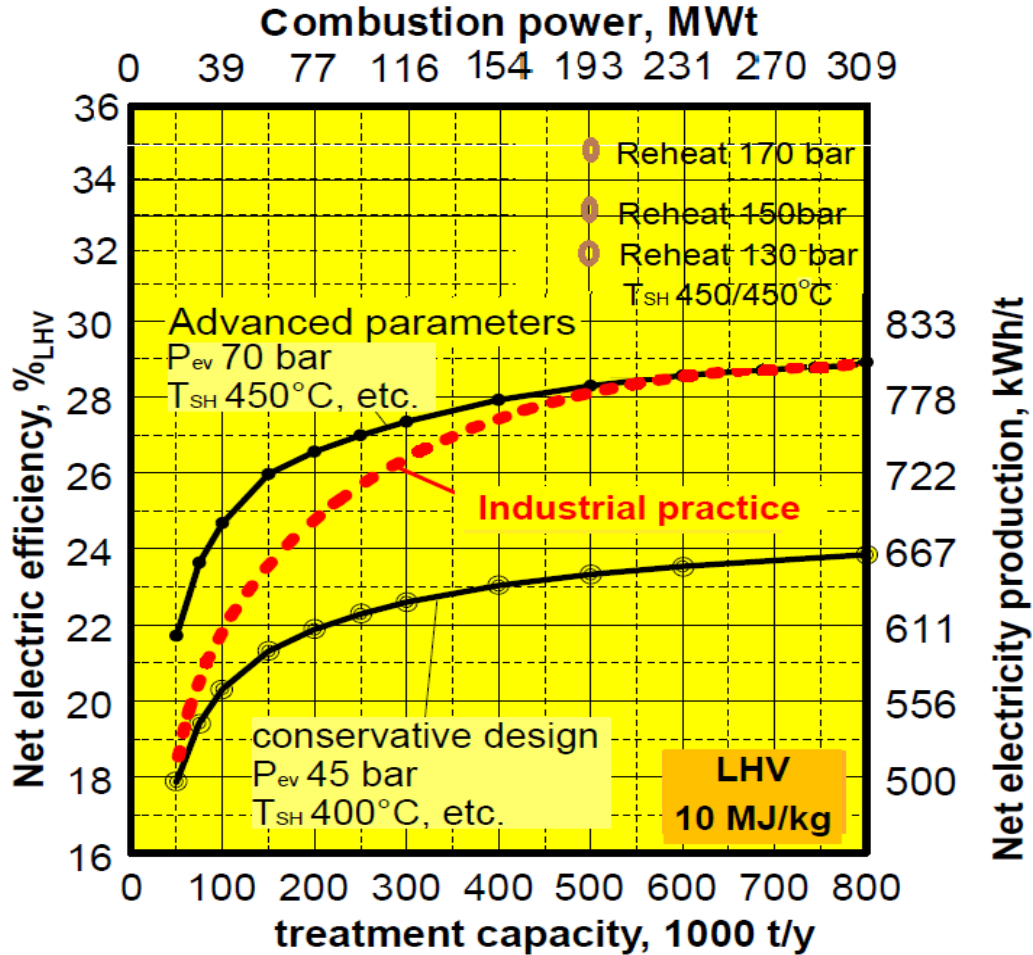

**Figure 41** The performance of WtE plants in relation to design parameters and scale (adapted from<sup>233</sup>)

For a gas turbine, the efficiency is typically 35 %, so that overall 26 % gross efficiency (net electricity relative to the inlet fuel energy) could result. However, gas turbine plants would only be used with a bottoming cycle, i.e. integrated gasification gas turbine combined cycle, and here more heat can be recovered from the gas turbine exhaust gas and at a higher temperature such that combined with heat recovered from gas cooling, another 15 % efficiency points can be raised from the steam cycle, raising the gross generation efficiency to above 40 %.

Thus, gas cleaning is not only a means to avoid operational problems and to meet emission limitations but is also an enabler for using higher steam conditions and prime movers like engines and gas turbines, and thereby raising the overall efficiency far beyond what is possible with a conventional incinerator.

<sup>233</sup> Ultimate energy performances of grate combustor WtE plants. Consonni, S., Viganò, F. & Eremed, W. B. 5th International Conference on Engineering for Waste and Biomass Valorisation (WasteEng 2014), Rio de Janeiro, 25-28 August, 2014.



## 7. Gasifier technologies

In this section, some specific examples of waste gasification technologies and applications are highlighted. The focal points are on industrial use and on installations where gas cleaning is applied. Since there is quite a number of installations, not all have been included, either for lack of information, or due to the fact that some facilities are very similar with each other.

From a technology perspective, this section is organised mainly in the type of applications indicated in Figure 31. From a plant and supplier perspective, Appendix 3 and 4 contain a list of waste gasification plants and projects as well as a list of technology developers and suppliers, respectively. Additional information can be found on technologies and projects, and which can also be used for searching additional information from other sources.

### 7.1. INDUSTRIAL GASIFIERS

In analogy with the gasification of other fuels, gasification of waste has been used to generate fuel gas for industrial purposes.

The main industrial branch using waste gasification is the cement industry. Already the TPS gasifiers built in Greve-in-Chianti, Italy, in the late 1980s were planned to provide a fraction of the fuel gas for a nearby cement plant, in addition to the use of the main part of the fuel gas to gas boilers used to generate electric power.

In the EU, the pioneering Lurgi plant at Rüdersdorf, which was installed in 1996, is still in use, but there have been few followers in the western world. However, the last few years the technology has made large inroads in China as a result of cooperation with Kawasaki of Japan. Apart from the energy recovery, the inorganic, ash, part of the feed can be added as ballast in the cement and thus also this material is recovered and reused for building materials.

In the paper and pulp industry, there are examples of energy recovery by gasification from recycling rejects: the recent ESKA plant in the Netherlands (start of operation in 2016), and the Corenso plant in Finland (in operation since 2001). This latter plant was also specifically designed for metals recycling as aluminium was recovered for reuse. Metals recycling has also been in focus of the ERM plant in the UK, in this case from end-of-life-vehicles shredder residues.

#### 7.1.1. CEMEX Rüdersdorf, Germany

The quarry at Rüdersdorf has hundreds of years of history, and manufacturing of lime and cement also has a long history on the site. Following the unification of Germany, the run-down cement factory was taken over by Readymix AG in the year 1990, and a major modernization project of all parts in the production chain was started. This included the replacement of seven kilns by one kiln that was taken into operation in 1995 to produce 5 000 tonnes/day clinker. As one part of the modernized design, the use of so-called secondary fuels (RDF and other solid and liquid waste fractions) and coal-rich lignite ash was implemented to substitute a significant part of the main fuel, coal.

The process, shown in Figure 42, starts with the preparation of the cement meal, i.e. the milling of a mixture of lime and ballast inerts to a low particle size (right side of Figure 42). The meal is fed to the pre-calciner tower (in the middle of the tower) where the meal is preheated by five cyclone stages in countercurrent flow with the flue gas coming from the kiln and auxiliary burners. This preheats the meal up to 880 °C and also pre-calcines it, thereby reducing the heat load of the kiln

to approximately 40 % of the overall energy load. The meal is then fed into the kiln and is subjected a temperature increase up to 1400- 1500 °C at the kiln outlet, whereby clinkers are formed. These leave the kiln into the clinker cooler (right hand side of the figure). The energy is provided by the auxiliary burners, where also the LCV gas from the gasifier is used, located at the solid inlet of the kiln, whereas the main burner is located at the kiln outlet. Flue gases coming from the first cyclone stage are cooled by heat recovery and cleaned from particulates and other emissions before being sent to the stack.

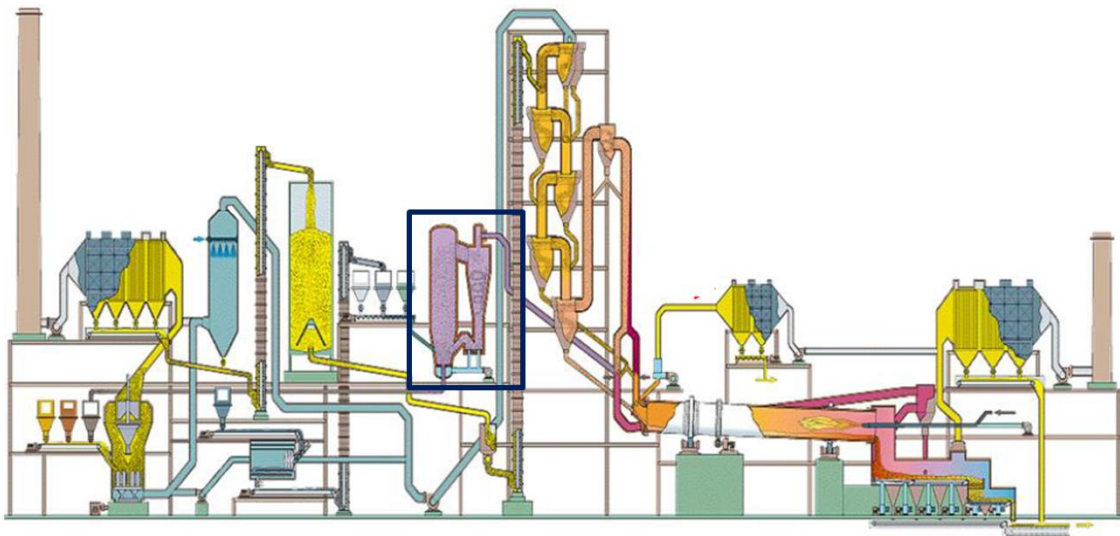

**Figure 42 The CEMEX Rüdersdorf process flow sheet. Adapted from<sup>234</sup>. (the gasifier is highlighted by the blue rectangle)**

Some of the secondary fuels, e.g. waste oil, high energy value fluff (SLF) and meat and bone meal (MBM), are fed to the main burner at the hot, outlet, end of the kiln, where also coal is used. Some are also fed to auxiliary burners at the cold, inlet, end of the kiln and provides preheat in the pre-calcination tower, e.g. fluff (SLF), MBM, sewage sludge and the gasifier LCV gas. However, the main fraction of secondary fuels is fed to a CFB gasifier together with lignite ash and the product gas goes to the auxiliary burner. Overall, the energy cement plant consumption amounts to approximately 200 MW, whereas the design thermal capacity of the gasifier is 100 MW.

The CFB gasifier was installed in 1996 by Lurgi and has throughput up to 30 tonnes/h of fuels and 25 tonnes of carbon-containing ash material to reach 100 MW, depending on the energy content of the feedstocks. The feedstock, a variety of RDF materials such as SLF, paper waste, RDF, plastic waste, dried sludges, etc., and lignite ash with a high carbon content, must meet certain requirements, see Table 21, in terms of particle size, and other properties. However, as can be seen from the table, the range in properties can be rather wide for individual feeds, and by mixing sufficient heating value and output is achieved.

The gasifier input material is fed by several silos that can hold different materials (e.g. RDF, mineral residues, dry ash, etc.) to be fed to the gasifier in various ratios, depending on the fuel heating value and other parameters. The RDF is fed to the gasifier via a screw located about 2 m above the nozzle grid. The lignite ash is fed to the loop seal in the cyclone return leg. Initially there was also a

<sup>234</sup> Nutzung von industrieller Abwärme im Zementwerk Rüdersdorf . Michael Müller-Pfeiffer. 6. Brandenburger Wirtschaftstag, IHK Potsdam, Juni 13, 2012.

pneumatic feeding directly into the gasifier<sup>235</sup>.

The gasifier is air-blown using preheated air, primary air is routed via the nozzle grate and secondary air is fed in separate nozzles. The air is delivered by Root's blowers and secondary air is preheated directly in contact with the ash while the primary, which due to the nozzle grate must be free from dust is indirectly heated in the ash cooling.

**Table 21 Main data of the gasification process at CEMEX Rüdersdorf<sup>236,237</sup>**

Gasification Reactor		Process Data	
Diameter	3.5 m	Gasification agent	Air
Total height	23.5 m	Thermal capacity	100 MW
Grate area	2.3 m <sup>2</sup>	Feed flow	20–30 tonnes/h
Gas pipe length	50 m	Gasifier temperature	900–960 °C
Properties Input Material		Gas flow	62,000 m <sup>3</sup> N/h
RDF	Lignite ash	Gas LHV	3–5 MJ/m <sup>3</sup>
SLF, plastic and paper waste, RDF, tar sludges, roofing paper etc. free from oversize and metal pieces etc.	High carbon ash residues	Temperature gas	900–950 °C
Particles < 100 mm, 30 * 10 * 5 mm, max. side 50 length mm, Fines < 0.5 mm limited	Particles < 6mm, Fines < 0.5 mm limited	Residence time, gas	4 s
Moisture content < 50 %, limitation by energy balance		Mass flow residue	< 12 tonnes/h
Ash limited by energy balance		C in ash residue	< 1.5 %
LHV 1–35, typically 14 MJ/kg	LHV < 6 MJ/kg		
Bulk density > 300 kg/m <sup>3</sup> desired			

In the circulating fluidized bed gasifier, the organic fraction of the input material is converted to an LCV product gas and is thus separated from the bulk of the inorganic fraction of the input materials.

The solids-gas suspension leaving the gasifier at the top passes the recycle cyclone and the separated solids are returned to the gasifier bottom via a seal pot, into which also input materials can be fed. The gas leaves the hot gas cyclone and is transferred to the cement kiln calciner through an unheated hot gas pipe of 50 m length. One effect of shifting the energy input from coal in the main burner to LCV gas in the pre-calciner is that the NO<sub>x</sub> emissions were reduced significantly.

After the reactions in the gasifier, the ash/inorganic residues hold less than 1.5 % carbon and are removed via a rotary valve at the gasifier bottom into a fluidized bed ash cooler, where secondary air is preheated directly and primary air via a heat exchanger. Any coarse particles in the ash cooler which may hamper the fluidization of the ash can be discharged through a cooling screw. The cooled solid residues are sent to the raw meal mill for use as ballast in the cement.

The development in the overall use of secondary fuels in the plant is shown in Figure 43. At present,

<sup>235</sup> Operational Results from Gasification of Waste Material and Biomass in Fixed Bed and Circulating Fluidised Bed Gasifiers. C. Greil et al. The Clean Choice for Carbon Management, Noordwijk, NL, 2002

<sup>236</sup> Einsatzmöglichkeiten für gefährliche Abfälle im Zementwerk Rüdersdorf. Uta Tietze. Thermische Verfahren der Abfallentsorgung im Spannungsfeld zwischen Entsorgungssicherheit und Klimaschutz. SBB und der IHK Potsdam. 20. Januar 2010.

<sup>237</sup> Status of Alternative Techniques for Thermal Waste Treatment. Peter Quicker et al. Project No. Z 6 -30 345/18. Report No. 29217. The Federal Environmental Agency (Germany). June 2015

the overall use of secondary fuels constitutes 70 % of the energy requirements. The use of secondary fuels in the gasifier is approximately 180 000 tonnes/year, and an additional 20 000 tonnes per year of ash residues are treated in the gasifier (i.e. 200 000 tonnes out of a total of 260 000 tonnes of secondary fuels and materials used per year in all firing points). This constitutes around 70 % of the secondary fuel usage both in mass and energy terms. In the first few years, during the commissioning, wood fuel was used as the main fuel, but secondary fuels have since completely taken over for economic reasons.

The gasifier plant has also been modernized to increase the waste fraction and the reliability. In 2011 the air injection system and grate were modified by Outotec<sup>238</sup> to improve ash flow, and work is ongoing to enhance metal recovery from the gasifier ash.

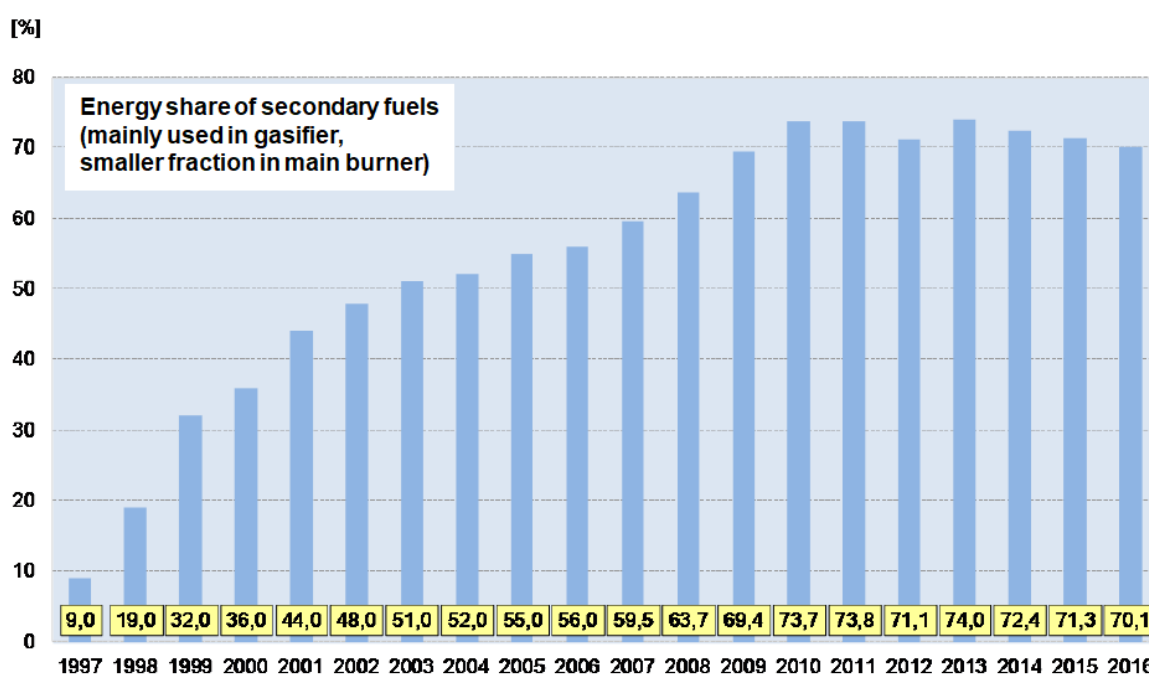

**Figure 43 The share of secondary fuel energy at CEMEX Rüdersdorf (Adapted from<sup>239</sup>)**

### 7.1.2. Anhui Conch Kawasaki Engineering Co., Ltd., China

A similar technology is based on the Kawasaki fluidized bed gasification technology developed for waste gasification-direct ash melting<sup>240</sup>, which is not described in this report but listed in Annex 4.

Unsorted waste or RDF is “gasified” at low temperature (less than 600 °C) in a fluidized bed furnace. The gas, unburned substances and fly ash from the gasification furnace, instead of being sent to a melting furnace and burned at high temperature as in the case of waste gasification-direct ash melting, are routed to the pre-calciner of a cement plant, as seen in Figure 44. In this case the bottom ash is typically not suitable for use in the cement kiln due to its high content of metals, unless the waste has been pre-treated sufficiently well.

Based on the joint research with Chinese partners, a verification test facility (300 tonnes/day) was constructed in Tongling Conch Cement Co., Ltd. and operated from March 2010 onward using municipal waste. The results were good, the cost of fuel was reduced while the quality of the

<sup>238</sup> Plant Portrait. CEMEX – Rüdersdorf. Outotec GmbH.

<sup>239</sup> Aktualisierte Umwelterklärung. CEMEX Zement GmbH November 2017

<sup>240</sup> [https://global.kawasaki.com/en/industrial\\_equipment/environment\\_recycling/waste/heat.html](https://global.kawasaki.com/en/industrial_equipment/environment_recycling/waste/heat.html)

cement was maintained, and waste disposal was achieved for the local community.

Since 2010 over 20 fluidized bed waste gasification plants have been installed in cement plants in China in the capacity ranges of 200-400 tonnes/day (approximately 30-80 MW<sub>th</sub>)<sup>241</sup>.

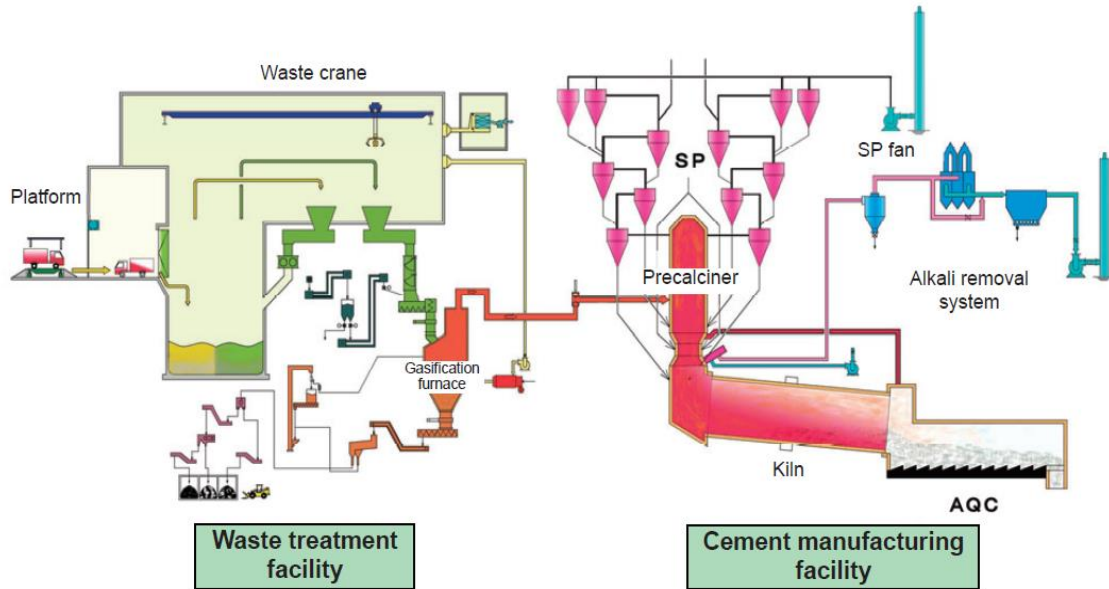

**Figure 44 Anhui Conch Kawasaki Engineering gasification process<sup>242</sup>**

### 7.1.3. Vicat, Crechy, France

The French cement supplier Vicat (a family-owned company named after Louis Vicat, who invented artificial cement in 1817) is number seven among the consolidated cement manufacturers worldwide, and number three in France. Based on developments over seven years, leading to a patent<sup>243</sup>, the company has developed a gasifier, Figure 45, for the purpose of expanding the use of secondary fuels in the cement calcination furnaces.

A 3 ton/h gasifier has been installed during 2017 as a pilot project at Vicat's Crechy cement plant in France, and after testing it will come into regular operation in 2018, thereby reducing the fossil demand by 6-10 %, and where the plant has already substituted up to 80 % of the fossil fuels by tyres, wood residues, sludges, etc. The cost of the gasifier is 4.5 million €, a part of which is through support from the French agency Ademe<sup>244,245</sup>.

The gasifier will use wood residues and RDF to generate a gas at 800 °C for use in the pre-calciner. The gasifier ash will be used as ballast in the cement meal. The patent description is very general, so the details of the process are not known, neither whether it includes some form of gas cleaning for removal of sulphur or chlorine. Since the cited articles refers to an advantage of the gasifier in being able to take larger size of feedstock, 2-20 cm, while the direct injection into the kiln is limited to below 30 mm, one could infer that this is probably a fixed bed.

<sup>241</sup> Press releases at <https://global.kawasaki.com/en/corp/newsroom/news/index.html?year=&category=>

<sup>242</sup> Waste Treatment Systems Using Cement Kiln. F-25. <https://www.jase-w.eccj.or.jp/technologies/index.html>

<sup>243</sup> EP 2 633 004 B1

<sup>244</sup> <http://www.vichy-economie.com/revue-presse-vichy/vicat-investit-a-crechy>

<sup>245</sup> [https://www.lamontagne.fr/crechy/economie/btp-industrie/2018/01/30/la-cimenterie-de-crechy-allier-en-cinq-chiffres\\_12712714.html](https://www.lamontagne.fr/crechy/economie/btp-industrie/2018/01/30/la-cimenterie-de-crechy-allier-en-cinq-chiffres_12712714.html)

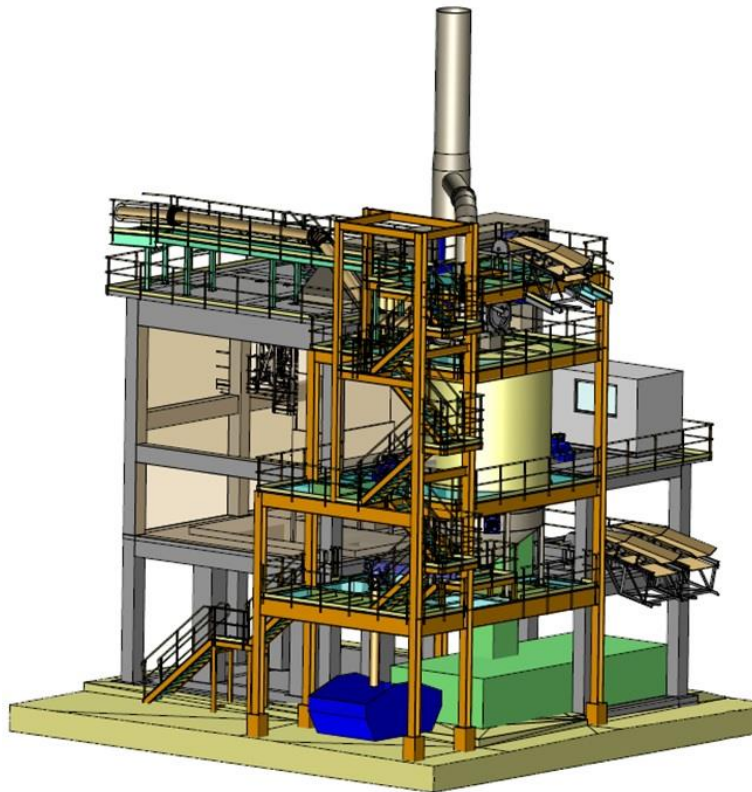

**Figure 45 Vicat gasifier installation<sup>246</sup>**

#### **7.1.4. ESKA, the Netherlands**

Eska Graphic Board B.V. is a producer of high-quality solid board, sold to over 90 countries. 100% recycled paper is used to produce over 250 000 tonnes per year of graphic board in its two state-of-the-art plants in Hoogezand and Sappemeer, both located in the Groningen province of the Netherlands.

During the pulping process of the recycled paper non-digested residues composed of mainly waste paper and plastics are produced, known as rejects that have been disposed of at a third-party incinerator<sup>247, 248</sup>. Simultaneously, the heat for the manufacturing process is provided by saturated steam produced by gas-fired steam generators. At the turn of the century, the ESKA started to develop ideas of using the rejects to replace the natural gas for the production of the process steam, and thereby reduce the cost for natural gas and for waste disposal, as well as reduce the carbon footprint. Over the years, several studies of different options were made for the Hoogezand plant. In 2010, the plans had been developed to a state where a grant had been approved by RVO (Netherlands Enterprise Agency) and in 2011 a permit application was made. Although the province gave the permit in 2013, there were several appeals that prolonged the permitting process to 2014<sup>249</sup>. Meanwhile, ESKA had structured the project and contacted potential EPC suppliers. When the final permit was granted by the State Council in the beginning of 2014, negotiations were started resulting in that ESKA signed a contract for the plant construction with Leroux Lotz

<sup>246</sup> <http://www.berkes.com.uy/en/news/122-energy/4120-gas%C3%B3geno-de-rdf-en-francia-2.html>

<sup>247</sup> <http://www.lerouxlotz.com/contrat-de-construction-dune-unite-complete-de-gazeification/?lang=en>

<sup>248</sup> ESKA GRAPHIC BOARD B.V., HOOGEZAND [NL]. 12 MWth Waste Paper Rejects Gasification System. LLT project review

<sup>249</sup> Vergassing rejects. Jan-Willem Hoogerdijk, Internationaal Innovatie-Evenement Papier- En Kartonketen. KCPK. Doorwerth 3 Februari 2016

Technologies (LLT) of France of a value of 14.5 million € in early 2015<sup>250</sup>.

LLT is a thermal engineering company supplying boilers, incinerators, etc., which had procured the IPR of TPS of Sweden in 2010. This meant that the plant was modelled<sup>251</sup> on the 2\*15 MW<sub>th</sub> TPS plant at Greve-in-Chianti<sup>252</sup>, Italy, which was operated until 2004.

The reason for the lengthy permitting process was that the ESKA plant site, Figure 46, is locked in with little space available for new installations, and with restrictions on building height, traffic and noise, within a mainly residential area and also neighbouring railway. The handling of rejects and the gasifier processing being a novelty, was met with some resistance in the surrounding area.



**Figure 46** The ESKA site<sup>249</sup>

This also resulted in that the permit conditions, Table 22, are significantly stricter than what the IED<sup>253</sup> stipulations for an incinerator, see Table 14 and Annex 3.

The plant, Figure 47, consists of the following sections:

- Fuel preparation (crane, shredder, magnetic + non-magnetic separator)
- Storage & dosing (reclaim system, conveyors and surge bin)
- Gasifier (3.5 ton/h, equivalent to 12 MW<sub>th</sub> CFB, air-blown)
- Syngas combustion system (LCV gas, natural gas)
- Heat recovery steam generator (1.6 MPa saturated steam)
- Flue gas treatment system

<sup>250</sup> ESKA and LLT press release, 2015-02-11.

<sup>251</sup> CFB Gasification of Biomass and Waste at Pilot and Commercial Scale. Timothée Nocquet, Tudor Florea, Charlotte Marty, Mazen Al Haddad. 69TH IEA – FBC Meeting, 26th of September 2014

<sup>252</sup> Case Study on Waste-Fuelled Gasification Project Greve in Chianti, Italy. IEA Bioenergy Agreement—Task 36. D.L. Granatstein, Natural Resources Canada/CANMET Energy Technology Centre (CETC). June 2003.

<sup>253</sup> Industrial Emissions Directive 2010/75/EU

The plant processes 25 000 tonnes of reject per year (3.5 tonnes/hr) or the equivalent of nominal capacity of 12 MW thermal. The gas is directly used in a steam boiler to produce 16 bar saturated steam. The overall efficiency is 85 % and the rejects replaces 18 000 Nm<sup>3</sup> of natural gas per year (equivalent of 11 000 household consumers).

**Table 22 ESKA plant limiting emissions values in the permit<sup>249</sup>**  
**(note: reference is 6 % O<sub>2</sub>, not 11 % as in the IED)**

Component	Maximum stack emission mg/Nm <sup>3</sup> (at 6 % O <sub>2</sub> , 24 h average)
NO <sub>x</sub>	150
SO <sub>2</sub>	33.3
Total dust	5
CO	45
C <sub>x</sub> H <sub>y</sub>	12
HCl	10
HF	1
Sum heavy metal	0.15
Cd+Tl	0.015
H <sub>g</sub>	0.02
NH <sub>3</sub>	5

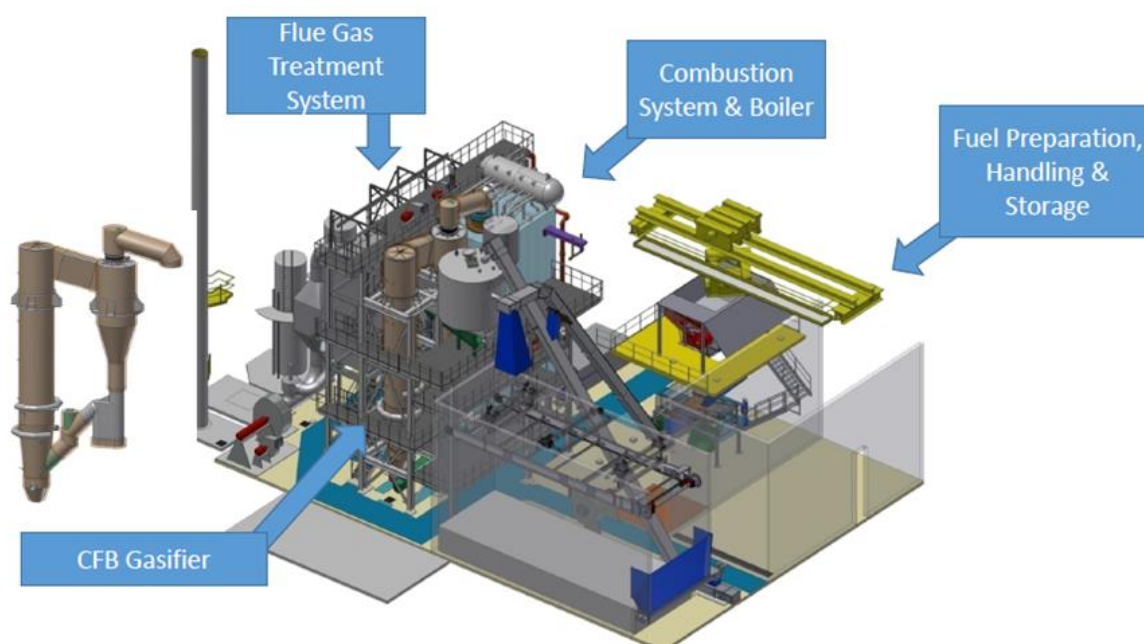

**Figure 47 The ESKA gasification facility installed by LLT (Adapted from<sup>249</sup>)**

The installation was completed by mid-2016. Some of the experiences during the commissioning was dusting from the shredders, that the bulk density of the shredded fuel was lower than anticipated and this caused feed capacity limitations, and that also ash handling needed improvements to cope with the fly ash quantities experienced. Following adjustments, the plant passed the acceptance test.



in June 2017. Some more recent operational data were presented in 2018<sup>254</sup>.

#### **7.1.5. Innovative Environmental Solutions, UK**

Chinook Sciences, Cranford, New Jersey, USA, was founded in 1998, and has developed the RODECS<sup>®</sup> gasification system which is said to be in its ninth design generation. The RODECS system is claimed to be capable of processing a wide range of waste streams. In particular, it appears to be used to recover metals from mixed wastes such as e.g. ASR (auto-shredder residues) and aluminium-containing wastes. The company claims that the process has been installed at 17 sites worldwide, but it has not been possible to identify more than a site in Pennsylvania, a scrap de-lacquering plant in Congleton<sup>255</sup>, Cheshire and the IES site in Oldbury, see below<sup>256</sup>.

In the UK, Chinook Sciences and European Metal Recycling (EMR), the largest metal recycler in the UK formed a JV, Innovative Environmental Solutions UK, Ltd. in 2009 to develop recovery plants for ASR. The first plant is located at Oldbury, West Midlands, UK in the vicinity of an ERM autoshredder plant. The Oldbury plant has a capacity to treat 350 000 tonnes per year<sup>257</sup>, of which some 190 000 tonnes per year of SRF (shredder residues fines) will be treated in two parallel Rodecs lines with two 100 m<sup>3</sup> RODECS gasifiers per line in the gasification system<sup>258</sup>. The plant, which went into operation in 2015 produces 40 gross and 32 net MW<sub>e</sub><sup>259</sup>.

The process<sup>260</sup>, see Figure 48, consists of two RODECS<sup>®</sup> batch gasifiers, each holding a volume depending on capacity of 2 to 100 m<sup>3</sup> and capable of processing approximately 0.1 tonne/m<sup>3</sup>, hr. The RODECS<sup>®</sup> system will have a natural gas fired thermal reactor to supply the primary heat for the gasification process.

---

<sup>254</sup> Reject gasifier ESKA. BTX co-production (ESKA-ECN ESKAGAS project). A.J. Grootjes. IEA Bioenergy Task 33 –Workshop on Waste gasification. ECN, part of TNO, Petten May 8th, 2018.

<sup>255</sup> <http://andrewtonge.com/Tandom/index.html>

<sup>256</sup> The company refers to installation in the USA etc. but without giving a reference list. One plant is at Hollidaysburg, PA. There are press releases on two contracts for aluminum recovery plants in Turkey, but if these were completed is not clear. There is also press release regarding a contract in UAE, but this project has apparently been discontinued by the UAE client.

<sup>257</sup> <http://www.chinooksciences.com/innovative-environmental-solutions-begins-construction-on-the-worlds-largest/>

<sup>258</sup> <https://www.letsrecycle.com/news/latest-news/emr-plans-recycling-and-gasification-plant-in-midlands/>

<sup>259</sup> Draft Permit. Innovative Environmental Solutions UK Limited, IES – Oldbury. Permit number EPR/GP3739VR. Environment Agency (UK)

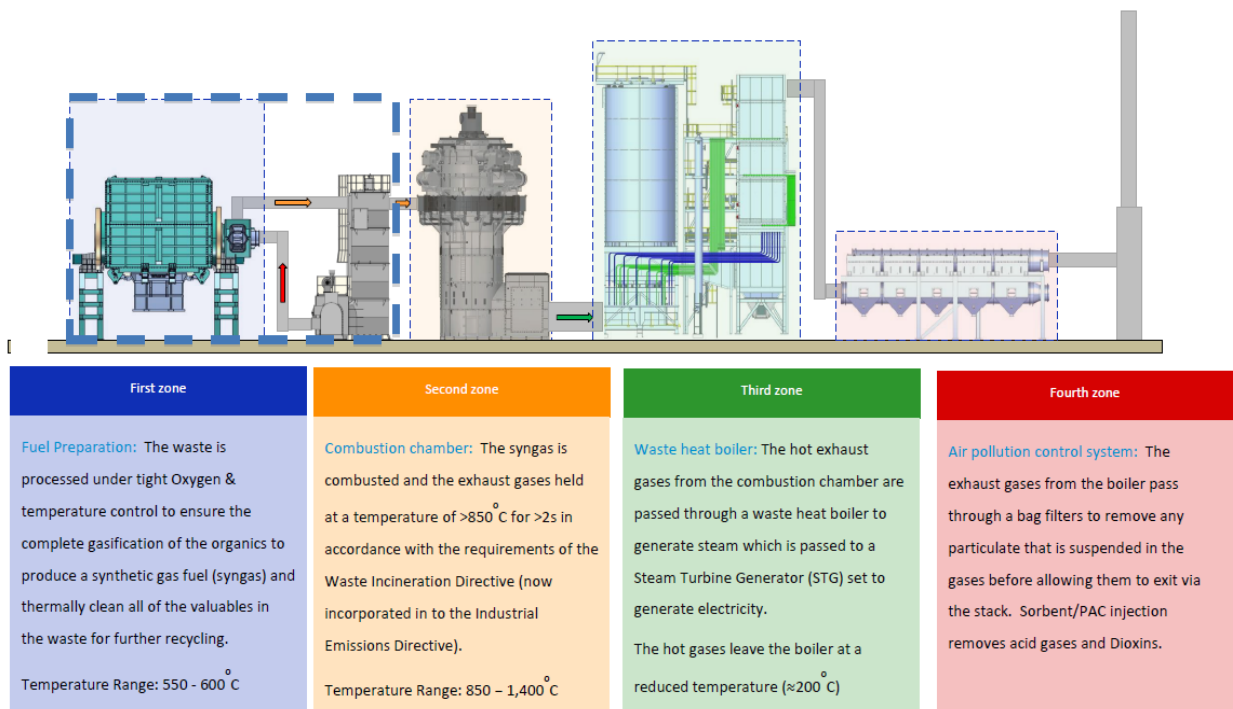

**Figure 48 The RODECS gasification system<sup>260</sup>**

The waste feedstock, which has already been subject to recycling, is fed, using a grabber system, into one of the two RODECS<sup>®</sup> gasifier bins. The bin will be positioned in the filling area using an automated trolley car system with two bin location stands. The waste will be loaded into the bin and be compressed regularly during the filling to allow more waste to be added to the bin. This process will continue until the bin reaches its target weight and loading stops. Then, the trolley will move the filled feed bin to the RODECS<sup>®</sup> to the adjacent position of the processed bin. The processed bin is then unlatched from the RODECS<sup>®</sup>, and the trolley moved into a position such that the fresh feed bin is in place to be latched to it. After the fresh bin has been attached, the RODECS<sup>®</sup> will then rotate 180 degrees so that the bin will be inverted at the top, starting the process cycle. Changing bins will be accomplished in approximately three minutes.

The syngas is generated in the RODECS<sup>®</sup> processing chamber through a combined action of pyrolysis and gasification. The rate of reaction is controlled by an array of controlled parameters (flow, temperature, oxygen-level, etc.). The temperature inside the gasifier (550 – 600°C) is maintained below the melting temperatures of metals enabling them to be recovered. The rate at which the bin content is heated is determined by the process chamber movement, volume of gases and temperature of the recycled hot gases sent to the RODECS<sup>®</sup> from the thermal reactor chamber. The preheated gases provide sensible heat required for heating and are also used to fluidise the feed to enhance the rate of production of the syngas.

The remaining material, metal, glass, dirt and sand, is mechanically retained inside the RODECS<sup>®</sup> processing chamber. At the end of the batch processing, the RODECS<sup>®</sup> will be rotated such that the bin is back at the bottom with the inert materials falling back into the bin for removal. The bin will be unlatched, and the remaining contents is taken to the process material separation area and sent for further reprocessing/recycling.

The total cycle time is approximately 120 minutes for a 100 m<sup>3</sup> bin. The time required reaching

<sup>260</sup> Proposed energy generation facility at London Sustainable Industries Park, Choats Road, Dagenham, Essex, RM9 6LF. Environmental Statement. Thames Gateway Waste to Energy Ltd. December 2013

threshold syngas production is expected to be in the region of 25 minutes. The cool down time before unlatching the bin, from the time when the average syngas production rate has declined below a threshold value to the complete depletion of syngas, is expected to take 10 to 15 minutes. The bin will only unlatch after full depletion of the syngas.

The syngas produced in the gasifier passes to a dedicated natural gas fired combustion chamber where it is combusted, and the exhaust gases held at a temperature above 850 °C for longer than 2 seconds. For NO<sub>x</sub> control, a Selective Non-Catalytic Reduction (SNCR) system is employed utilising ammonia solution. The exhaust gases from the combustion chamber are passed through a waste heat boiler to generate steam for the steam turbine generator.

Exhaust gases exit the waste heat boiler at 200 °C and are drawn through an air pollution control system which consists of a bag particulate filter that utilises bag filters where sodium bicarbonate sorbent and PAC are injected to reduce acid gases. The flue gases are sucked through the system by an induced draft fan and discharged via a stack.

The technology is also being considered for an ASR application outside of Liverpool and for a WtE facility at Dagenham, London with one line of RODECS gasifiers where it will be fuelled by RDF to generate power.

#### **7.1.6. Stora Enso (*fka* Corenso United), Finland**

The gasifier at Corenso United Oy<sup>261,262</sup>, see Figure 49, was originally linked to a recycling process for used liquid cartons (e.g. juice containers). The fibre from the used liquid packages was recycled into coreboard production. The gasifier plant utilises plastics and aluminium-containing reject material as feed material. The combustible material, mainly fibres and PE plastic coating, is gasified at relatively low temperature with air at 600 °C- 700 °C in a stationary fluidized bed gasifier. The relatively low temperature in combination with the reducing character of the product gas avoids the oxidation of the aluminium foil in the gasifier. Instead, the aluminium is separated from the gas together with other solids in a cyclone and recycled for secondary aluminium production. The product gas is combusted in a steam boiler thereby replacing fuel oil consumption in the power plants of Stora Enso in Varkaus.

---

<sup>261</sup> Review of Finnish biomass gasification technologies. E Kurkela. OPET Report 4. OPET Finland. VTT 2002

<sup>262</sup> Status report on thermal biomass gasification in countries participating in IEA Bioenergy Task 33 2016. Jitka Hrbek, Vienna University of Technology, Austria, April 2016

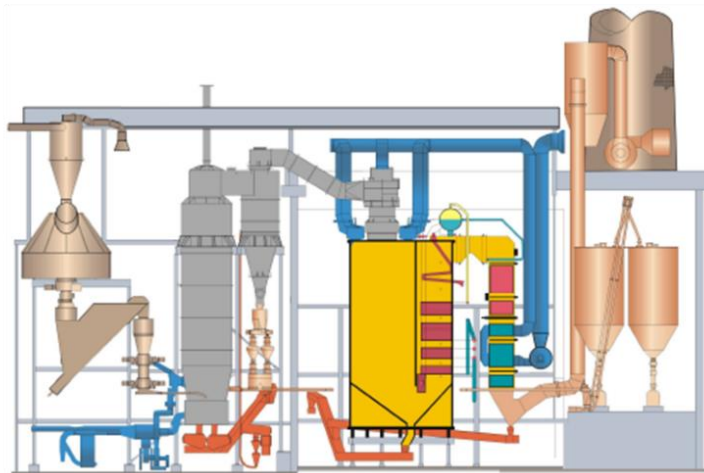
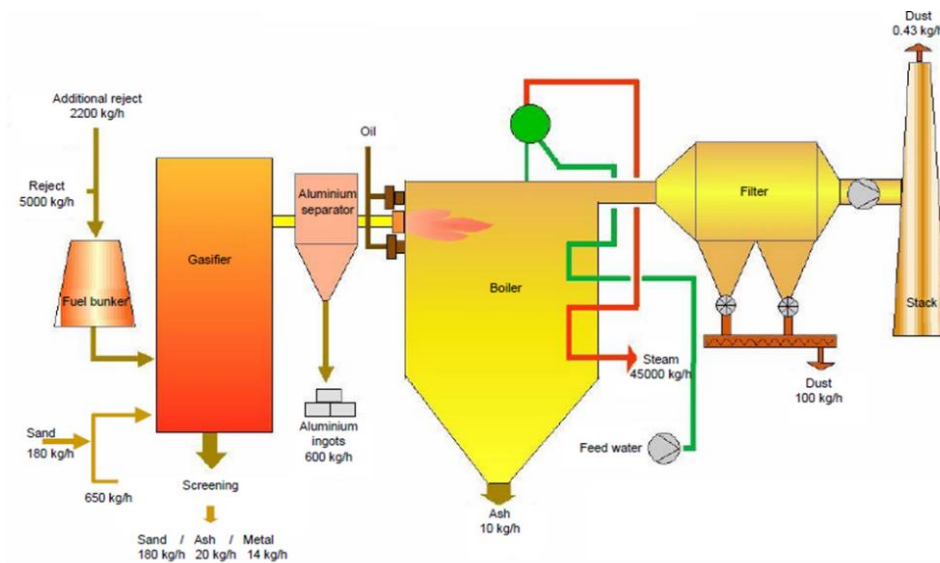

**Figure 49 The Stora Enso Ecogas plant at Varkaus, Finland<sup>261, 262</sup>.**

The 50 MW<sub>th</sub> ECOGAS gasifier plant, generating a product gas input to the boiler of 40 MW<sub>th</sub>, was developed by VTT and SHI FW (*fka* Foster Wheeler Energia Oy). It was taken into operation in 2001 and was reported<sup>263</sup> to cost 20 million €. The ECOGAS plant has been operated commercially by Corenso (a JV between Stora Enso and UPM) until 2010, when the recycling process was moved to Pori, and since then by Stora Enso Varkaus mill<sup>264</sup>.

## 7.2. CO-FIRING FOR POWER AND HEAT

### 7.2.1. Essent/RWE AMERGAS, The Netherlands

Essent/RWE owns and operates the Amercentrale in Geertruidenberg, the Netherlands. The plant has two coal-fired main facilities, Amer 8 of 645 MW<sub>e</sub> and 250 MW<sub>th</sub> and Amer 9 of 600 MW<sub>e</sub> and 300 MW<sub>th</sub>. To reduce the CO<sub>2</sub> emissions while also benefitting from the MEP support (Subsidy for environmental quality of electricity production), and apart from the gasification plant described below, the Amer 8 and 9 units use up to 300 000 and 600 000 tonnes/year, respectively, of biomass by direct co-firing. Thus, this direct co-firing provides 17 %/100 MW<sub>e</sub> and 27 %/166 MW<sub>e</sub> of the

<sup>263</sup> Ingenieur.de 2002-02-01. <https://www.ingenieur.de/technik/fachbereiche/druck/recycling-im-karton/>

<sup>264</sup> Country report Finland. Juhani Isaksson, Valmet. IEA Task 33 meeting, May 2018 Alkmaar, NL

nominal electrical output of the two stations<sup>265</sup>. These installations have been installed over the period 2003-2005.

Before the direct co-firing was initiated, indirect-co-firing was installed in 1999-2000 by means of a waste wood gasifier which was built to be connected to Amer 9<sup>266</sup>. The Amer 9 unit is of a forced once-through supercritical type with 4 burners per layer, 6 burner layers for pulverized fuel (coal or biomass), 1 burner layer for fuel gas from the waste wood gasification. The unit produces 600 MW<sub>e</sub> at 42 % efficiency.

The gasifier was designed to use 150 000 tonnes/year of non-recyclable, low quality demolition wood, denominated waste wood category B in the Netherlands. Category B reflects that it contains painted wood, MDF, plywood as well as glass, metal and other inorganic materials<sup>267</sup>. The fuel has a moisture content below 20 wt.% and is pre-treated by size reduction to < 50 mm. The specific cost<sup>266</sup> of the installation was 1 300€/kW<sub>e</sub> and the equivalent output 34 MW<sub>e</sub>, i.e. a total cost of 44 million € and 5 % of the boiler output.

The prepared waste fuel is then processed in a circulating fluidized bed (CFB) of a capacity of 85 MW<sub>th</sub> and at near-atmospheric pressure based on the Lurgi technology<sup>268, 269, 270, 271</sup>, i.e. the same supplier as for the Cemex plant, see Section 7.1.1. The gasifier fluidizing medium is preheated air and steam which is fed as primary and secondary air with a 1:1 split. and the operating temperature is approximately 850°C.

After the bed material recovery cyclone at the gasifier exit, the gas is cooled in a water-tube type cooler producing 310°C superheated steam and having evaporator, superheater, evaporator and economizer sections in the flow direction of the gas.

In the original design, Figure 50, the fuel gas was cooled to approximately 200 °C, and then cleaned at low temperature by particulate removal in a bag filter and by several stages of scrubbing to remove halogens, tars and ammonia, after which the clean fuel gas (5 –6 MJ/Nm<sup>3</sup>) was to be routed to the specially designed low calorific gas burners of the boiler at 95 °C. An advantage of this concept is that the not only coarser particulates but also the main part of the fuel-based contaminants are separated from the fuel gas before entering the coal-fired boiler. Thereby alkali-induced fouling, chloride-induced corrosion and NO<sub>x</sub> formation from ammonia in the gas can be avoided and the fuel specification can be broader.

During commissioning of the gasifier in 2000, several operational issues were identified such as fuel quality issues, bottom ash blockages, agglomeration tendencies in the gasifier, rapid gas cooler fouling, ignition of high carbon content fly ash in the gas cooler and the bag filter during start-up and wear in the wet scrubbing section from solids, which in combination limited the operational hours of the plant.

---

<sup>265</sup> Essent's Biomass Activities – Drivers. Roger Miesen, Essent Biomass Conference 2009, Geertruidenberg November 4 -5, 2009

<sup>266</sup> Amer #9, Essent, Geertruidenberg, the Netherlands. <http://www.ieabcc.nl/database/info/cofiring/91.html>

<sup>267</sup> Biomass gasification in the Netherlands. Bram van der Drift. ECN-E--13-032, ECN, July 2013.

<sup>268</sup> Amer Gasifier: Process redesign, operational results and developments for alternative fuels. Wim Willeboer. SGC International Gasification Seminar, Malmö 2014

<sup>269</sup> Consequences of the coal covenant for Essent: co-firing and co-gasification. A. van Disseldonk, M. Spanjers. VBG Powertech 9, 2006

<sup>270</sup> Essent's wood gasifier project and process re-design. Wim Willerboer. Essent Biomass Conference 2009, Geertruidenberg November 4 -5, 2009

<sup>271</sup> Wood gasifier AC 9 Operational experience 2007-2009. Fred Hooijmaijers Essent Biomass Conference 2009, Geertruidenberg November 4 -5, 2009

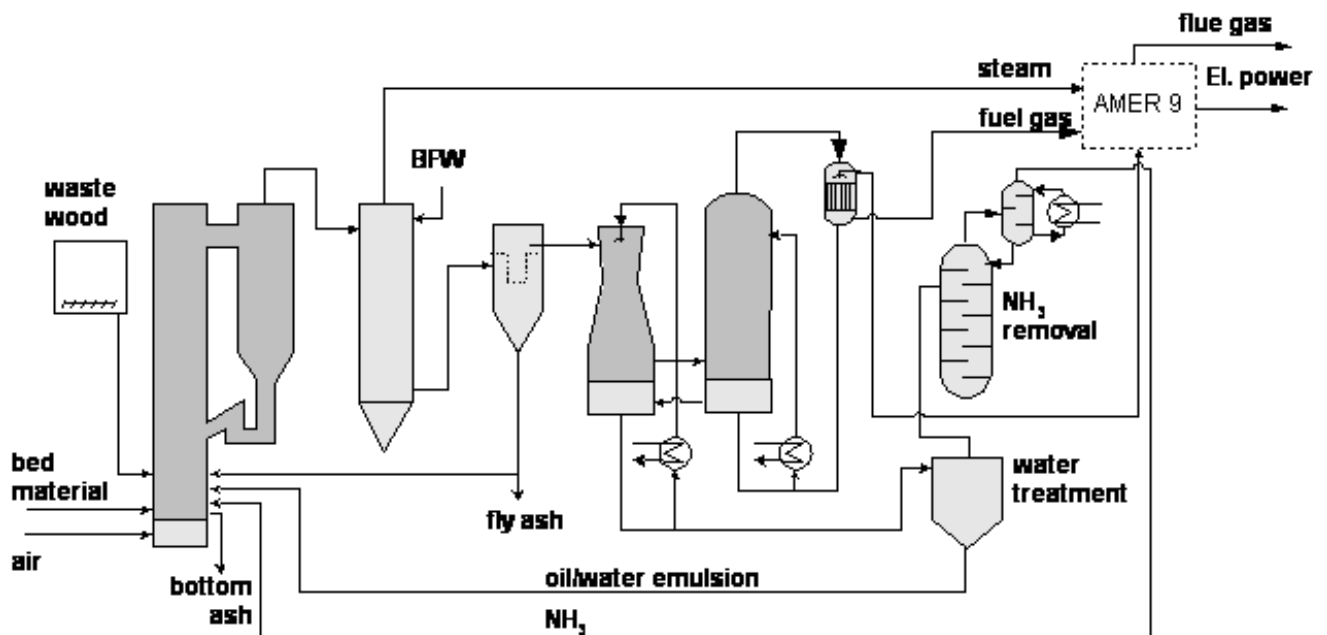

Figure 50 The Amergas original flowsheet<sup>266</sup>.

Finally, in 2002 it was decided to drastically change the process configuration, see Figure 51.

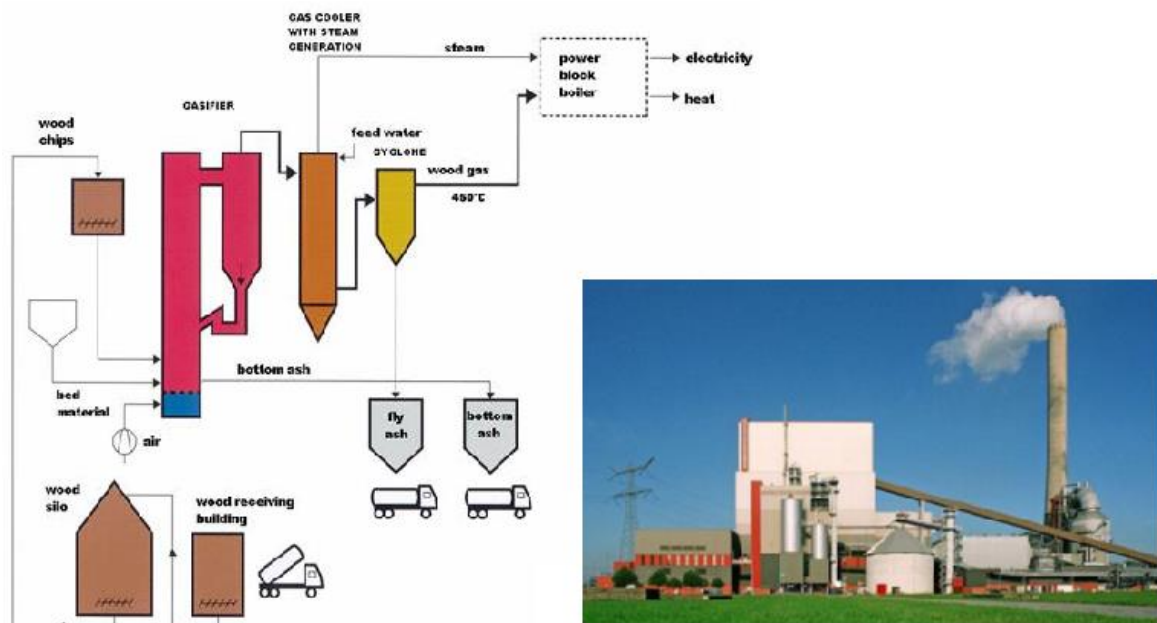

Figure 51 The modified Amergas flowsheet and a photo of AMER 9 boiler with the gasifier in front<sup>272</sup>

In this new design the gas cooler was modified such that the gas is only cooled to 450 °C, and the pipes were replaced by panels which were fitted with knockers. Also, the baghouse filters and the scrubbers were replaced two parallel cyclones and the partially dedusted gas is directed to the main

<sup>272</sup> Essent's wood gasifier project and process re-design. Wim Willerboer. Essent Biomass Conference 2009, Geertruidenberg November 4 -5, 2009

coal boiler at 400-450 °C. These modifications improved some of the problems encountered e.g. fouling somewhat but the start-up issues and agglomeration tendencies remained such that the situation overall remained unsatisfactory.

At this point the supplier Lurgi left the project and Essent continued with an improvement program up to 2005. To avoid some of the fuel quality and feeding problems a metal trap to remove larger pieces of metal that caused feeding and ash removal issues was installed but did not really solve the problems (metals such as nails, screws, hinges and slide bars, etc. were fastened to pieces of demolition wood). The tendency for bed agglomeration was addressed in several ways: by the metal separator to avoid aluminium-induced large agglomerates, during start-up by replacing the start-up burners inside the gasifier vessel to start-up burners exterior to the gasifier to avoid flame hot spot, by changing the bed material to a slightly coarser quality to reduce bed losses and thereby improve the gasifier operation, improve the bottom ash removal to avoid accumulation of coarse particles and agglomerates, and replacing air with steam as drive gas in the recycle loop seal. Furthermore, the double-cyclones had very high inlet velocities to achieve a high separation efficiency. The high velocity caused erosion, but the redesign was made to decrease this velocity while still maintain a high efficiency, while the use of coarser bed material meant that less fines came to these cyclones.

The start-up fire issues were addressed by changing the entire operational sequence so that at no point in time, the oxygen content should exceed 1 %, and add a laser-based measurement system for monitoring of oxygen. This required that the start-up burners were operated at sub-stoichiometric combustion conditions, that the fluidizing air was replaced by steam during the start-up, and that the combustion of wood in the bed as a means to heat the plant once the ignition temperature was reached, had to be abolished. Instead, external start-up burners are used to provide heat to the gasifier until the gasification temperature is reached, using steam flow for temperature moderation.

Also, the automation and safety system were modified, since they had originally been designed with too high complexity and with different automation programmes, which in itself caused nuisance trips. This program was carried out to 2005 eliminated the risk for fly ash fires and reduced the problems with agglomeration and the number of control system nuisance trips, Figure 52.

However, the metal removal and hence the availability of the feed system was not improved to the same extent. In addition, the issues with ash and tar fouling of the gas cooler largely remained even if the off-line cleaning interval could be raised from 2 to 4 months from the combined effect of reducing the number of trips, and a small decrease of the gasifier temperature.

In 2006, and as the WID was implemented in the Netherlands, the plant had to stop operation for some time, as by the strict interpretation of the WID by Dutch authorities, the entire Amer 9 complex would become a waste co-incinerator. This interpretation was later in the same year rejected by EU authorities, as the condensation of most heavy metals in the gas and removal as part of the fly ash in the cyclones made the gas less contaminated than if the fuel had been used directly, and operation was resumed.

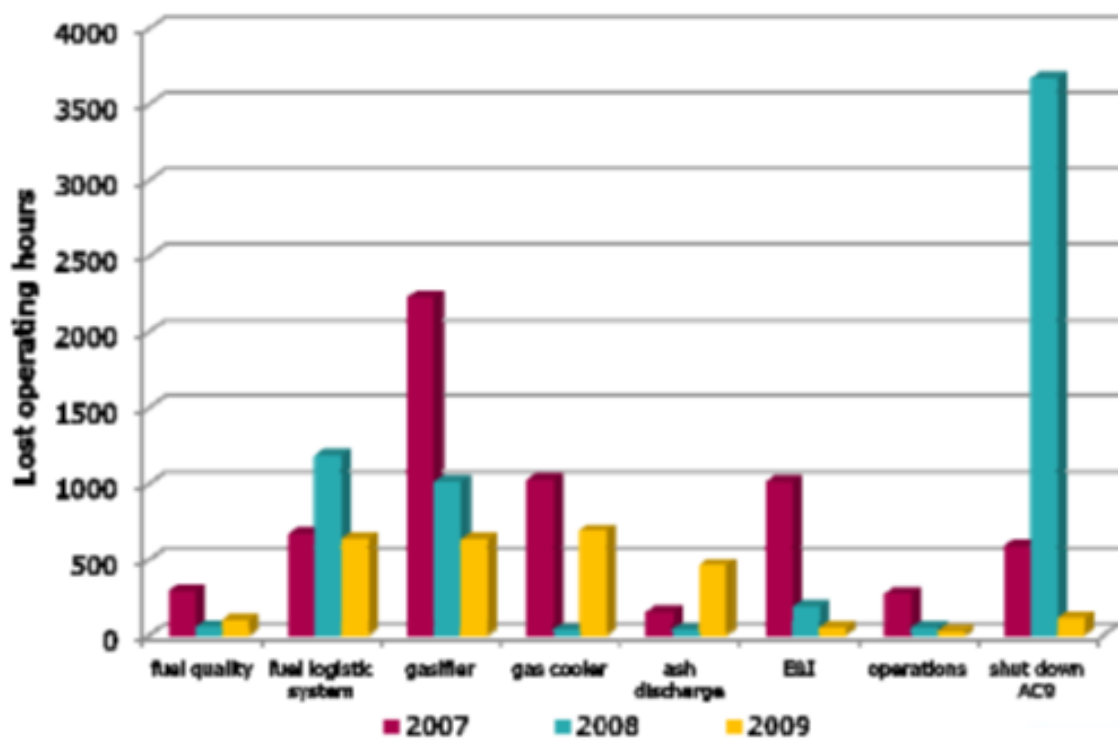

Figure 52 Grouped trip loss of operating hours<sup>271</sup>



Figure 53 Amergas gas cooler<sup>271</sup>.



Since 2006, the gasification plant was operated up to 2013, when the MEP support period ended, and the plant was shut-down. From 2006, the plant has typically operated 5 000 hours per year. The main limitations are feed system trips and the need for off-line cleaning of the gas cooler within regular intervals, as visualised by Figure 53. A typical gas composition is shown in Table 23.

During the later operational part, there were plans to gasify RDF instead of the demolition wood, as the gate fee would compensate for the loss of MEP support and allow the plant to continue operation. Test were made in early 2014 with up to 40 % RDF in the fuel<sup>268</sup>.

**Table 23 Typical gas composition from the Amergas gasifier<sup>273</sup>**

Component	Vol% dry basis
H <sub>2</sub>	11.1
CO	13.4
CO <sub>2</sub>	14.9
CH <sub>4</sub>	4.4
C <sub>2</sub> H <sub>6</sub>	0.27
C <sub>2</sub> H <sub>2</sub> +C <sub>2</sub> H <sub>4</sub>	Slight increase in some elements, base level low
C <sub>6</sub> H <sub>6</sub>	No change
H <sub>2</sub> S	1.2
N <sub>2</sub>	51.4
O <sub>2</sub> +Ar	0.6
<hr/>	
H <sub>2</sub> O	26 vol.%, wet basis
Dust	10.5 g/Nm <sup>3</sup>
LHV	5.55 MJ/Nm <sup>3</sup>

In general, these tests were successful in demonstrating that such a mixture could be fed and gasified. However, RDF also means an increased fly-ash load and also additional fouling problems, such that it was found that the gasifier temperature had to be reduced to 750 °C in order to avoid very rapid fouling, even if there was still more excessive fouling than with demolition wood alone. Fouling was mainly located at the higher inlet section of the gas cooler and it was concluded that the cooling panel spacing needed to be increased.

Essent applied for SDE+ (Stimuleren van Duurzame Energie, stimulation for sustainable energy) program support in 2014 but the application was not successful<sup>274</sup>. A new application in 2016 was more successful and three SDE+ subsidies were granted in 2016 for a total of 1.7 billion € for 8 years. It was reported that Essent/RWE is currently evaluating options to develop the site<sup>275</sup>.

### 7.2.2. Lahti I (Kymijärvi I), Finland

Lahti is a town in Finland with high ambitions regarding environmental and climate performance, whereby it had an interest in both replacing coal by indigenous fuels in its CHP plant to reduce emissions and also to reduce the disposal of waste in landfill.

<sup>273</sup> Gasifier modifications and Commissioning. Martin Spanjers. Essent Biomass Conference 2009, Geertruidenberg November 4 -5, 2009.

<sup>274</sup> The Netherlands country report. Berend Vreugdenhil. IEA Bioenergy Task 33 meeting. Berlin, Germany. 29th of October 2015

<sup>275</sup> The Netherlands country report. B.J. Vreugdenhil, G. Aranda Almansa. IEA Bioenergy Task 33 meeting. Innsbruck, Austria. 2<sup>nd</sup> May 2017

The Kymijärvi I 167 MW<sub>e</sub>/250 MW<sub>th</sub> co-generation plant is owned by Lathi Energia Oy (*fka* Lahden Lämpövoima). The plant was installed in 1976 and was originally oil-fired boiler but was modified for coal-firing in 1982. The coal burners use flue gas circulation and a staged combustion approach is used to reduce NO<sub>x</sub>-emissions. The boiler is of a Benson type with live steam conditions of 540 °C and 17 MPa with reheat at 540 °C and 4 MPa. In 1986, the plant also had a 49 MW<sub>e</sub> gas turbine connected to the heat exchanger used to pre-heat the boiler feedwater, which is used mainly for peaking operation in the wintertime. When in use the maximum electric output in condensing mode is 200 MW<sub>e</sub><sup>276 277 278</sup>. When the plant operates with full load on the heat, the output is 175 MW<sub>e</sub>, of which 130 MW<sub>e</sub> is form the steam turbine. The plant is operated in parallel to the Kymijärvi II plant, see section 7.3.2.4. The plant is due to be phased out in 2019, when a new biomass CFB heat-only boiler of 158 MW<sub>th</sub> will be taken into operation<sup>279</sup>.

In 1998, indirect co-firing of biomass into the main boiler was initiated after that SHI FW (*fka* Ahlström Pyropower and Foster Wheeler Finland) had installed a CFB gasifier, Figure 54.

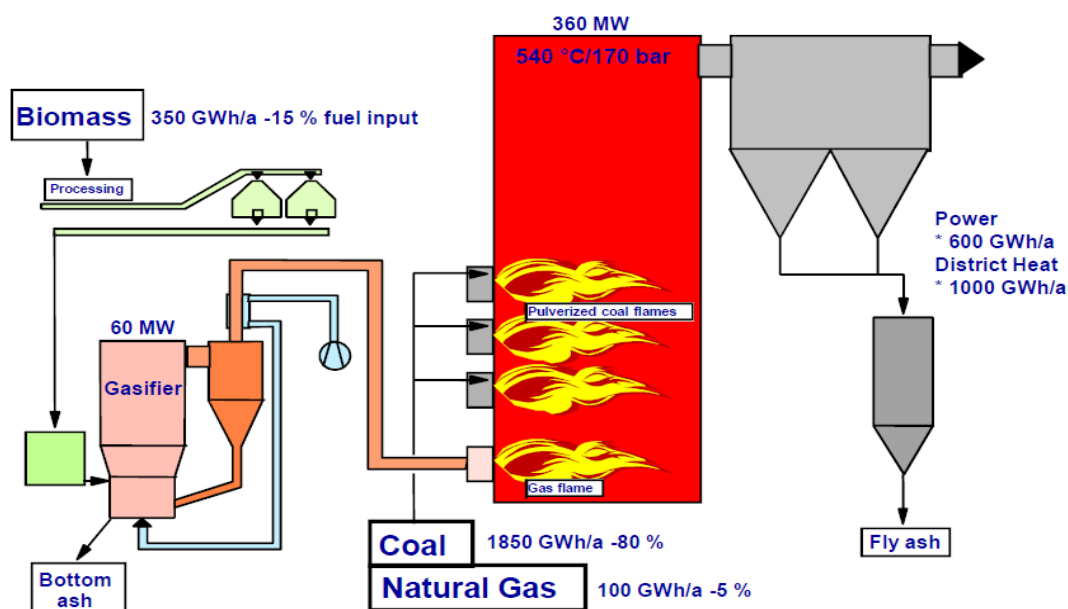

**Figure 54 Lahti Energy Oy Kymijärvi I plant**<sup>280</sup>

The background to the installation was that Lahti Energia wanted to reduce emissions from the coal boiler by partially replacing the coal with a fuel with less sulphur and also reduce NO<sub>x</sub>, as well as reduce the emissions of CO<sub>2</sub> from fossil fuels. A second motive was to reduce the disposal of waste in landfills after the introduction of a source separation and collection system in the area. However, the use of waste in the gasifier and then co-firing the gas led to a lengthy procedure for the environmental permitting, made further complicated when the WID came into force, see Section 4.3.1.

The full load energy input to the gasifier is 40MW<sub>th</sub> to 70MW<sub>th</sub>, the span being related to the

<sup>276</sup> <https://bio-chp.force.dk/downloads/chp-plants-key-figures/lahti-energia-oy-kymijarvi-power-plant-finland/>

<sup>277</sup> [www.power-technology.com/projects/kymijarvi/](http://www.power-technology.com/projects/kymijarvi/)

<sup>278</sup> Case Study on Lahden Lämpövoima Gasification Project Kymijarvi Power Station, Lahti, Finland. D.L. Granatstein. IEA Bioenergy Agreement—Task 36. November 2002

<sup>279</sup> Communication with H. Takala, Lahti Energia Oy.

<sup>280</sup> Thermal gasification for Power and Fuels – VTT Gasification Team. Esa Kurkela. VTT 2010

moisture content of the as-fed fuels, which can vary between 20 wt.% to 50 wt.%. The total installed cost of the gasification plant was about 12 M€, including fuel preparation, civil works, the gasifier, instrumentation and control, electrification as well as modifications to the main boiler, and of which 25 % was received as a grant from the EU THERMIE program. However, the supplier may have seen this project as a valuable reference and charged less than the commercial value<sup>278</sup>. The cost split between the fuel handling and the gasifier sections was 4 and 8 million Euro, respectively<sup>276</sup>.

Fuels are transported to the plant by trucks to the plant feed reception station, Figure 55, which is managed by the fuel company and can accept trucks up to 16 hours per day<sup>281</sup>. There are two receiving halls, for waste type fuels and for biomass fuels, respectively. The typical moisture content of the fuels is 45-55 % for the saw dust and wood residues, 10-20 % for the dry wood residues from refining and 10-30 % for the RDF waste. The high moisture content means that some winterization of the storage and feed system was required. The energy density of fuels varies in the range of 2.9 – 4.5 GJ/m<sup>3</sup> (0.8 - 1.25 MWh/m<sup>3</sup>).

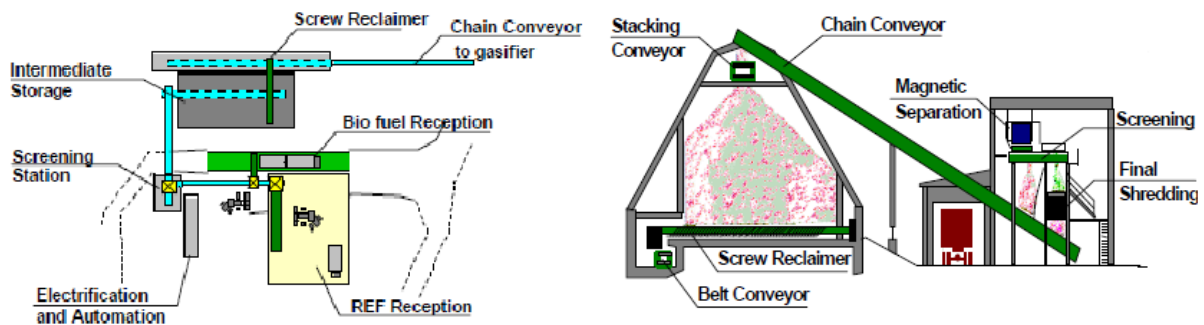

**Figure 55 The Lahti I waste handling system<sup>281</sup>**

The waste fuel hall is equipped with a receiving pit having a lamella feeder to control the flow of fuel to a slow-rotating crusher (Figure 55). Coarse bio fuel from the wood refining industry is also fed through this system. The trucks dump the fuel into a receiving pit or on the floor of the hall. There is an underground conveyor that transports the fuels from the crusher.

The other receiving bunker is for the fine material, like saw dust and milled peat that arrives to the plant by trucks equipped with chain unloading system. The truck drives "through" the receiving tunnel. The discharging takes place on a flat chain conveyor, which drops the fuels on the screen. The accepted fraction falls onto the chain conveyor at the bottom of bunker while material retained on the screen is routed to the waste hall for pre-crushing.

The underground conveyors lift the fuels to a belt conveyor which has a magnetic separator. The belt feeds a disk screen. The overflow falls into the final crusher, while the accepted fuel fraction and crushed material is transported into the intermediate storage by a chain conveyor. The 3 000 m<sup>3</sup> fuel storage silo is rectangular with a concrete floor and has walls and roof made of steel. The fuels are distributed along the length of the storage by stacking chain conveyor to provide some mixing and homogenization before the feeding it to the gasifier. The storage is unloaded by a screw reclaimer onto a chain conveyor that brings the fuel up into the gasifier structure where it is fed into two 10 m<sup>3</sup> feeding silos on either side of gasifier. Each silo is equipped with adjustable speed screw dischargers which dose the fuel falling through double rotary feeders for sealing into a feed screw

<sup>281</sup> THE ANALYSIS REPORT OF PLANT NO. 19. Cofiring of biomass - evaluation of fuel procurement and handling in selected existing plants and exchange of information (COFIRING) - Part 2. Kymijärvi - Lahden Lämpövoima Oy, Finland. Timo Järvinen. EUBIONET II 2001. (<http://eubionet2.ohoi.net>)

leading into the gasifier. Bed material and limestone can be added into the fuel flow. The entire fuel system is fitted with appropriate fire detection and extinguishing equipment.

The gasifier, Figure 56, consists of a cylindrical refractory-lined steel vessel, where the fuel is gasified in a hot gas-solid particle suspension at atmospheric pressure at the temperature of about 850 °C. The hot gas flowing through the uniflow cyclone is cooled down in an air preheater before feeding to the main boiler. Bed material make-up, like sand and limestone, approximately amount to 200–300 kg/h.

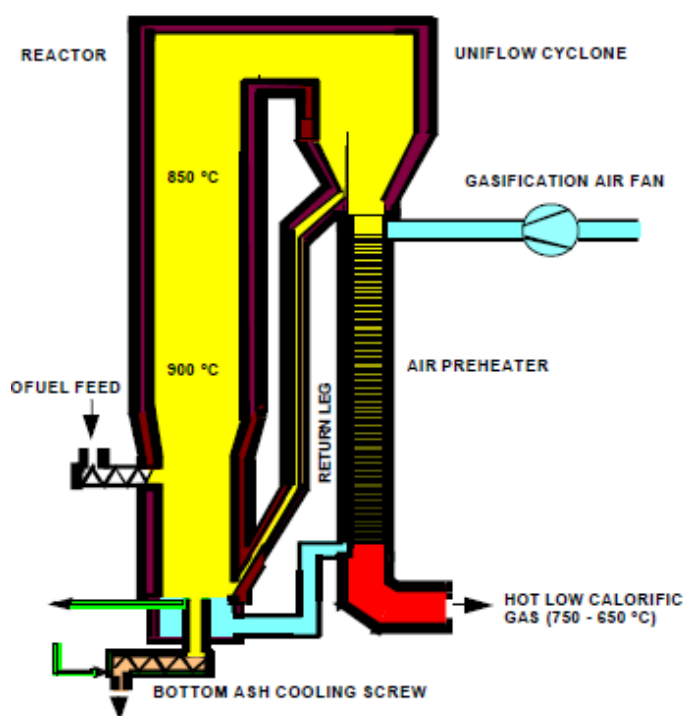

**Figure 56 The Foster Wheeler gasifier used at the Lahti plant** <sup>282</sup>

The major differences to the design of lime kiln gasifiers supplied in the 1980s is that the fuel is not dried and has a variable moisture content and that mainly the waste will contain metal pieces, which is reflected in the design of the air grid and the bottom ash extraction.

The hot gas is directly routed to two burners located below the coal burners in the main boiler. When the fuel is wet, the heating value of the gas is very low. Typically, when the fuel moisture is about 50 % the calorific value is only approximately 2.2 MJ/kg, but with a high amount of plastics and a dry fuel it can go as high as 4.5 MJ/Nm<sup>3</sup>. The typical gas composition is shown in Table 24.

The design of the product gas burners is unique and heavily based on both the pilot scale combustion tests and CFD modelling work.

The effects of gasification on the main boiler were studied with comprehensive measurements during a one-year monitoring program in 1998. The product gas combustion has been stable even though the moisture content of solid fuel has been mostly high and the heating value of the gas very low. Furthermore, the stability of the main boiler steam cycle has been excellent. The large

<sup>282</sup> Foster Wheeler biomass gasifier experiences from Lahti & Ruien and further cases for difficult biomass & RDF gasification. Timo Anttikoski, Juha Palonen, Timo Eriksson. IEA Bioenergy ExCo 55, Copenhagen, Denmark, 25 May 2005.

opening that were made for the LCV gas burners have not caused any disturbance in the water/steam circulation system stability or for the main boiler coal burners, despite placing LCV gas burners very close to the lowest level coal burners.

**Table 24 Gas composition of product gas from Lahti plant<sup>278, 280, 282, 281</sup>**

Average bulk gas composition		Minor components in the gas	
Component	Vol %	Component	Concentration
CO	10	NH <sub>3</sub>	800-1 000 mg/Nm <sup>3</sup>
CO <sub>2</sub>	12	HCN	25-45 mg/Nm <sup>3</sup>
CH <sub>4</sub>	3	HCl	30-90 ppmv
H <sub>2</sub>	7	H <sub>2</sub> S	50-80 ppmv
H <sub>2</sub> O	35	Benzene	7-12 g/Nm <sup>3</sup>
N <sub>2</sub>	Ballance	Tar	7-12 g/Nm <sup>3</sup>
		Alkalis	< 0.1 ppmw
LHV MJ/Nm <sup>3</sup>	2.5-4.5	Particulates	6-12 g/Nm <sup>3</sup>

Despite using fuels with alkalis and chlorine, the plant does not apparently suffer from unusual amounts of fuel deposits or high-temperature corrosion. The availability has in general been 96-99 %, and the overall availability of the boiler has not been affected by the use of the gasifier and its fuel<sup>283</sup>.

The use of LCV gas in the boiler had only a small impact on the emissions, as seen in Table 25. The changes in the boiler emissions were such that NO<sub>x</sub> decreased by 10 mg/MJ or 10-20 % relative to the base level; SO<sub>x</sub> decreased by 20 - 25 mg/MJ from substitution of coal for a fuel lower in sulphur, while HCl increased by 5 mg/MJ due to that the RDF has higher chlorine content than the coal, and also particulates were reduced by 15 mg/Nm<sup>3</sup>. For CO and organics there were no changes while for heavy metals there were both increase and decreases relating to the individual metals. The gasifier bottom ash is disposed of in a local landfill.

**Table 25 Emission impact of the indirect co-firing<sup>278, 280, 282, 281</sup>**

Emission	Change caused by gasifier co-firing mg/MJ fuel input or mg/Nm <sup>3</sup>
NO <sub>x</sub>	Decrease by 10 mg/MJ (5 - 10 % of the base level)
SO <sub>x</sub>	Decrease by 20 - 25 mg/MJ
HCl	Increase by 5 mg/MJ
CO	No change
Particulates	Decrease by 15 mg/Nm <sup>3</sup>
Heavy metals	Slight increase in some elements, base level low
Dioxins, Furans, PAH, Benzenes and Phenols	No change

The O&M cost were estimated to 0.5 million € in 2001 (i.e. just over 0.4 % of the investment/year) broken down into the main expenses, maintenance of the fuel handling 0.2 million, cost of bed

<sup>283</sup> History of Gasification Technology in Lathi-How We Have Come to This Point. Matti Kivelä. Advanced WtE Technologies Seminar. May 8-9, 2012. Lathi, Finland.

material 0.1 million, gasifier maintenance 0.03 million, and fuel quality control 0.03 million<sup>281</sup>. The entire plant was then served by four persons per shift.

The fuel mixture used up to 2010 is shown in Figure 57. Until April 2012, the approximate fuel blend was 20 % wood, 40 % SRF and 40 % recycled wood/demolition wood.

In autumn of 2012, when Kymijärvi II plant started, the plant has been regularly in operation about 5000 hours/year using biomass and recycled wood<sup>279</sup>.

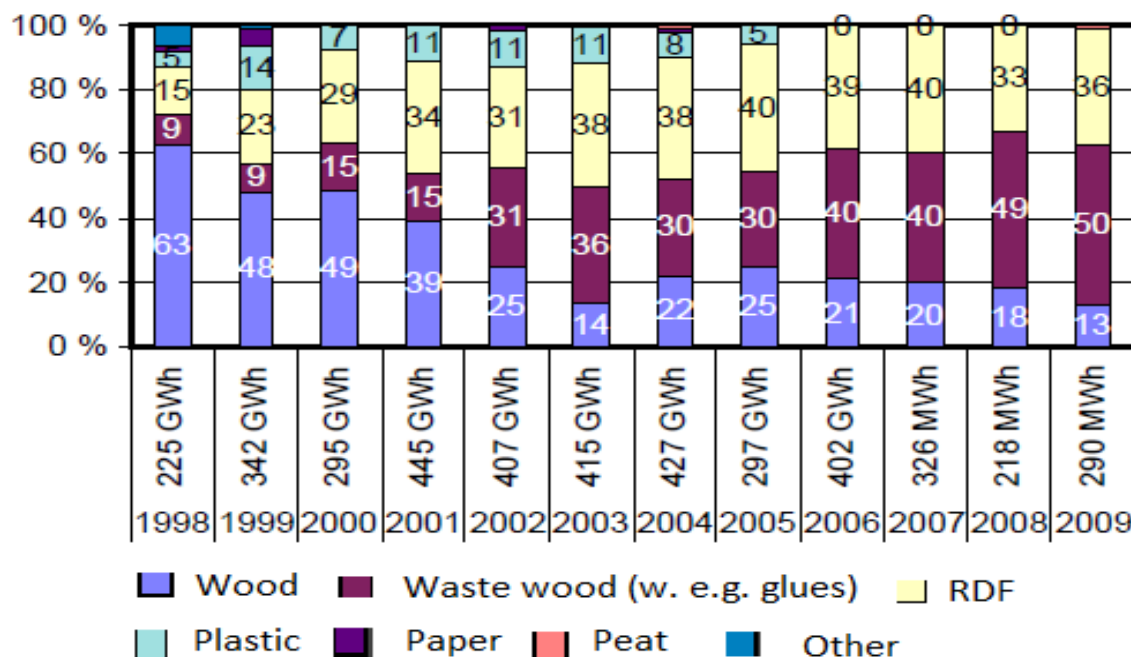

**Figure 57 Relative usage of different types of fuels in Kymijärvi I 1998-2010<sup>284</sup>**

As was noted in the introduction, the entire plant will be decommissioned in 2019 when Kymijärvi III, a biomass-fired CFB heat-only boiler<sup>285</sup>, is being taking into operation.

### 7.3. COMBINED POWER AND HEAT

The generation of combined power and heat (CHP) by gasification is typically accomplished in systems with a close-coupled combustion of the gas without any or minimal preceding gas cleaning, two-stage incinerators, and so called "true" gasification systems, where the gas is subjected to a more or less rigorous gas cleaning, going beyond removal of the coarser particulates by cyclones. The gas can then be subjected to one or more cleaning operations such that in the EU, finally the WFD end-of-waste criterion is met. If the ultimate aim is to burn the gas to generate heat and power, also gasifiers are as mentioned previously covered by the waste incinerator part of the IED.

In the past, it was seen that gasifiers using e.g. fluidized beds would require pre-treated waste whereas incinerators could use waste directly as a generated. However, over time, also incinerators require more pre-treated waste fuel to have better performance and availability while also from a policy perspective, there are strong drivers to achieve source separation or mechanical separation to increase the recycling of wastes prior to combustion ranging from formal bans to softer

<sup>284</sup> Kokemuksia termisestä kaasutuksesta. Matti Kivelä Lahti Energia. 22.04.2010

<sup>285</sup> <https://bioenergyinternational.com/heat-power/amec-foster-wheeler-supply-biomass-cfb-boiler-lahti-energia-kymijarvi-iii>

recommendations.

In the context of this report, the focus is true gasification systems in relation to two-stage incinerator systems. The reason for this is the fact that overall, the performance of such systems in terms of the energy efficiency to power is at best similar, but mostly inferior to conventional state-of-the-art incineration<sup>286, 287</sup> and in many cases the basic technologies (conversion reactor type, heat recovery system flue gas cleaning) are also more or less similar to such incinerators. Furthermore, these have been in commercial use for quite some time and therefore there is already a lot of information on technologies, performance and experiences publicly available.

Instead the focus is to be more forward-looking and describe the potential of waste gasification systems with some more elaborated gas clean-up. The use of waste treatment by means of gasification and gas cleaning gives an added value in terms of performance compared to one- or two-stage incinerators for both an enhanced energy recovery by steam cycles or other prime movers, or for material recovery by utilizing the clean gas for chemical conversion to fuels and chemicals.

### 7.3.1. Two-stage incinerators

As noted above, the so-called two stage incinerators are dealt with only briefly in this report as the performance is close to conventional incinerators, that such systems have been in commercial use for quite some time and therefore there are already detailed overview publications available.<sup>286, 287, 288 289, 290, 291 292, 293</sup>. In particular, a report by the consultancy WSP<sup>294</sup> and a recent German report<sup>295</sup> covers many of these technologies in some detail.

Most so-called waste gasification installations do not process the gas by any gas cleaning other than maybe cyclone separation in between the generation of the gas in the gasifier and the final combustion (oxidation) of the combustible components in the gas. In some cases, the gasification process itself or the final oxidation of the gas is associated with melting of the ash to vitrify it, and thereby render it less leachable. Following the combustion of the gas, heat recovery is achieved by steam generation, or more unusually by an ORC cycle, that drives a turbine to generate or co-generate power or power and heat, respectively.

Therefore, such a process can be seen as a two-stage incinerator (or as some "environmentalists" phrase it, "an incinerator in disguise"<sup>296, 297</sup>). This also means that the environmental performance and the energy efficiency to power at best is comparable to a conventional incinerator of the same capacity. However, due to the additional heat losses from the combined gasifier-combustion unit, and in particular from the energy consumed if ash melting is included, the efficiency to power is lower than for a comparable incinerator. Furthermore, the use of the same types of post-combustion

<sup>286</sup> Waste gasification vs. conventional Waste-to-Energy: a comparative evaluation of two commercial technologies. Consonni S, Viganò F. *Waste Management*. 2012 Apr;32(4):653-66.

<sup>287</sup> Advanced Thermal Treatment of Municipal Solid Waste. Department for Environment, Food & Rural Affairs (Defra), UK. February 2013

<sup>288</sup> Pyrolysis and gasification of waste. A worldwide technology and business review. Juniper (2001).

<sup>289</sup> Alternative Waste Conversion Technologies. ISWA (International Solid Waste Association), January 2013

<sup>290</sup> Process and technological aspects of municipal solid waste gasification. A review. Umberto Arena. *Waste Management* 32 (2012) 625–639.

<sup>291</sup> Advanced Thermal Treatment Technologies for Waste. – Present State of the Art. Frans Lamers, Robert van Kessel. *Waste Management*, Volume 2. Ed. Karl J. Thomé-Kozmiensky, Stephanie Thiel, TK Verlag Vivis. Published: 2011.

<sup>292</sup> Pyrolysis and Gasification – State of the Art. Peter Quicker. *Waste Management*, Volume 5. Ed. Karl J. Thomé-Kozmiensky, Stephanie Thiel, TK Verlag Vivis. Published: 2015

<sup>293</sup> Waste gasification vs. conventional Waste-to-Energy: a comparative evaluation of two commercial technologies, S. Consonni, F. Viganò. *Waste Management*, 32(4),201, p. 653-66

<sup>294</sup> Review of State-of-the-Art Waste-To-Energy Technologies. Stage Two – Case Studies. K. Whiting, WSP. January 2013

<sup>295</sup> Status of Alternative Techniques for Thermal Waste Treatment Expert Report. Final Report. P. Quicker, F. Neurburg, Y Noël, A. Huras, R. G. Eyssen, H. Seifert, J Veblow and K. Thomé-Kozmiensky. Expert report for the Federal Ministry for the Environment, Nature Conservation, Building and Nuclear Safety. Project No. Z 6 –30 345/18 Report No. 29217. June 2015

<sup>296</sup> <http://www.no-burn.org/incinerators-in-disguise-and-so-called-waste-to-energy/>

<sup>297</sup> <http://www.energyjustice.net/incineration>

flue gas cleaning as state-of-the-art incinerators use means that the same low emissions of regulated contaminants can be reached. Since the capacity of gasification systems in many cases is lower than for a typical incinerator, the scale of the installation can result in that the performance is somewhat inferior as losses are higher in small capacity units and optimized designs may use less sophisticated steam cycles are used. An overview of some of the most common technologies, kilns, shaft furnaces and grates, respectively, are described below. In Table 26, some suppliers/developers are listed. Please also refer to Section 5.2 for more descriptions of the various basic technologies.

**Table 26 Waste gasification system suppliers**

Developer/ supplier	Gasifier type	Oxidant	Gas cleaning	Gas use	Notes
<b>Kilns</b>					
Ansac	Indirect kiln	Air		CHP	
Citorn Holding	Kiln				
ConTherm	Indirect drum pyrolysis	Air	Total oxidation	CHP	Burgau plant closed in 2015
Greene	Indirect kiln	Air O <sub>2</sub>	Thermal	CHP	
ICM	Auger kiln Updraft	Air	Total oxidation (Fuel gas)		
IES	Auger kiln	Air	Total. oxidation (Fuel gas)	CHP	
IHI	Kiln	Air	Total oxidation		
Mitsui	Kiln		Total oxidation		<i>Fka</i> Siemens Schwellbrenn process, see Section 7.3.1.3
Mitsui	Kiln	Air	Total oxidation	CHP	
Premier green Energy	Indirect kiln	Air		CHP	
Takuma	Kiln		Total oxidation		<i>Fka</i> Siemens Schwellbrenn process, see Section 7.3.1.3
W2E	Kiln	Air		CHP	
<b>Tunnel</b>					
Hoskinson Group	Tunnel	Air	Total oxidation	CHP	
JFE	Tunnel, indirect/direct		Thermal		<i>Fka</i> Thermostelect, see Section 7.3.2.11
<b>Fixed beds</b>					
Biomass Power Ltd	Grate	Air	Total oxidation	CHP	
Covanta	Grate	Air			Cleergas
EER/Envitec	Updraft shaft plasma	Air	Total oxidation	CHP	
Energos	Grate	Air	Total oxidation	CHP	
Entrade	Downdraft?		?	CHP	Bought Agnion
Hitachi Metals	Updraft	Air	Total oxidation		
InEnTEC	Downdraft	Air or O <sub>2</sub>	Plasma,		
JFE	Updraft/ fluid bed	Air	Total oxidation		
Kawazaki	Shaft	Air/O <sub>2</sub>	Total oxidation		
Nexterra	Updraft	Air	Total oxidation	CHP	



Nippon steel	Updraft	Air	Total oxidation		
PHG Energy	Downdraft	Air	Total oxidation	CHP	MaxWest Environmental Systems
PRME	Updraft	Air			See CHO Power, Section 7.3.2.2

**Table 27 Gasification system suppliers, continued**

Developer / supplier	Gasifier type	Oxidant	Gas cleaning	Gas use	Notes
<b>Fluidized beds</b>					
AMEC Foster Wheeler	CFB	Air	Total oxidation	Fuel gas	See Sections 7.1.6 and 7.2.2
EBARA	Internal CFB	Air O <sub>2</sub>	Total oxidation Thermal	CHP Synthesis	See also EUP Kobe, Section 7.4.1.1
Envirotherm	CFB	Air	Various	Fuel gas, CHP	<i>fka</i> Lurgi CFB gasifier, see Section 7.1.1
Eqtec	Stationary	Air	Total oxidation Thermal	CHP	
Kawasaki	Stationary	Air	Total oxidation	Fuel gas	See section 7.1.2
Kobelco	Stationary	Air or O <sub>2</sub>	Total oxidation	CHP	Cooperation w. CHO Power see section 7.3.2.2
LLT	CFB	Air	Total oxidation thermal	Fuel gas	<i>Fka</i> TPS process, see also Section 7.1.4
Outotec	Stationary	Air or O <sub>2</sub>	Total oxidation	CHP Synthesis	Cooperation with APP, see Section 7.4.2.1
Mitsubishi	Stationary	Air	Total oxidation	CHP	
TKK	Stationary	O <sub>2</sub>	Thermal		HTW technology.
<b>Other</b>					
Chinook	Indirect batch	Air	Thermal	CHP	

### 7.3.1.1. An example of a grate gasification process; Energos<sup>298</sup>

The Energos technology was developed in Norway during the 1990s to address the market for small scale energy from waste plants in Norway and elsewhere, while the technology was still flexible in terms of the waste feed characteristics, was cost-efficient and met high emission standards.

This resulted in a two-stage combustion approach with a primary grate gasification furnace with the oxidation chamber directly above the primary chamber, which was later changed to a concept with a separate downstream oxidation or secondary chamber, see the upper part of Figure 58. Following the oxidation chamber there is a heat recovery section followed by the flue gas cleaning, see the lower part of Figure 58.

The waste needs to be pre-treated by shredding and by magnetic separation of ferrous materials,

<sup>298</sup> <http://www.energus.com>

either integrated on site or at an off-site location prior to shipping the waste to the plant<sup>300, 299</sup>. After pre-treatment, the waste is stored in a bunker from which an automatic crane drops it into a fuel hopper. From the fuel hopper the waste is fed into the gasification feeding chamber by means of a stoker via a guillotine valve to maintain a consistent fuel layer on the horizontal, fixed grate. The grate is oil-cooled and is separated into different sections, each with an individual air supply. Bottom ash is discharged from the primary chamber at the end of the grate and holds less than 3 % combustible components.

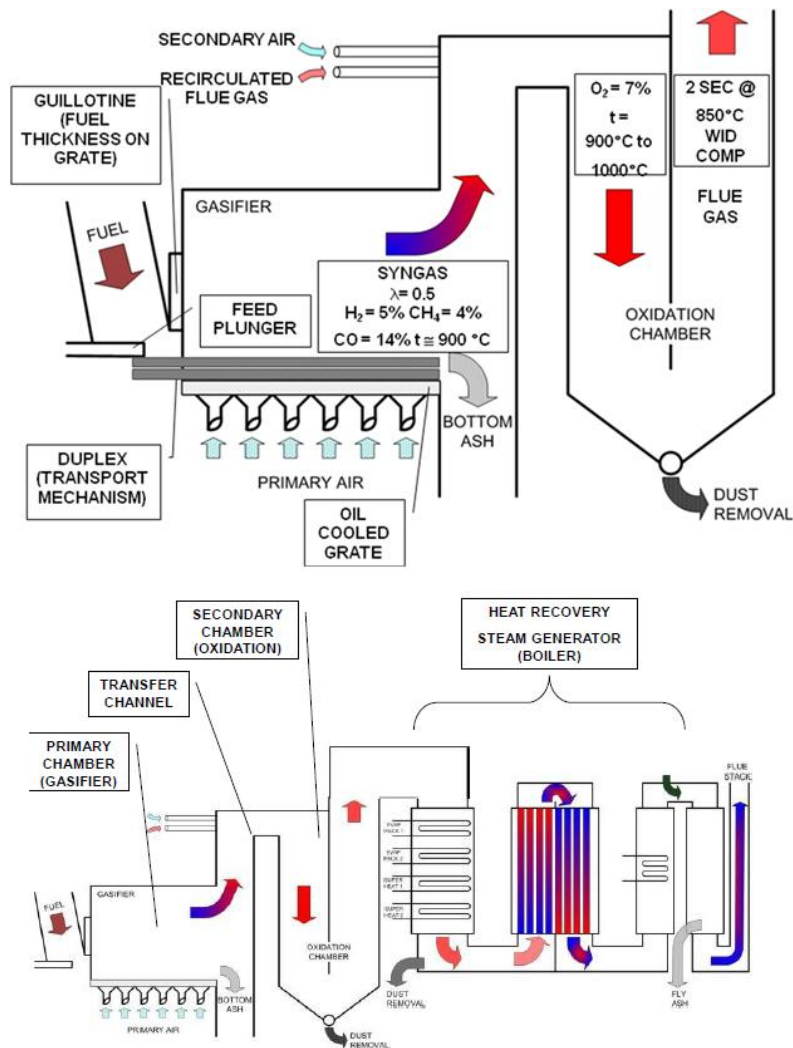

**Figure 58 The Energos process<sup>300</sup>**

The gasifier chamber is fed with air at a total of 50-80 % of stoichiometric air at approximately 900 °C. The gases produced are mixed with secondary air and recirculated flue gas in a controlled way at the inlet of the oxidation chamber in such a way that the combustion is homogenous at around 1000 °C, and therefore reduces CO and hydrocarbon emissions and also limits NO<sub>x</sub> formation.

Hot flue gas from the secondary chamber is recovered in the heat recovery steam generator

<sup>299</sup> Small Scale Waste-to-Energy Technologies. Claudine Ellyin. MS Thesis. Department of Earth and Environmental Engineering, Columbia University, USA. September 2012

<sup>300</sup> ENERGOS Gasification Technology. Energy Recovery from Residual MSW and Commercial Waste. All-Energy 2014 Conference, May 21-22, 2014, Glasgow, UK.

consisting of a water-tube boiler, a fire-tube boiler and an economiser. A shot-ball system for is available for cleaning the heat transfer surfaces during operation.

Downstream the economiser, there is a simple dry flue-gas cleaning system using injection of lime and activated carbon. Fly ash and spent lime and activated carbon are separated from the flue-gas in a baghouse filter. The two-stage concept in combination with the controlled combustion can be successful in reducing NO<sub>x</sub> emission to such a low level that any additional clean-up is necessary. However, additional conventional control measures can be installed if so required.

The gasification chamber, high temperature oxidation chamber, water-tube boiler, smoke- tube boiler and the control system are patented proprietary designs. Other elements of the plant are standard components purchased from third- party suppliers.

In total 11 plants have been built since 1997 or are in construction /commissioning at present. Of these plants, three early plants in Norway have already been closed, while one plant in the UK is or will be closed shortly, and three plants, also in the UK are in construction or commissioning phases. These plants have been applied for power generation CHP and for generation of process steam only.

Energos has offered two standard gasifier modules of nominally 5 and 6 tonnes/hr, respectively, and heat recovery steam generators with a thermal capacity of 13.5 MW and 16.4 MW, respectively. This allows four combinations of gasifiers and heat recovery modules, thus a certain adaption for e.g. fuel quality parameters such as energy content. For larger waste capacities, several lines can be operated in parallel. The company has a history of pursuing both an own-operate and EPC strategy.

The Norwegian company Energos ASA was taken over by the UK company ENER-G in 2004 after suffering from economic difficulties. In 2016, the company went into administration due to cash flow issues<sup>301</sup>. Some additional operation data is available in previously cited reports<sup>294, 295</sup>.

#### **7.3.1.2. An example of a fixed bed; Nippon Steel Direct Melting Process**

The Nippon Steel Direct Melting Process (DMS) is one of the most widely used waste gasification processes mainly in Japan with over 40 installations in operation or construction since 1979<sup>302</sup>.

The gasification principle is an updraft moving bed or a shaft furnace<sup>303</sup>. A full plant is composed of the waste charging system, the gasifier, the combustion chamber, the boiler and a flue gas cleaning system as well as the power generation section, see Figure 59.

---

<sup>301</sup> <https://www.letsrecycle.com/news/latest-news/energ-os-enters-administration-over-cash-flow/>

<sup>302</sup> Direct Melting System Brochure. [https://www.eng.nssmc.com/english/whatwedo/wastetoenergy/wtoeplant/direct\\_melting\\_system/](https://www.eng.nssmc.com/english/whatwedo/wastetoenergy/wtoeplant/direct_melting_system/)

<sup>303</sup> Waste Gasification and Melting Technology. - Direct Melting System. Nobuhiro Tanigaki Waste to Energy 22th November 2017, AVG, Cologne, Germany

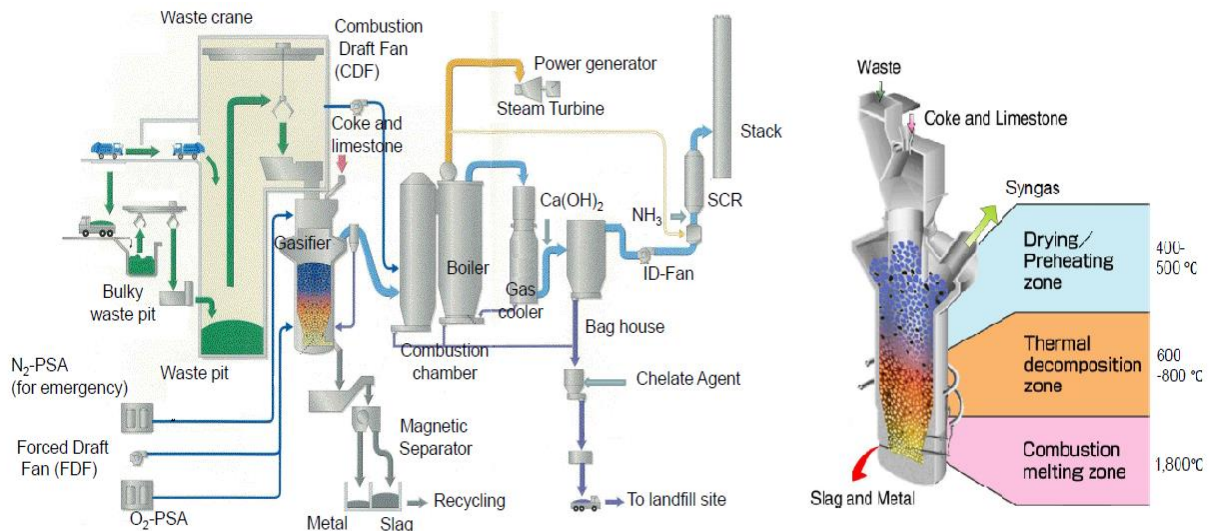

**Figure 59 The Nippon Steel & Sumikin Engineering shaft furnace process (adapted from<sup>303</sup>).**

The process has operated with a wide variety of wastes such as MSW and RDF, but also construction wastes, industrial wastes, sewage sludge, incombustible and combustible residues, clinical waste, asbestos, automobile shredder residues (ASR), and landfill excavation waste can be processed. It is claimed that the process does not need any pre-treatment of the waste and that it can accept waste up to a dimension of 800 mm and also fuels with quite low energy content as a result of inerts and moisture in the waste. The waste material, typically MSW, is fed at the gasifier top via a double-valve sluice system together with coke at a rate of 5-10 % of the waste weight. Also, limestone is added. These additives provide mechanical stability in the bed and the coke is also a reducing agent while the limestone is a fluxing agent.

The shaft furnace, a refractory lined cylinder, has three distinct zones, for drying and preheating at the top, for thermal decomposition in the middle part and for combustion and melting in the bottom part. In the bottom part, oxygen-enriched air, at approximately 35 % oxygen content, is fed into the shaft via tuyeres to reach a high enough temperature, approximately 1800 °C, to achieve a good burnout but also melting of the ash. The melt is discharged intermittently via a water-granulation system and a magnetic metals/inert slag separation. The inert slag can be used as building material and the metals recycled.

The hot gases generated at the bottom go up in the shaft into the decomposition zone and the drying preheating zone at 600- 800 °C and 500-400 °C, respectively before leaving the gasifier at the top. The gas has a heating value of 4- 6 MJ/Nm<sup>3</sup> and is directly routed to a combustion chamber, and then goes to the stack via a heat recovery steam generator and the flue gas cleaning section before being exhausted in the stack. The steam generated is used to generate electrical power in a steam turbine. Additional data are available in previously cited reports<sup>294, 295</sup>.

### **7.3.1.3. An example of a kiln process; Mitsui R21**

The Mitsui R21 process has been taken as an example of a kiln process. The Mitsui R21 process<sup>304</sup> has its origins in the Siemens Schwel-Brenn-process which was licensed in from 1991 and then further developed by Mitsui, Figure 60. The company built and operated two 1 ton/hr demonstration plants in Japan from 1994 to 2000. The first commercial installation, Yame Seibu Clean Center, came in 2000 with two lines of 110 tonnes/day each. Another eight identified plants have been built

<sup>304</sup> Mitsui Recycling 21 Pyrolysis Gasification & Melting Process. Mitsui Engineering & Shipbuilding Co., Ltd. Aug. 2004

since with capacities of 2 to 8 tonnes/hr per line, the two most recent of which began operation in 2009. However, ISWA states that up to 25 installations have been installed world-wide<sup>305</sup> but that the process is no longer marketed. Also, Takuma licensed the Siemens process and have built a handful of plants using this concept. The process is well-explained in Figure 60 which shows the 2 x 8 tonnes/hr Toyohashi plant.

The waste, shredded to below 200 mm, is fed to the pyrolysis kiln which can be over 20 m long and in this plant with a diameter of 3 m and where the feed is pyrolyzed at 450 °C for 1-2 hours. The drum is heated indirectly by means of an internal pipe system where hot air at 520 °C coming from a preheater in the boiler is circulated. The air is heated in the first boiler pass after the burning chamber.

Solid residue from the pyrolyser passes a magnetic and a fluidized bed separator for metal recovery. The coke is transferred to the combustion chamber in parallel to the pyrolysis gas. Combustion takes place at 1350 °C, this temperature being selected to ensure slagging of the inorganic material in the coke and the gas. The hot flue gas exits via a heat recovery steam generator, followed by conventional flue gas cleaning. Additional data can be found in the cited references<sup>294, 295</sup>.

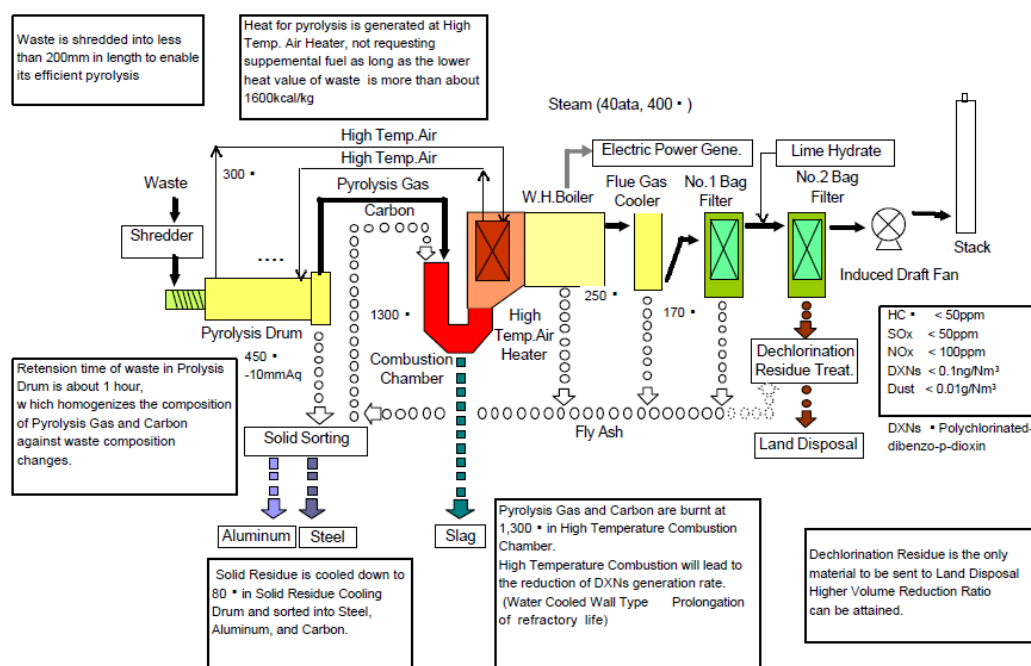

**Figure 60** The Mitsui R21 process<sup>306</sup>

### 7.3.1.4. An example of a fluidized bed gasification process, Outotec<sup>307</sup>.

The fluidized bed combustion and gasification systems of the Finnish company Outotec, formed from the technology part of the Finish steel and metallurgical company Outokumpu, trace its roots to the 1970s and the US company Energy Products of Idaho, one of the pioneers in the utilization of the fluidized bed technology. This company was acquired by Outotec in 2011 and had at that point some 100 fluidized bed references (mainly boilers but also gasifiers)<sup>308</sup>. The company markets two

<sup>305</sup> ISWA White Paper on Alternative Waste Conversion Technologies. F. Lamers, E. Fleck, L. Pelloni, B. Kamuk ISWA 2013

<sup>306</sup> Mitsui Recycling 21 Pyrolysis Gasification & Melting Process. Hiroaki Harada. Workshop on Operating Experience and Techno-economic Benefits and Environmental Benefits of Energy Recovery from Renewable Waste Materials. Joint meeting of IEA Bioenergy Task 32, 33 and 36. Tokyo, Japan, 28 October 2003

<sup>307</sup> <http://www.outotec.com/products/energy-production/waste-to-energy-plants/>

<sup>308</sup> Outotec Energy Products Brochure. Outotec Oy. 2012.

type of gasifiers, the so-called “gasifier” and “advanced staged gasifier”, respectively, see Figure 61. A complete installation of a typical advanced staged gasifier is shown in Figure 62.

In both cases the design is based on stationary fluidized bed systems fitted with proprietary open bottom design to allow the extraction of ash and oversize material. These gasifiers have typically been used for mostly for clean biomass residues and in some cases waste fuel when air-blown<sup>309</sup>, but in a cooperation with APP, an oxygen-steam blown gasifier has been developed for use with plasma gas cleaning, see Section 7.4.2.1.

The advanced staged gasifier<sup>310</sup> is composed of a stationary fluidized bed gasifier at the bottom and an integrated thermal oxidizer on top of the gasification zone into which additional combustion air is injected. Other proprietary features are a fully refractory lined combustion chamber in a steel casing, the use of partly coated in bed/vapor space tubes for avoiding hot spots in the bed area, a bed extraction, sieving and reinjection system to remove agglomerations, and membrane walls in the flue gas path to reduce temperatures and therefore protect superheaters from chlorine corrosion.

---

<sup>309</sup> Outotec Energy Products Installation List 2017

<sup>310</sup> Status of Planning and Construction of Gasification Plants in the United Kingdom. Timothy Kast, Jim Starkey, Matthew Pierson and Michael L. Murphy. Waste Management, Volume 7. 367-378. Waste-to-energy. Editors: Karl J. Thomé-Kozmiensky et al. TK Verlag, Nietwerder, Germany 2017

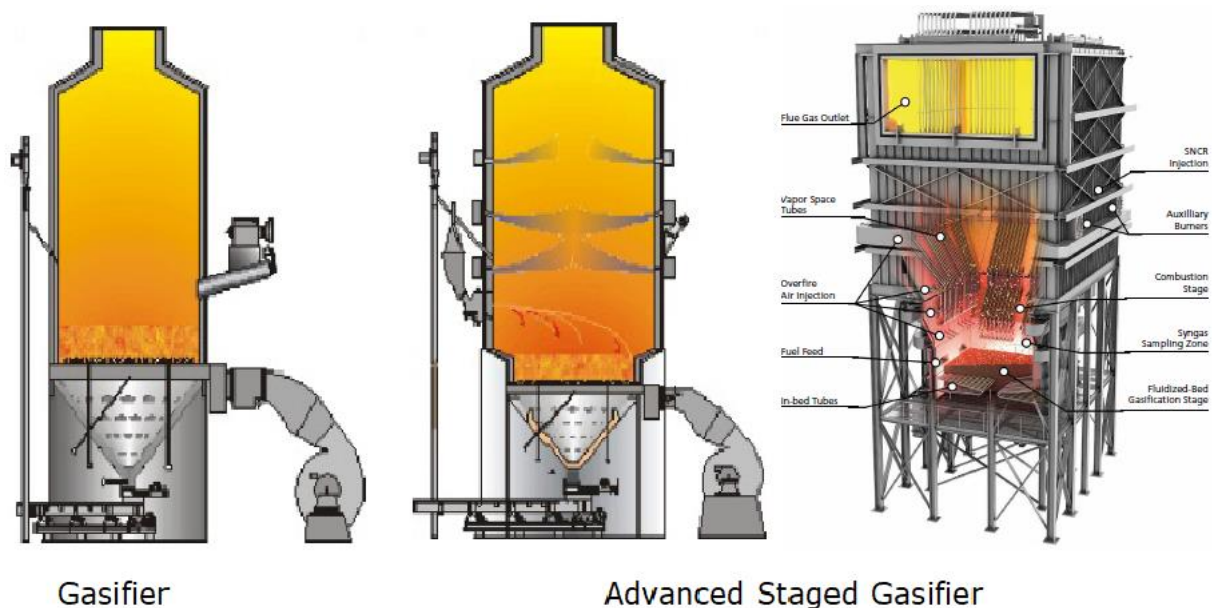

**Figure 61** Outotec "gasifier" and "advanced staged gasifier" (adapted from<sup>308, 310</sup>)

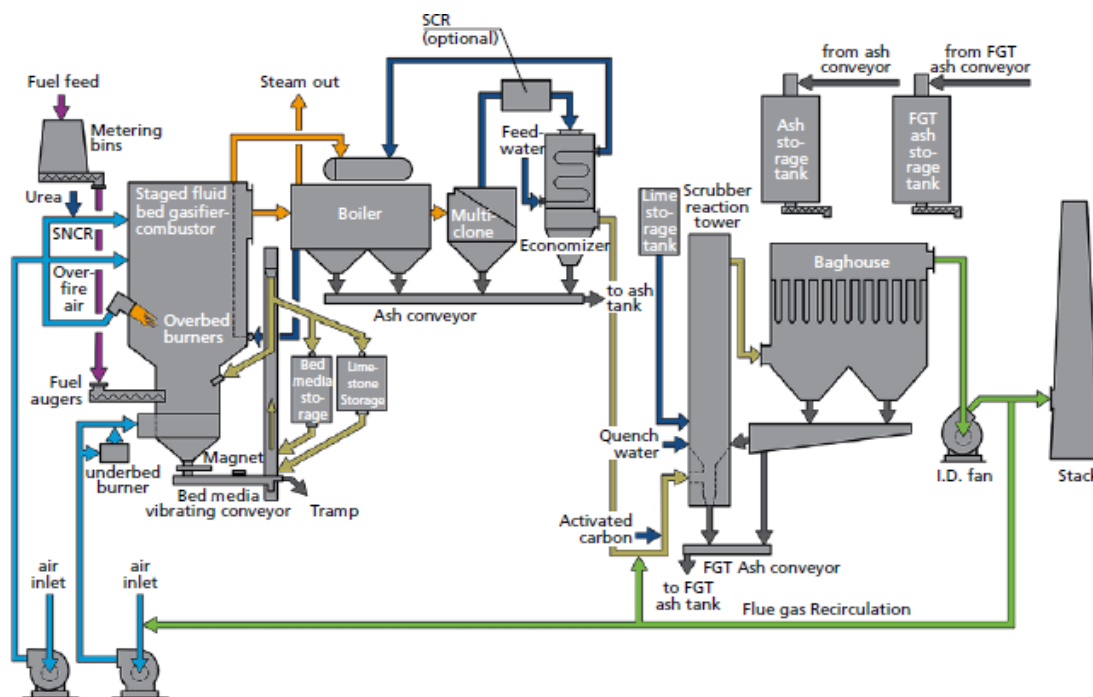

**Figure 62** A typical Outotec complete advanced staged gasifier installation<sup>310</sup>

Fuel preparation to a size below 100 mm in any direction and removal of rocks, metals, etc., is required. Processed fuel is delivered to a dual-screw metering bin located adjacent to and elevated above the gasifier. At the gasification stage, solid fuel is fed to an atmospheric bubbling fluidized bed by means of a specially designed fuel feed auger that introduces the fuel directly into the bed, whereby the fuel is retained in the bed longer and reduces the need for secondary air in the gasifier. Bed material is continuously withdrawn through the bottom, a horizontal open grid in a uniform way and is cleaned from non-combustible and non-fluidizable material, and the accepted fraction is reinjected back into the bed. There are no moving parts within this gasification zone, thus it is claimed to be very reliable.

Fluidizing gas is fed from below the grid. The fluidizing air as well as the secondary and tertiary air streams are also mixed with recycled flue gas to control temperatures and oxygen content in the flue gas. The heat generated by partial oxidation with air results in the volatilization and gasification of the remainder of the fuel to produce a combustible "product" gas. The reduced air flow to the bottom of the fluidized bed, requiring higher pressure than secondary or tertiary air, reduces the parasitic power load.

As the combustible gas leaves the bed and flows upward into the combustion zone, secondary and tertiary combustion air is added via successive horizontal rows of overfire air (OFA) nozzles. Through this staged combustion approach, the oxygen equivalency in the bulk gas stream increases in a controlled fashion up to the final excess air level in order to manage the gas temperature profile and reduce the production of NO<sub>x</sub>. NO<sub>x</sub> emissions are controlled at the upper region of the combustion chamber by a SNCR system where a series of lances inject aqueous ammonia or a urea-water solution into the flue gas, and the reaction proceeds in the furnace, the boiler inlet duct and first boiler pass. Combustion of the syngas, condensable hydrocarbons and any remaining or entrained solid fuel takes place in this region and provides additional heat energy, raising the temperature of the flue gas. The controlled, final flue gas temperature is selected to optimize SNCR performance, boiler performance and ash fouling and slagging behaviour.

Within the gasifier and oxidizer reactor, steam-generating water tubes are typically installed to extract heat from the bed, the furnace, or both to improve overall boiler efficiency. In this way the fuel specification (low or high energy content, etc.) of a project can be compensated and the air flows adjusted for a reasonable excess air (in the UK projects, typically in-bed tubes are not installed, and the freeboard is extended somewhat in order to allow the measurement of, and to improve the gas heating value in the in the freeboard to meet gasifier definitions).

The flue gas from the reactor furnace flows to a modular, steam-generating, waste heat boiler through a transition duct. The boiler is of a water-tube type and is arranged in successive evaporative or superheat tube bundles to produce the final superheated steam. The design steam conditions are typically limited to 4.5 MPa and 400 °C. An evaporative screen section is placed first in the flue gas path to reduce the flue gas temperatures into the superheater, and parallel flow is typically used in the superheater and soot blowers are used.

A multicyclone unit is located immediately after the boiler exit at 290 to 370 °C to collect a significant portion of the total entrained fly ash. This design facilitates the use of an SCR, if needed. But the disposal cost of such fly ash, relative to the disposal cost of flue gas cleaning solids residues, motivates the additional cost for separate removal of this fly ash.

The flue gas cleaning typically includes a wet-dry or dry scrubber reaction tower for acid gas removal, using lime or hydrated lime as a reagent, followed by a fabric filter for dust control. Pulverized activated carbon (PAC) can also be injected upstream of the filter.

Outotec has installed over a dozen advanced staged gasifier installations, of which half of the projects are from recent years in the UK that are in construction, commissioning and early operation, See Appendix 4.

### **7.3.2. Waste gasification with gas cleaning, "true gasification"**

In this section, different forms of waste gasification plants for the production of power or power and heat where partial and full gas cleaning has been or is used.



### 7.3.2.1. Air Products, Teesside, UK

In 2009, Air Products and AlterNRG signed a joint development agreement giving Air Product rights to license AlterNRG's gasification technology<sup>311</sup> for energy projects. In July 2010, Air Products announced<sup>312</sup> its intention to build a plant to convert pre-processed waste to 49 MW (gross) electric power at a location at Tees Valley close to Billingham using gasification technology provided by AlterNRG, benefiting from the UK RO (Renewable Obligation Order) system<sup>313</sup>. The power would be sold under a long-term contract with a third party. In February 2011, a planning application was made to the Stockton Council that was approved later that year<sup>314</sup>. The Environmental agency permit was received in April 2012<sup>315</sup>. However, due to an oversight of the Renewable Obligation system with potential implication on the future number of ROCs received per MWh, the outcome of which was not made public until July 2012<sup>316 317</sup>, the final investment decision<sup>318</sup> only came in August 2012. This plant was said to have a cost of 500 million \$US and would start operation in 2014<sup>319</sup>. In late 2012, the company announced its intentions to build a second, identical facility on a plot adjacent to the first plant<sup>320</sup> and a planning permission was received in the first half of 2013<sup>321</sup> and also an Environmental Agency permit<sup>322</sup>. At the end of 2013, Air Products entered a 20-year power purchase agreement with the UK government to sell the plant output, 37 MW<sub>e</sub>, as of 2016 for use by government bodies at fixed, undisclosed rate<sup>323</sup> as part of the government's Energy for Growth project.

The construction of this second plant, Tees Valley 2 (TV2) started in April 2014. The commissioning of the first plant TV 1 started with some delay in the first part of 2015<sup>324</sup>. In the beginning of November, Air Products decided to suspend the on-going construction works on the TV2 plant and dismissing the work force "certain design issues of the first project are understood, remediated, and can be efficiently integrated into the design of the second project". The start-up had then been postponed to mid-2016<sup>325</sup>.

Eventually, in April 2016, Air Products announced<sup>326</sup> its intentions to leave the energy from waste business and would suffer from a write-down in the range of 900 million to 1 000 million \$US. It was noted in the press release that the company had communicated the challenges with the projects and that testing and analysis indicated that "additional design and operational challenges would require significant time and cost to rectify". Consequently, the board of directors decided that "it is no longer in the best interest of the Company and its shareholders to continue the Tees Valley projects". All work on the site was halted and attempts were and are being made to sell the facilities, so far to no avail. Very little is known about the causes of this decision, and the little information available is related further below after the technology description.

Air Products partnered<sup>327</sup> with Impetus Waste Management (IWM), who bought the North Tees site in 2005. It operates and owns both non-hazardous and hazardous landfills. The company manages approximately 900,000 tonnes waste per year at the Bran Sands and Cowpen landfill sites. The

<sup>311</sup> Air Products Press Release 4 February 2009.

<sup>312</sup> Air Products Press Release 20 July 2010.

<sup>313</sup> [www.legislation.gov.uk/uksi/2009/785/contents/made](http://www.legislation.gov.uk/uksi/2009/785/contents/made)

<sup>314</sup> Stockton on Tees Planning Permission references 11/0359/EIS

<sup>315</sup> Environmental Agency Permit Number EPR/JP3331HK. 20.04.2012

<sup>316</sup> Facility to convert energy from landfill waste may not go ahead. The Guardian 11 August 2011.

<sup>317</sup> ROC and ROLL: Shaking Up UK Renewables. Waste Management World. 01.11.2012

<sup>318</sup> Air Products Press Release 7 August 2010.

<sup>319</sup> Strategy for Success Innovation, Integration and Improvement. Onsite Model Innovation: Energy from Waste. Investor Call Slides. 07 August 2012

<sup>320</sup> Air Products Press Release 23 October 2012

<sup>321</sup> Stockton on Tess Planning Permission reference 13/0780/EIS

<sup>322</sup> Environmental Agency Permit Number EPR/XP3336NN

<sup>323</sup> New energy deal to save £84m from government bill. UK Government Cabinet Office. 10 April 2013

<sup>324</sup> World's largest' gasification plant nears completion. Let's recycle. May 19, 2015

<sup>325</sup> Up in the air. Matt Clay. Recycling & Waste World 27 May 2016

<sup>326</sup> Air Products Press Release 4 April 2016

<sup>327</sup> Air Products Proposed Renewable Energy Facility in Tees Valley. Roger Dewing, Air Products 28th February 2011

company would provide the RDF from pre-treated household, commercial and industrial waste currently sourced in the North East and destined for landfill in Teesside. Most of this will come from the region but up to a quarter could also come from other landfills outside of the region.

Each of the TV facilities, see Figure 63, was planned to convert 350 000 tonnes of pre-sorted wastes per year and produce 49 MW<sub>e</sub> gross, 37 MW<sub>e</sub> net of electric power via two Solar Titan 150 gas turbines, see Figure 63. The plant definition was defined by the scope of supply of AlterNRG, gasification island design, engineering and equipment supply and the FEED design of AMEC Foster Wheeler.

In addition to RDF, the gasifier operation<sup>314, 321, 328</sup> requires limestone as a fluxing agent and metallurgical coke as a support for the fixed bed and energy source at a rate of approximately 14 % and 4 %, respectively. Since the coke has a higher energy content than the RDF, it contributes to around 10 % of the energy input. The material handling and storage systems receive and process these materials at the facility. The system will include RDF unloading facilities from trucks, receiving pits, day bins, conveying and waste shredding to below 300 mm as well as metallurgical coke and limestone truck unloading, storage silos, and coarse crushing, respectively.

The RDF, at a rate of approximately 950 tonnes/day, coke and lime are metered onto a common charge conveyor which transports the feedstock to the gasifier, and where it is charged into the gasifier, Figure 64, from the side. The gasifier is a refractory lined vessel, 9 m in diameter and 25 m high operating at close to atmospheric pressure.

The materials will move downward in the gasifier and undergo pyrolysis and gasification reactions as it reacts with controlled amounts of oxygen introduced immediately above the plasma torches. Oxygen and nitrogen are supplied from an off-site installation. At the bottom the material is heated by plasma torches to temperatures over 3000 °C. The power consumption of the plasma torches corresponds to 2% - 5% of the total energy input to the plant.

This high temperature converts any remaining organic component while the metallic and inorganic content of the feed material forms molten slag, which flows out at 1650 °C through the tap holes at the bottom of the gasifier. The slag is then quenched and granulated upon exiting the gasifier. The resulting vitreous granules, that can be up to 25 % of the weight of the RDF feed, depending on ash content and lime addition, are conveyed and loaded onto trucks for export for use as various forms of construction material and additive.

The raw product gas goes upwards in the gasifier shaft counter-currently to the solids and enters the dome that gives additional residence time at high temperature to completely destroy tars. The high temperature inside the plasma gasifier is claimed to result in the complete destruction of tars. The product gas exits the gasifier at 950 °C and is partially quenched with atomized water at the top of the gasifier prior to exiting the gasifier through two nozzles. It is further quenched and cooled at ambient temperatures through a caustic Venturi quench and scrubber system. Besides particulates, also chlorides and some ammonia will be removed at this stage.

The claimed advantages of the plasma gasifier include<sup>327, 328</sup>;

- Ability to gasify blended feedstock including waste
- High temperatures with a higher degree of temperature control
- Ability to control syngas H<sub>2</sub>/CO ratio through adjustment of O<sub>2</sub> addition and torch power

<sup>328</sup> Summary of Qualifications. Alter NRG Plasma Gasification Solution. AlterNRG. April 2018

<sup>328</sup> Plasma Gasification: Lessons Learned at Ecovalley WtE Facility. Ken P. Willis, Shinichi Osada, Kevin L. Willerton. Proceedings of the 18th Annual North American Waste-to-Energy Conference NAWTEC18 May 11-13, 2010, Orlando, Florida, USA. NAWTEC18-3515

- Complete reduction of tar in the gas
- Controllability
- Low cost of installation
- Ash is vitrified

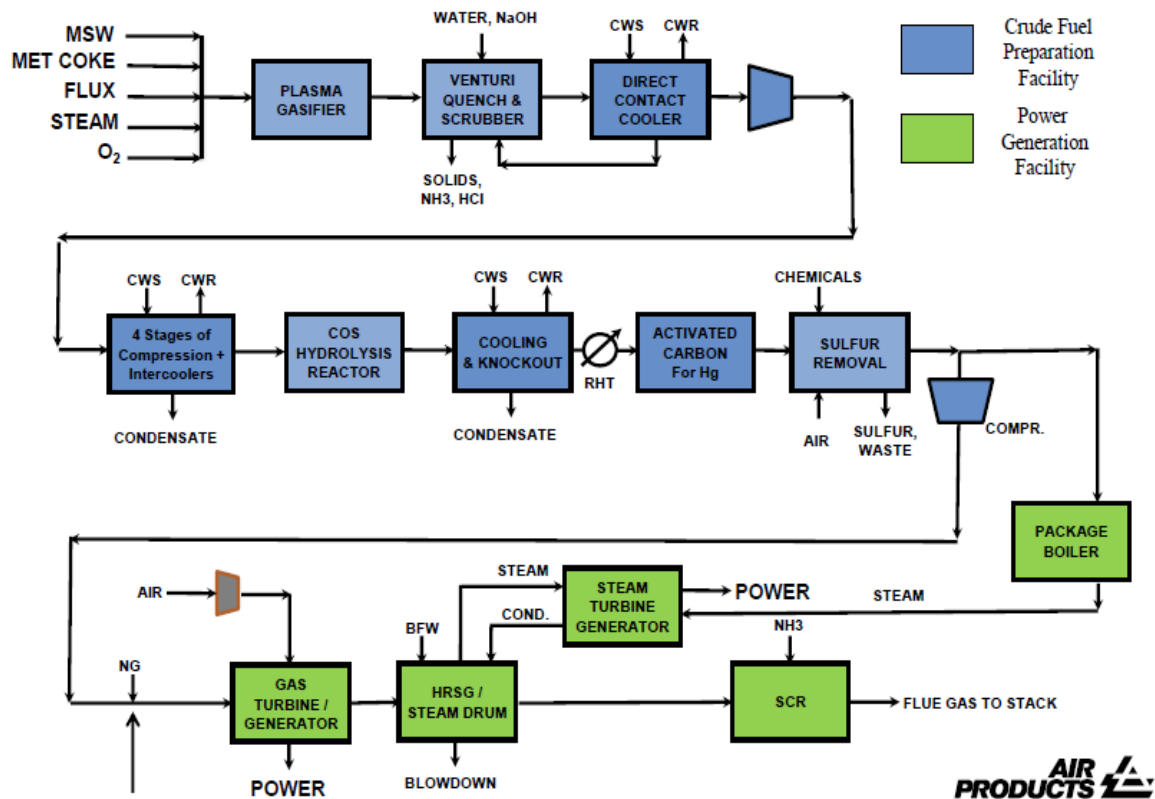

**Figure 63 Process schematic for the Air Products TV1 and TV2 plants<sup>327</sup>**

AlterNRG and Westinghouse plasma technology have been developed over a period of over 30 years<sup>328</sup>. The technology was initially developed by Westinghouse in collaboration with NASA as part of the Apollo space program as NASA wanted to simulate high temperatures space vehicle re-entry in to the earth atmosphere. Later, Westinghouse and the Electric Power Research Institute (EPRI) developed a reactor using plasma for reclaiming fragmented scrap metal from 1983 to 1990. During this period Westinghouse extended the for the treatment of hazardous waste. In the mid-1990s Westinghouse cooperated with Hitachi Metals on an R&D program and pilot testing program that eventually led to the first commercial gasifiers in Japan at the turn of the century. By mean of a management buy-out Westinghouse Plasma Corporation was founded in 1999.

In 2007, AlterNRG, itself founded in 2006, bought the company and continued in the development and commercialization process. In 2015, a Sunshine Kaidi New Energy Group Co subsidiary in the USA, Harvest International New Energy Co Ltd took over AlterNRG.

Alter NRG Plasma Gasification has been and is used commercially in a handful of installations in addition to the Tees Valley plant. A report<sup>329</sup> from 2008 gives further information on the process and performance data (e.g. typical M&E balance) and on installations available up to 2008.

<sup>329</sup> The AlterNRG/ Westinghouse Plasma Gasification Process. Juniper Consultancy Service Ltd. November 2008



**Figure 64 The AlterNRG plasma gasifier<sup>328</sup>.**

From 1983 to the end of 2014, Westinghouse Plasma Corporation and its successor AlterNRG owned and operated a 2 tonnes/h demonstration facility at Madison, PA, USA. This flexible plant with three feeding systems, gasification reactor and downstream gas cleaning equipment as well as gas analysis equipment has been important for developing the process, for testing of large number of fuels and optimization of operating conditions and to provide data on emissions and by-products for permitting purposes, including tests for the Air Products Tees Valley project.

Together with Hitachi, a 24 tonnes/day external non-transferred torch "pilot" plant was built in Yoshii, Japan and operated for a demonstration period in 1999-2000 in which the product gas was sent to a waste heat boiler. This plant gave the basis for a Japanese approval of the technology for waste to energy and was the basis for two additional plants in Japan.

The Mihama-Mikata plant processes since 2002 20 tonnes per day of local MSW and 4 tonnes per day of sewage sludge. The product gas is used to produce heat which is then used to dry the sewage sludge as a pre-treatment to the gasification process. The slag by-product is used as aggregate added to construction materials.

The EcoValley plant, at Utashinai on the island of Hokkaido, Japan, had two gasifier trains each capable of processing 100 tonnes per day. Originally it processed ASR and MSW but later only process MSW. The operation started in 2003 and was continued to 2013, when the waste supply contract ended. The scale-up from pilot plant (a factor of 1:2 from Madison and 1:4 from Yoshii, respectively) to Utashinai was not smooth and the plant's design and equipment had to undergo significant re-engineering and modifications in order to achieve its intended function<sup>328, 330</sup>. This involved optimization of the diameter of the bottom section to improve the temperature distribution, changing the refractory materials in the melt zone to have a life-time of several years and to avoid

<sup>330</sup> Early Evolution of the Westinghouse Plasma Gasifier – Lessons Learned from Eco Valley, Japan. Shinichi Osada. Alter NRG Open House, June, 2015

short-cut direct carry-over of particulates from the feed point to the gas exit in the cupola section. This led to changes that were implemented in the TV plant design, such as moving the feeding point to a lower position and feeding from the side instead of top feeding in the cupola to decrease the particle content in the raw product gas at the outlet and, by partial quenching at the gas outlet, solidify any molten or sticky particles to prevent any build-up of material on the wall of the exit pipe.

The Maharashtra Enviro Power Ltd. plant processes hazardous wastes 70 tonnes per day from over 30 industries in India since 2009. The owner of the plant, SMSIL, is a partner of Alter NRG and together the companies offer plasma gasification into the Indian market. WPC has access to the operational data and the operating staff at the plant. SMSIL also makes the plant available to certain Alter NRG customers for pilot tests and optimization tests.

In 2013, Wuhan Kaidi, a large Chinese energy company in Wuhan, Hubei China, began operating a 140 tonnes per day biomass gasification facility to produce power and liquid fuels.

The latest installation, that started operation in 2014 GTS in Shanghai, China is processing incinerator and industrial and medical wastes to convert it into a fuel gas and a vitrified slag.

There is also reference to a plant in construction by Uthong, the UTPE Waste to Energy Facility, to process 600 tonnes/day of pre-sorted MSW in 2 lines and produce 20 MW<sub>e</sub> net electricity through a steam cycle power island configuration. The plant is expected to start up in 2019, but no additional information has been found.

All of the above plants can be classified as more or less two-stage incinerators or have partial gas cleaning to remove particulates and HCl, but not fitted with the same gas cleaning as was planned for the TV plants to meet primarily IED requirements and secondly to meet gas turbine contaminant tolerances.

Following the quenching and removal of particulates in the AlterNRG scrubbing system, the gas will be further cooled in a direct contact syngas cooler to condense additional water followed by a wet electrostatic precipitator (WESP) to remove droplets and any particulates remaining in the gas, such that the gas is suitable for compression to an intermediate pressure, followed by final pressurization in a four-stage compressor to the gas turbine inlet pressure. Following pressurisation, the gas is reheated and passes a COS hydrolysis reactor, in which a catalyst is used to convert COS to H<sub>2</sub>S to facilitate the downstream sulphur removal unit, given the fact that COS is far more difficult to remove by comparison. The catalytical hydrolysis unit also hydrogenates olefins and HCN to NH<sub>3</sub>. The gas is then again cooled and further water is condensed. After reheating to move away from the dew point, mercury is removed in a bed of activated carbon. Finally, the gas is cleaned from H<sub>2</sub>S in a Lo-Cat liquid scrubbing process (see Section 6.2.5) where H<sub>2</sub>S is removed by an alkaline solution containing ferric ions oxidizers to convert it to elemental sulphur. In an aeration vessel, the ferrous ions are regenerated while the sulphur particles are separated by flotation. The cleaned gas produced<sup>327</sup> has an energy content of < 8 MJ/m<sup>3</sup>.

The clean syngas then proceeds downstream to a common delivery header joining an existing asset, which is a common boiler used as an auxiliary boiler and two Solar Titan 130 GTs of 17 MW<sub>e</sub> power output each. The gas turbine exhaust gases are routed to a common heat recovery steam generator for heat recovery as superheated high-pressure steam that is used in a condensing turbine generating the balance of power up to the 50 MW gross output. The major parasitic loads on the site are the gas compressor, the plasma burners as well as pump power in the cooling water and gas cleaning sections, whereas the consumption for the air separation unit is an off-site.

In the heat recovery steam generator (HRSG), there is an SCR system for NO<sub>x</sub> reduction, as the low calorific value of the gas does not allow the use of the conventional lean firing gas turbine burner technique for NO<sub>x</sub> reduction. With the combination of scrubbing, hydrolysis and sulphur removal as well as SCR, the WID/EID limiting emission values can be met. Process condensate is pre-treated on site prior to being discharged to the sanitary sewer for treatment in a waste water treatment plant off-site.

The plant has a flare for combustion of excess gas under upset conditions and start-up/shut-down and a cooling tower system for the cooling of the gas processing section and steam turbine condenser.

As for the details of the technical issues that led to the project failure, little is officially known. As for concrete causes, a construction worker's union representative has revealed that the plasma gasification system in the TV1 facility eroded the gasifier walls through the combined action of heat and acids, that tests had been "blowing big holes" in the ceramic lining of the gasifier and that parts were taken from TV2, TV1's sister plant, in order to try to fix TV1, but to no avail<sup>331</sup>. Another contributing factor mentioned is the mechanical handling systems<sup>332</sup>. Then there is some more general attribution of causes in the cited reference, such that the scale-up factor for the AlterNRG system "from experiences at demonstrators at 10 000 tonnes/year to Tees Valley at 350 000 tonnes/year" was higher than the normally experience recommendation of a factor of 10 maximum (however, the Utashinai plant was upscaled from 8 000 tonnes/year in Yoshii to around 35 000 tonnes a year, and the TV1 plant is 350 000 tonnes/year so scale-up factor was 4 and 10 respectively, author's comment). Another very obvious contributor to the economic losses was that the construction on TV2 began before the technology of TV1 had even been finished and proven, such that any engineering or procedural flaws were iterated, with no chance for lessons learned and experience improvements<sup>325</sup>. One factor of quite some importance to not pursue the work which has not been mentioned by others is that under the RO obligation, which was basis for receiving revenues from ROCs, the TV1 plant was contracted required that the power generation must start before March 31, 2017 to obtain ROCs. After this date, the CfD auctioning system would be applicable. So, if the "additional design and operational challenges would require significant time and cost to rectify<sup>326</sup>", to the extent that TV1 was judged to bring the start of generation beyond March 2017, the ROC revenue stream was no longer available and bankable, which most certainly was valued into the process.

### **7.3.2.2. CHO Power<sup>333</sup>, Morcenx, France**

CHO Power is a wholly owned subsidiary of Europlasma<sup>334</sup>. Europlasma was formed in 1992<sup>335</sup> as a spin-off from the aeronautics company EADS (*fka* Aérospatiale) where plasma technologies were developed as a tool to achieve very high temperatures for space applications and for melting of certain materials. Europlasma was formed to exploit the development of industrial applications of the plasma torch technology. One application identified was vitrifying the waste incineration ashes resulting from the incineration of waste that was developed in a pilot plant. In 1997 the company built a continuous ash vitrification plant of 10 tonnes/day for the city of Bordeaux, France at Cenon.

Based on this reference installation, the company became licensor to the Japanese companies Kobelco Eco-Solutions and Hitachi Zosen for four ash vitrification installations in Japan. In 2001, and following an IPO, Europlasma was listed on the Paris stock exchange (Alternex and since 2009 Euronext) and used part of the funds to buy into Inertam, an asbestos waste treatment operator at

<sup>331</sup> ENDS Waste & Bioenergy, April 6, 2016. <https://www.endswasteandbioenergy.com/article/1390261/reasons-tv1-failure-revealed>

<sup>332</sup> Energy-from-waste – A troubled technology. Rob Cockerill: Gas World 29 April 2016

<sup>333</sup> [www.cho-power.com](http://www.cho-power.com)

<sup>334</sup> [www.europlasma.com](http://www.europlasma.com)

<sup>335</sup> Europlasma. Document de référence 2017

Morcenx, Landes, France. In 2005, Europlasma raised over 25 million € from European private investors to expand in the cleantech business and to take-over Inertam, which expanded the asbestos treatment capacity with a new processing line. Furthermore, in October 2006, Europlasma bought Europe Environnement, a company specialized in gas treatment and odour abatement.

In 2007, CHO Power was formed to develop renewable energy projects, and to finance such developments Credit Suisse interests becomes a major stake holder in Europlasma. A new licensee, Kolon of South Korea, signed up for the ash vitrification technology.

In 2010, and after Europlasma raised additional financing the company, the construction of the CHO Power 11 MW<sub>e</sub> gross demonstration plant at Morcenx was initiated, the investment cost at the time being more than 45 million €. CHO Power also initiated an R&D cooperation with Kolbelco, named KIWI (also see below), to develop waste gasification technologies at the Morcenx site for three years. Also, in other business areas there was activity, a low-level radioactive waste vitrification unit was sold to Bulgaria. In 2012, the commissioning of the Morcenx plant began; however, it was aborted as some equipment, including the gasifier, did not meet expectations. A major reengineering program was initiated, see below. At the same time, the Group and its Japanese partner were conducting the first test campaigns with the KIWI pilot.

In 2013, and under the financial strains of the Morcenx reconstruction project, the company went into administration in February to undergo an internal reconstruction and where a debt composition settlement and refinancing was reached in July<sup>336</sup> and its board and management were restructured. Europlasma refocuses on its proprietary technologies by selling Europe Environnement and establishing three business areas: treatment of non-recyclable wastes (Inertam), plasma torch industrial applications (Europlasma Industries), and renewable power (CHO Power). The CHO Power emerges as the holder of IPR and project development resources independently of the CHO Morcenx plant special purpose vehicle company, and CHOPEX is formed as a daughter to CHO Power to become the O&M contractor for the CHO Power Morcenx and future plants.

In February 2014, the operations at CHO Power Morcenx were resumed and a preliminary take-over milestone was achieved in June after a 4 days availability test<sup>337</sup>. However, various re-engineering and bottleneck items were identified requiring further changes in the plant. The vitrification business received its first order from China. In addition, a major financial injection, 40 million €, was made.

In November 2015 the "delivery with reservations" milestone of CHO Morcenx was achieved after testing showing that the gasifier capacity sufficient to generate the nameplate power was reached (but not all engines have been installed, the power output was not demonstrated). In December, CHO Morcenx ordered<sup>338</sup> 2\*2 MW<sub>e</sub> GE Jenbacher (GEJ) engines to supplement the 2\*1 MW Caterpillar engines and 6 MW steam turbine installed in the plant already in 2012. The financing of the engines was achieved by an issue of convertible bonds. However, due to manufacturing time and installation time the engines were not installed on site and commissioned until the end of 2016, and the motor acceptance tests were made in early 2017. The engines did however only reach 1.5 MW due to a lower LCV of the gas than in the basis of design<sup>339</sup>. In June 2017, the final acceptance milestone was reached<sup>340</sup>. In parallel also other project of similar capacity have been developed in France, and where the final acceptance milestone in Morcenx was also a milestone in the development of such future projects.

---

<sup>336</sup> Europlasma Communiqué de presse: Reprise de cotation. September 26, 2013

<sup>337</sup> Europlasma Communiqué de presse 24.06.2014

<sup>338</sup> Europlasma Communiqué de presse 25 janvier 2016

<sup>339</sup> Europlasma Communiqué de presse 20 février 2017

<sup>340</sup> Europlasma Communiqué de presse 25 juin 2017

A process schematic of the present configuration of the plant at Morcenx is shown in Figure 65.



**Figure 65** Process flow schematic for the CHO Power process<sup>333</sup>.

The CHO Power process is claimed to accept a wide range of fuels, from non-hazardous ordinary industrial, commercial or domestic waste as well as refusal of ground vehicles to the most prepared biomass. The Morcenx plant uses construction and industrial non-hazardous waste and recycle wood, 52 000 tonnes per year. The waste is crushed, the heavy inert parts and metals are taken away, and the remainder is mixed in order to obtain a more homogeneous RDF fuel. The RDF is stored in a buffer storage.

The prepared SRF is introduced in the gasifier via a lock system to be transformed into gas. Originally the gasifier was the design of CHO Power and contained an integrated dryer and a sloping grate design, see right side of Figure 66. The air is fed through the grate and generates the heat for the gasification at 850 °C. This design proved early on in 2012 not to be feasible, and a decision was taken to replace it for a PRM Energy<sup>341</sup> KC-24 gasifier, which was effectuated in 2014. The reason for deciding on this particular technology has not been motivated but PRME and Europlasma had both been involved in the Eneria's, the French Caterpillar representative, gasification project in Moisanne in the beginning of the century by supplying a gasifier<sup>341</sup> and doing tests with the Turboplasma technology<sup>342</sup>, so there was already a connection.

The PRME<sup>®</sup> gasification technology<sup>341</sup> is a fixed grate, up-draft, sub-stoichiometric and multi-zoned gasification system that is available in a range of sizes to gasify 20 – 2 000 tons per day. Several installations for processing mainly various biomasses, wood wastes and agricultural residues are available for industrial application since 1982. The gasifier system, i.e. the supply to CHO Power, includes a fuel metering bin, fuel feed control, multi-zoned gasification air, the KC gasifier, water cooled ash discharge conveyors, utility piping and instrumentation/electronic controls to provide automated operation. A complete system also includes syngas cleaning process or staged combustion chamber. The gas can then be used as fuel gas or be in an ICE to generate power.

<sup>341</sup> www.prmenergy.com

<sup>342</sup> Succès des premiers essais de la technologie de gazéification de biomasse Turboplasma. Europlasma Communiqué de presse 9 septembre 2009



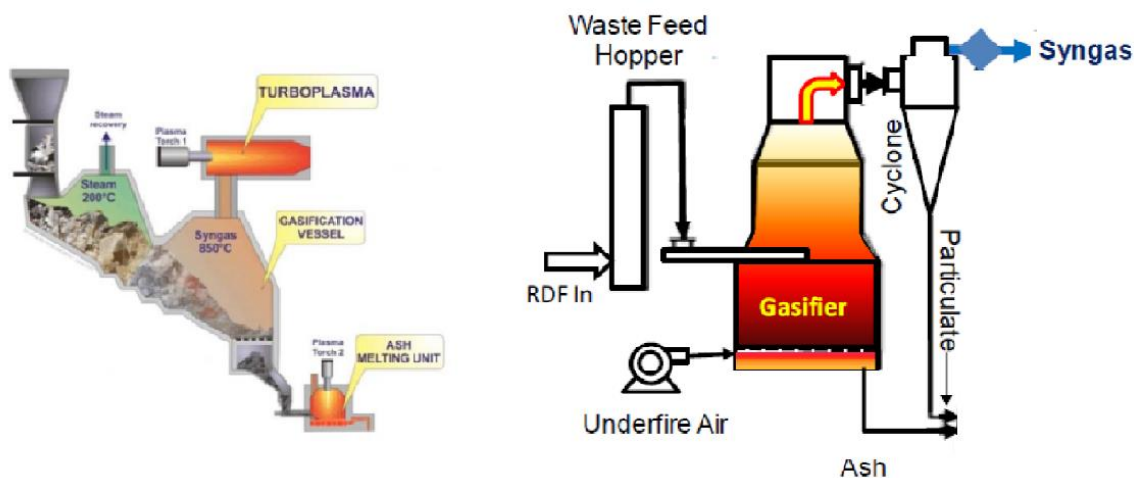

**Figure 66** The original CHO Power gasifier<sup>343</sup>, left, and the PRME replacement gasifier, right (adapted from<sup>344</sup>)

The fuel is metered to the reactor from the metering bin. This bin is equipped with an infeed levelling conveyor, level switches and a variable outfeed conveyor. The speed of the outfeed conveyor is automatically adjusted by the control system to maintain a predetermined temperature in the reactor. Metered biomass feed is transported into the reactor by a water-cooled screw conveyor, discharging into the lower portion of the gasifier reactor. The gasifier operates under a slightly negative pressure, eliminating fugitive emission of hot gases. The reactor is a vertical, cylindrical steel vessel that is lined with castable refractory. The proprietary shape of the reactor produces negligible entrained particulate matter and promotes mixing of volatilized combustibles, thus giving a means to control the residence time of the fuel within the reactor. Sub-stoichiometric air is admitted into the reactor via one or more zones and is controlled to volatilize the biomass while partially combusting the solids. When changing the gasifier in Morcenx, the quality of the gas deteriorated, which was compensated by the use of an oxygen addition to the air, as a measure for this plant and circumstances<sup>345</sup>. Ash exiting the reactor is discharged by a series of water-jacketed screw conveyors. Ash and other solid residues were planned to be vitrified in a plasma vitrification reactor. However, it appears that at present at least the fly ash is sent for disposal<sup>335</sup>.

The gas is afterwards brought to high temperature to be refined by tar cracking at 1200 °C or more in the Turboplasma reactor, a proprietary feature of the Europlasma/CHO Power technology. The gas is then cooled down and heat recovered to the steam cycle. As a cleaning measure, lime is injected into the gas to absorb HCl. The gas is then cooled down and filtrated in a bag filter to remove any particulates. Afterwards, the gas is quenched and steam is condensed. Following this the gas is slightly compressed and passes a bed of activated carbon for removal of H<sub>2</sub>S at 50 °C. At the end of this stage, a clean product gas is obtained, which is routed to the engines or an auxiliary boiler. In Morcenx, as noted above, there was originally 2\*1 MW Caterpillar engines installed, and only in 2016 was the full set of engines installed when also 2\*2 MW GEJ engines were operative on the site. The auxiliary boiler produces steam from the combustion of any gas not consumed by the engines. Also, there is heat recovery to the steam system on the exhaust gas system. There is no SCR system installed on the engines.

<sup>343</sup> CHO-Power: Production d'électricité par gazéification. EUROPLASMA, Nov 2008.

<sup>344</sup> Gortadroma Waste to Energy Gasification Facility Briefing. Cadence EnviroPOWER. July 2015

<sup>345</sup> Réponse de question de la publique. CHO Tiper, 8 juillet 2015

The steam is passed through a steam turbine to produce an additional 6 MW of electric power. To boost the efficiency, also heat from the turbine condenser, the engines and from other coolers, amounting to 17-18 MW, is collected and exported to a neighbouring industry for use in a wood dryer. A photo of the plant is shown in Figure 67.

Power is sold to EDF under a 20-year guaranteed-price contract<sup>346</sup> at base tariff of 125 €/MWh plus an efficiency bonus of 1 €/MWh for each additional percentage point of output above a total (electrical + thermal efficiency) of 50%. Hence, the sales of heat not only generate a direct revenue, it also indirectly augments the power sales price. So, for a nominal 75 % efficiency, the actual power sales value becomes 150 €/MWh.



**Figure 67 The CHO Power Morcenx plant<sup>347</sup>**

Despite of the positive press release, when looking at the actual production (see Table 28), it is clear that the plant is still in campaign operation and also very far from producing the expected amounts.

**Table 28 Reported production figures of the CHO Morcenx plant.**

Production	2014 <sup>348</sup>	2015 <sup>349</sup>	2016 <sup>351</sup>	2017 <sup>335</sup>	2018 to June
MWh electric	2 222	1 975	4 632	5 196	2436
MWh heat	16 866	14 153	21 089	22 052	n.a.

Assuming a gross generation of 8 MW for 7 500 hours up to 2015, and 12 MW thereafter when the new engines are installed, this would amount to 60 000 MWh power and 90 000 MWh, respectively. It also appears that the Caterpillar engines are not in operation at present. These were supplied by

<sup>346</sup> Europlasma. Alphavalue Corporate Services. August 8 2018

<sup>347</sup> Courtesy of CHO Power

<sup>348</sup> Europlasma. Document de référence 2014

<sup>349</sup> Europlasma. Document de référence 2015

<sup>350</sup> Europlasma. Communiqué de presse, le 21 juin 2018

Eneria based on a rental agreement lasting until 2019<sup>351</sup>. It also appears that the plant has undergone a derating from the original 12 MWe<sup>352</sup> gross to first 11 MWe<sup>351</sup> and now 10 MWe<sup>334</sup> gross. The derating of the GEJ engines, in total 0.5 MW per engine, can be one reason for this, but also the Caterpillar units would suffer from a lower gas LCV, and, as noted above, may actually no longer be in use.

As for the balance of gross power generated and the internal consumption of the plant, these values have not been found for Morcenx, and the records show that over the years the plant has consumed more energy than produced, which is also a sign that the operational time has been limited. However, for the Tiper and Locminé projects, that are very similar in capacity to Morcenx but with somewhat evolved technology such data are available, see below.

Regarding emissions, the annual reports cited in the table above indicates that the limiting emission conditions of the WID/EID can be contained without any special issues. Unlike e.g. the Air Products plant, there is no SCR used to control NO<sub>x</sub>. The thermal plasma treatment may also reduce the fixed nitrogen compounds in the products gas, which together with allow heating value of the gas.

The Tiper<sup>353</sup> (Thouars, Deux-Sèvres) and the Locminé<sup>354</sup> (Locminé, Morbihan) projects are both in development but have reached further than another handful of projects both inside and outside France. Both are nominally 11 MWe gross and the process is similar to what is described above. There is interesting technical data in the permit applications<sup>355, 356</sup> submitted by CHO Power.

The fuel fed to the gasifier has an LHV of 16 MJ/kg at 20 % moisture and 10-15 % ash. The gasifier nominal throughput is 8 tonnes per hour or 36 MW. The gas produced has the nominal composition as shown in Table 29.

**Table 29 CHO Power average bulk gas composition, dry basis<sup>355, 356</sup>.**

Average bulk gas composition	
Component	Vol %, dry basis
CO	11
CO <sub>2</sub>	10
CH <sub>4</sub>	0
H <sub>2</sub>	8.5
C <sub>2</sub> H <sub>2</sub>	2.6
N <sub>2</sub>	53
LHV MJ/Nm <sup>3</sup>	3.9 MJ/Nm <sup>3</sup> (estimated based on composition above)

Both plants use a combination of engines, typically generating 6.7 MW electricity altogether, and auxiliary boiler as the gas consumer, and have steam turbine bottoming cycles generating 2.5 MW. The steam conditions for the steam turbine are not mentioned. In both cases, there is no natural heat consumer at hand, instead, the heat produced will be used for drying of wood material for later use as a fuel in the plant or externally. The quantity of heat seems to be in mismatch in relation to the dryer throughputs of 50 000 tonnes per year. When it comes to the overall data on generation and efficiency etc., these are collected in Table 30 and Table 31.

<sup>351</sup> Europlasma. Document de référence 2016

<sup>352</sup> Europlasma. Communiqué de presse, le 9 juillet 2012

<sup>353</sup> www.chotiper.fr

<sup>354</sup> cholocmine.fr

Although the efficiency reported is high, 29 % and 34 % respectively, these are based on gross generation. But, as the plants own parasitic consumption is high, 35-40 % of the gross generation, the net generation efficiency comes down to more modest numbers, 17-22 %, and comparable to an ordinary incinerator at small scale. The internal power load is 90 % related to the gasification process. The main power consumers that can be identified are the Turboplasma torches, the gas compressor and pumps.

**Table 30 Energy balance for Tiper<sup>355</sup> and Locminé<sup>356</sup>, GWh/a**

GWh/a	Production			Consumption			Net	Heat
Unit	Gas engines	Steam turbine	Total	Fuel handling	Gasification process	Total	Net generation	Heat produced
<b>Tiper</b>	60	18	78	2	26	28	50	86
<b>Locminé</b>	50	19	69	2	26	28	41	123

**Table 31 Energy balance for Tiper<sup>355</sup> and Locminé<sup>356</sup>, GWh/a**

	Fuel			Efficiency, gross %. (kWh/tonne)			Efficiency, net % (kWh/tonne)	
	To site ktonnes	To plant ktonne	To plant	Power	Heat	Total	Power	Heat
<b>Tiper</b>	57	51	227	34 (1 530)	38	72	22 (980)	38
<b>Locminé</b>	61	55	244	29 (1245)	51	80	17 (745)	51

Regarding the status of the project development, permits appear to have been secured for both projects, after some local opposition and debate. There has also been some criticism of the Europlasma group in stock market follower's chat fora. An uncertainty that affects both projects is that the former obligation of EDF to buy renewable electricity, as was the case of CHO Morcenx, is undergoing a revision and that a new system based on a market plus premium will be introduced, the details of which are not clear at the moment. This has stalled decisions in wait for clarifications.

The investment in the plants has been cited to 60 million € and to 48 million € for the Tiper plant<sup>353</sup> and for the Locminé plant<sup>354</sup>, respectively. The Tiper project seems more advanced than the Locminé project, as substantial parts of the financing already seem to be in place<sup>357 358</sup>. The French environment and energy management agency Ademe has committed 12 million € to the project and further support has been granted by the Conseil Régional of Nouvelle Aquitaine 2 million €. Furthermore, in early 2018 an agreement was signed with the EIB for 30 million € in debt financing, and in addition also a non-quantified support from InnovFin – Energy Demonstration Projects (EDP), a part of the Horizon 2020 program also managed by EIB. In conjunction with these external financing activities, there has also been a restructuring of the financial situation of CHO Power and CHO Morcenx in relation to one of the main financiers that reduces the loan service cost of CHO

<sup>355</sup>CHO TIPER Gazéification Dossier de demande d'autorisation d'exploiter une usine de gazéification. Impact et Environnement. Chapitre II – Etude d'impact

<sup>356</sup> CHO Locminé Dossier de demande d'autorisation d'exploiter une unite de production d'énergie par gazeification

<sup>357</sup> Europlasma. Communiqué de presse, le 20 décembre 2017

<sup>358</sup> Europlasma. Communiqué de presse, le 28 mars 2018

Morcenx and financially strengthens CHO Power<sup>359</sup>.

Regarding the cooperation with Kobelco, KIWI (Kobelco Industrial CHO-PoWer Gasification) that was announced in 2010, the purpose was to validate a new process for gasification of waste based on the Kobelco fluidized bed technology and the Turboplasma technology, respectively. The KIWI program had a duration of 3 years and 6 million € in financing<sup>360</sup>, part of which was from public and regional sources. An 800 kg/h pilot plant, Figure 68, was constructed at Morcenx and tests of fuel gasification and tar reduction were successfully made<sup>361</sup> from 2012 to 2015. However, it is not clear whether these tests went into the second phase, a proof-of-concept testing on one of the 1 MW Caterpillar engines on the Morcenx site. The project closed in 2015<sup>349</sup>, and neither are there any status changes nor follow-up activities mentioned later annual reports<sup>335, 350, 362</sup>.

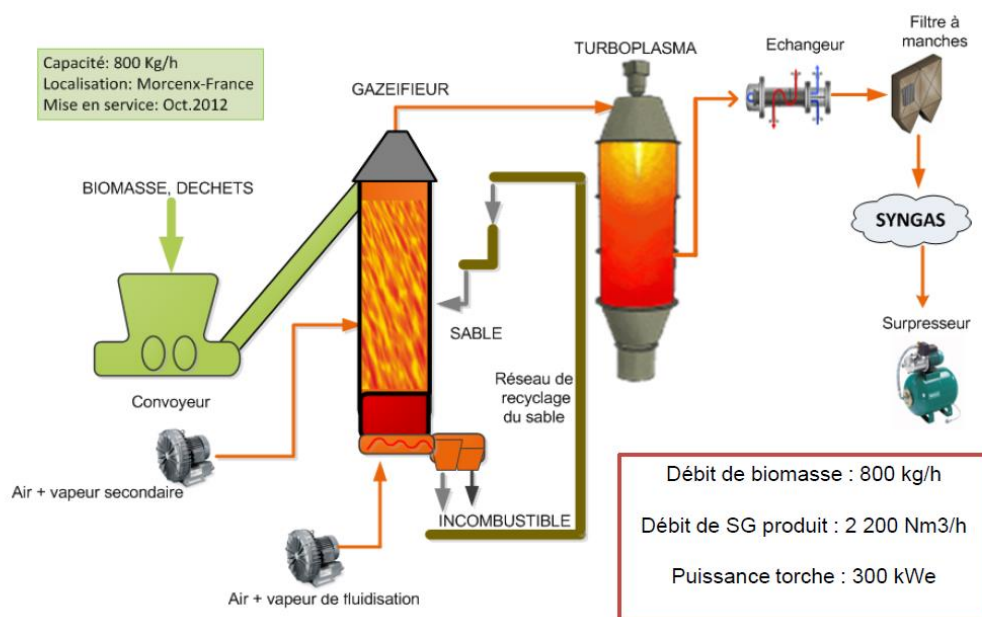

**Figure 68 The KIWI test facility<sup>361</sup>**

### 7.3.2.3. Concord Blue<sup>363</sup> (fka Blauer Turm aka Blue Tower)

The "Blauer Turm" or "Blue Tower" technology goes back to 1999 when the company D.M.2 Verwertungstechnologien Dr. Mühlen GmbH & Co. KG was formed by Dr. Heinz-Jürgen Mühlen and associates to develop a thermochemical process, "staged reforming", for the conversion of biomass and other fuels to a gas that could be upgraded to hydrogen. The name Blauer Turm/Blue Tower comes from the architectural feature of the combination of the height and the blue exterior cladding of this tower, see Figure 69. In 2001, a 1 MW thermal (200kg/h) pilot plant was taken into operation in Herten, Germany, and was operated until 2006<sup>364</sup>. The inventors formed the company H2Herten GmbH in 2002 to develop the technology into a prototype stage and Blue Tower GmbH is responsible for the marketing of the Blue Tower technology. Already in 2002, a license agreement was signed<sup>365</sup> with Japan Blue Energy Co., Ltd. (fka Japan Planning Organization Co., Ltd.), who builds two plants in Japan, one at Izumo-shi, Shimane. The company appears to have further

<sup>359</sup> Europlasma. Communiqué de presse, le 22 mars 2018

<sup>360</sup> Europlasma. Document de référence 2010

<sup>361</sup> Le Turboplasma. Outil thermique efficace au service de la gazéification. Bioénergie sud. Nîmes 26-11-13

<sup>362</sup> Europlasma. Document de référence 2016

<sup>363</sup> www.concordblueenergy.com

<sup>364</sup> Blauer Turm in Herten. Antwort der Landesregierung auf die Kleine Anfrage 4501 vom 25. Februar 2016. Drucksache 16/11256. Landtag Nordrhein-Westfalen Drucksache 16/11662. 07.04.2016

<sup>365</sup> <http://jbec.jp/english/corporate/history/>

developed the technology and made parts of it proprietary, following up the previous experiences with new cooperation's<sup>366</sup> and a third plant.

In 2007, Blue Tower GmbH forms a JV<sup>363</sup> with the Rochem Group in India, resulting in that three plants are built in India from 2008 to 2012, see below.

To realize the German prototype project, an investor, Solar Millennium Group, became the main shareholder in H2Herten GmbH, and in 2009 the construction of a 13 MW thermal prototype at a cost of 39 million €, of which a 7 million € grant. This plant was not completed when Solar Millennium filed for bankruptcy in 2011. As a result, the project company H2Herten also had to go bankrupt in early 2012.

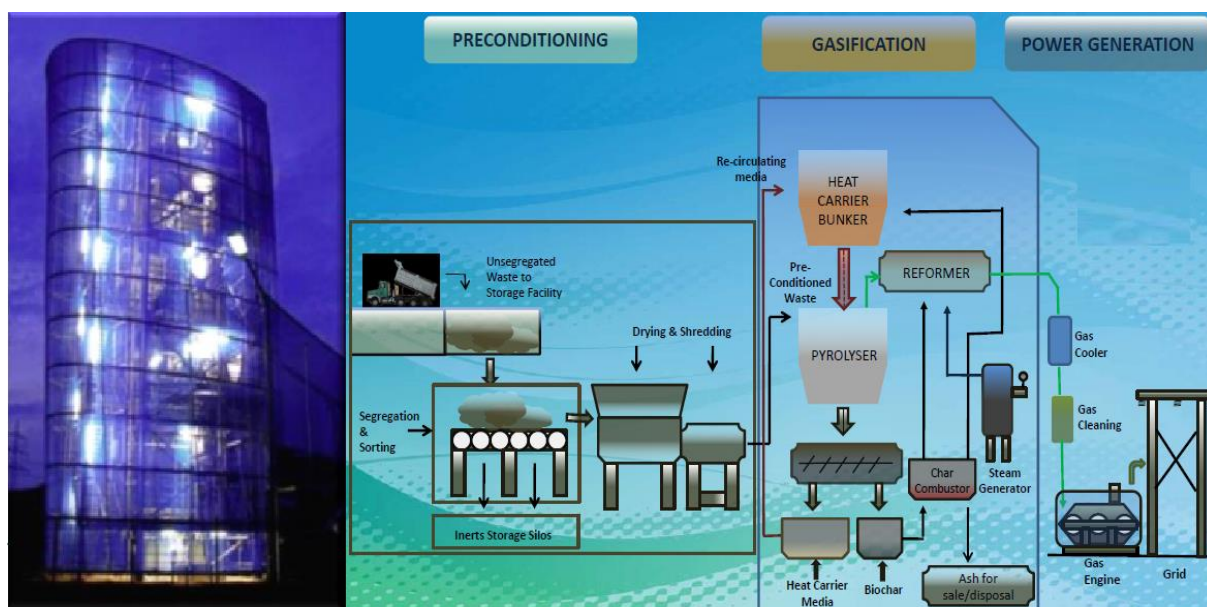

**Figure 69 The Blaue Turm in Herten and flowsheet for the Pune plant (Adapted from<sup>367</sup>)**

In parallel, the Concorde Blue company was formed in 2002 by a close friend to Dr. Mühlen and his son. In 2012, Concorde Blue had secured the rights to the Blauer Turm process<sup>368</sup>. Concorde Blue also engages in a project in Arizona and forms a strategic partnership with the US defence group Lockheed Martin in 2013 where the latter is the preferred integrator and EPC contractor for the Blauer Turm technology<sup>363</sup>, the first installation being a 250 kW plant<sup>369</sup> at the Lockheed Martin facilities in Owego, NY that opened in 2016. In February 2014, the Concord Blue group of companies also acquired the Herten prototype plant from the administrator. The intention is to complete the plant at a scale of 5 MW in collaboration with the US group Lockheed Martin as an EPC contractor<sup>370</sup>. Also, in 2016, it was announced<sup>371</sup> that Lockheed Martin would build a 10 MW<sub>e</sub> waste to energy plant in Wales for Cogen Ltd, a UK waste to energy plant developer, using the Blauer Turm technology.

The technology is designed for modules from 250 kW thermal up to 5 MW thermal. The processing,

<sup>366</sup> <http://www.greencarcongress.com/2012/09/bluetower-20120911.html>

<sup>367</sup> Concorde Blue – Thermal Based Waste to Energy Presentation. Environmentally Friendly W2E Solution Unsegregated MSW for Municipal Corporation. Rochem 2011.

<sup>368</sup> Käufer für Blue Tower GmbH gefunden. Der Westen. Medien NRW, 17.03.2012

<sup>369</sup> <http://www.biomassmagazine.com/articles/13719/lockheed-martin-opens-advanced-bioenergy-plant-in-new-york>. September 21, 2016

<sup>370</sup> <http://www.biomassmagazine.com/articles/13016/lockheed-martin-concord-blue-begin-next-phase-of-bioenergy-plant> March 16, 2016

<sup>371</sup> <http://www.cogenuk.com/featured/lockheed-martin-cogen-build-energy-waste-plant-wales/> 11 Oct. 2016

Figure 69, starts with preparation of the waste in a recycling plant where inerts and metals are recovered, and the waste is shredded and dried, using waste heat from the plant. The prepared waste is conveyed in enclosed conveyors to the gasification system and is fed to the first of thermolysis chambers. In the thermolysis chambers, the waste is contacted and mixed with hot alumina heat carrier beads such that the waste is pyrolyzed up to 400 °C in the second chamber and 600 °C in the first chamber. At the bottom the heating beads is separated from the char and ash.

The char residue from the pyrolyser can be separated as a bio-char if clean biomass is used, in which case a part of the product gas is used, or it can be combusted with less fraction of product gas to generate heat for the reheat of the heat carriers. The hot combustion gases are routed to the heat carrier bunker and the reformer as direct and indirect heating medium.

The heat carrier beads are transported by an elevator conveyor to the heat carrier bunker. In the heat carrier bunker, the heat carriers are reheated to 1 000 °C or higher. The heat carrier, after being reheated, is then returned by gravity to the pyrolyser via a lock system (in previous, older descriptions, the hot heat carriers are first used inside the reformer and then transferred by gravity to the pyrolyser located directly beneath the reformer).

The product gas is, together with steam, fed to the reformer where the gas mixture is heated to 950 °C, whereby the tars are reformed, and the water gas shift is performed. The product gas is then cooled and is further cleaned by scrubbing with no further details given. The gas analysis varies with the feed and operating conditions, and no consistent data have been found in open literature. It is noted that the hydrogen content is high. Power is generated in a gas engine which can be fitted with oxidation and SCR catalysts as required.

The status of Blauer Turm plants is somewhat difficult to find but Table 32 contains a list of plants and projects. It has not been possible to find much data on these plants. The Pune plant was expected to use 13.5 tonnes/h of prepared RDF with an energy content of 10 MJ/ton, or 38 MW thermal to produce 11 MW<sub>e</sub> gross and export 10 MW<sub>e</sub><sup>372</sup>. This gives a net efficiency of 26 %. The Pune plant has not been completed and there are questions on the operation of the plant<sup>372</sup>. The author of an article<sup>373</sup> from 2014 related to the Eagar plant development in Arizona tried to find out more background information on these plants and was not impressed with the results; some of the plants in India and Japan were no longer in operation due to technical issues, and the authorities in Herten had little information on any re-start of the Herten plant. The plans were to obtain permits in 2015 to start construction in 2016, but according to the local authorities<sup>364</sup>, no activity had been noted at least up to 2016.

Neither the Soperton nor the Cardiff plant are included in the project list on the Concorde Blue web page<sup>363</sup>. A UK lobby organisation that closely follows activities on waste incineration plants in the UK notes that there has been no additional information or official activity regarding the Cardiff press release in 2016<sup>374</sup>.

---

<sup>372</sup> Waste-to-power plant turns into dumping yard. Vijay Chavan, Pune Mirror, Aug 4, 2017

<sup>373</sup> Lost in the woods. How the Forest Service is botching its biggest restoration project.

Claudine LoMonaco. High Country News, Sept. 1, 2014

<sup>374</sup> <http://ukwin.org.uk/resources/table/#Region11>

**Table 32 Blauer Turm plants and projects**<sup>363, 364, 365, 367, 375</sup>

Plant location	Year	Capacity	Feed	Comments
Herten, DE	2001–2006	1 MW	Various	Dismantled
Anun-Shi, tokushima JP	2004-			
Izumo-shi, Shimane, JP	2006-2010		Biomass Sludge	
Herten, DE	2009–2012 2014	13 MW 5 MW	Biomass	Never completed Construction announced but not started yet
Vasai, Mumbai IN	2009	30 kW <sub>e</sub>	RDF	
Mahad, IN	2011	3 MW	RDF	Fuel gas for steam generation
Sikar, IN	?	1 MW <sub>e</sub>	RDF	
Pune, IN	2012-	~3 MW <sub>e</sub> ~2*3 MW <sub>e</sub>	RDF	Expansion to total 10 MW <sub>e</sub> net planned but not
Omuta, Fukooka, JP <i>aka</i> Shibukawa-shi, Gunma	2013	7 200 Nm <sup>3</sup> /h H <sub>2</sub>	Biomass	In operation
Owego, NY, USA	2016	0.25 MW	Biomass	In operation
Soperton, GA, USA			Biomass	Lanzatech ethanol by gas fermentation
Abuja, NI		3 MW <sub>e</sub>	RDF	
Eagar, AZ, USA		1 MW	Biomass	
Cardiff, UK		10 MW <sub>e</sub>	RDF	
Chennai, IN		15 MW <sub>e</sub>	RDF	

#### 7.3.2.4. Lahti II (Kymijärvi II)<sup>376</sup>

As was described in Section 7.2.2, the initial plan was to use gasification of solid wastes as a means reduce the coal firing in the Lahti I coal fired boiler, see Section 7.2.2,. To avoid negative impacts on the boiler, such as corrosion and fouling, gas cleaning for the gasifier was also planned. The cleaning would proceed by injection of sorbents, cooling of the gas to a temperature where tars would be maintained in the vapor phase and the subsequent removal of solids in a hot gas filter, whereby alkalis and chloride would be removed as solids before the combustion. However, other contaminants such as sulphur, NO<sub>x</sub> precursors and Hg were not subject to cleaning measures before combustion of the gas.

This gas cleaning concept, i.e. to absorb chlorides and condense alkalis by cooling the gas and then remove particulates at 300-400 °C in a filter, in combination with co-firing into an existing boiler was not new. As early as before the year 2000, SHI FW (*fka* AMEC Foster Wheeler, Foster Wheeler Finland and Ahlström Pyropower), the supplier of the Lahti I gasifier and the Danish utility DONG (*fka* Energi E2 or Elkraft) had studied the same concept but applied to straw, which also holds a significant content of chloride and alkalis, to possibly be used for a co-firing application for a coal-fired boiler in Denmark. This development was partially conducted as a FP5 project<sup>377</sup>, involving tests of straw gasification and gas cleaning at a pilot installation in Karhula and a process design

<sup>375</sup> Concord Blue and Lanzatech to Produce Fuels from Waste Biomass Resources in Georgia. Press release Dec. 4, 2013

<sup>376</sup> www.lahtigasification.com

<sup>377</sup> Straw Gasification for Co-Combustion in Large CHP-Plants. Acronym: Strawgas. Contract No: ERK5 – CT – 1999 – 0004. Project No: 1999/C77/13 AND 1999/C77/15. ENERGI E2. 31. MAY 2001



and case study for Amager 3 and Avedöre 1 power/CHP plants in Copenhagen. The conclusions were that the concept had been validated and that the co-combustion at 100 MW<sub>th</sub> gasifier capacity was technically feasible, whereas the economic feasibility was marginal under the prevailing conditions in Denmark at the time.

Nevertheless, SHI FW and partners pursued the development of the concept by e.g. doing slip-stream tests with a gas cooler and a filter at the Lahti I plant for over 3 300 hours in 2003-2004<sup>378</sup> and by considering methods for cost reduction and re-use of gasifier ashes in the FP5 project GASASH<sup>379</sup>. In addition, a FP6 demonstration project, Lahtistreams<sup>380,381</sup>, was also initiated in 2006 to develop the technology for gas cleaning and also to provide some co-financing for the realization of the plant.

The project for the Lahti II or Kymijärvi II plant was initiated in 2005 as it became gradually clear that the interpretation of the WID, see Section 7.2.2, would no longer allow the use of waste in the Kymijärvi I gasifier as the gasifier and coal boiler ensemble would be seen as a co-incinerator. The consequence was that the old coal plant would have required investments in flue gas cleaning to meet the co-incinerator limiting emission values that would not otherwise be required under the LCP directive. Furthermore, it was seen as a risk that since the plant would be defined as a co-incinerator, the EU-ETS emission rights would be costly, whereas if a stand-alone waste incinerator was built, it would not be part of the ETS system. Therefore, there was a decision to prioritize the stand-alone design rather than a co-firing installation using the existing coal boiler. An environmental permit for the Lahti II plant was obtained in 2007, and the building permit in 2009. However, partially due to the lengthy permitting process for Lahti I and partially due to that SHI FW prioritized biofuels gasification activities in 2007, the company decided to not pursue the Lahti II project<sup>381</sup>. Instead Lahti Energia contacted Valmet (*aka* Mesto Power) in 2008 to explore the interest. Valmet had a gasifier background from Götaverken and Tampella Power and was considering the technology, e.g. by conduction slipstream filter test in a lime kiln gasifier at Värö, Sweden, originally supplied by Götaverken<sup>382</sup>.

Eventually, the discussions with Valmet led to a contract to build the Kymijärvi II plant at the end of 2009. In parallel to the technical development, Lahti Energia had been active in securing financing for the plant. The total project cost was 160 million €, of which the European Union contributed 7 million € as part of the Lahtistream project, and the Ministry of Employment and the Economy (TEKES) contributed 15 million € as development support in the form of grants. In addition, Lahti Energia took loans from the European Investment Bank (EIB), 70 million € and the Nordic Investment Bank (NIB) 50 million €<sup>383, 384, 385</sup>. The plant was constructed in two years and was ready for operation in 2012.

The plant is composed of the fuel storage and feeding section and two parallel lines of gasification, gas cooling and gas cleaning, before the produced gas from both lines is fired into a common boiler

---

<sup>378</sup> Foster Wheeler biomass gasifier experiences from Lahti & Ruiien and further cases for difficult biomass & RDF gasification. Timo Anttikoski, Juha Palonen, Timo Eriksson. IEA Bioenergy ExCo55 Workshop: Co-utilisation of Biomass. Copenhagen, Denmark on 25-26 May 2005

<sup>379</sup> Improvement of the economics of biomass/waste gasification by higher carbon conversion and advanced ash management. Final Technical Report. GASASH ENK5-CT-2002-00635, PROJECT N°: NNE5-2001-00598. VTT, Finland. 2005

<sup>380</sup> D51 Proceedings of the first internal workshop on Waste Management and WtE Technologies. LAHTISTREAMS, TREN/S07.54003/518338. M. Nieminen, VTT, Finland. 22.8.2007

<sup>381</sup> D54 Proceedings of the Advanced WtE Technologies -seminar. LAHTISTREAMS, TREN/S07.54003/518338. M. Nieminen, VTT, Finland. 20.6.2012

<sup>382</sup> Development and experience of Biomass Gasification in Metso Power. Pekka Saarivirta. SGC International seminar on Gasification, 9-10 October 2008, Malmö, Sweden

<sup>383</sup> <https://www.decentralized-energy.com/articles/print/volume-13/issue-3/features/finns-pioneer-waste-to-biogas-chp-district-heating-technology.html>

<sup>384</sup> [www.eib.org/infocentre/press/releases/all/2010/2010-141-finlande-la-bei-soutient-un-projet-innovant-de-valorisation-energetique-des-dechets-a-lahti.htm](http://www.eib.org/infocentre/press/releases/all/2010/2010-141-finlande-la-bei-soutient-un-projet-innovant-de-valorisation-energetique-des-dechets-a-lahti.htm)

<sup>385</sup> [ww.nib.int/news\\_publications/cases\\_and\\_feature\\_stories/209/cleaner\\_waste-to-energy\\_in\\_finnish\\_lahti](http://ww.nib.int/news_publications/cases_and_feature_stories/209/cleaner_waste-to-energy_in_finnish_lahti)

fitted with flue gas cleaning to meet WID/IED requirements<sup>376</sup>. The steam produced is sent to a turbine to generate power and heat for the city is extracted from the turbine condenser, see Figure 70 and Figure 71. The main technical data of the plant are:

- Total waste processed: 250 000 tonnes per year.
- Gasifier thermal input: 2·80 MW SRF and other fuels
- Boiler steam conditions: 120 bar, 540 °C.
- Nominal CHP output: 50 MW<sub>e</sub>, 90 MW<sub>th</sub>
- Annual production: 280-300 GWh of electricity and 680-700 GWh of heat.
- Efficiency to power and total efficiency: 31 % and 88 % respectively.

Compared to the conventional waste incinerator at pressures of 40-70 bars and superheat temperatures of 420-500 °C that are limited by mainly chloride corrosion and allowing 20-25 % efficiency, see Section 6.3, the higher steam conditions are feasible because the gas cleaning removes both particulates and alkali and chlorides that cause corrosion and fouling. This leads to this significant increase in the efficiency and if the plant had been designed for power production only and had adopted a re-heat steam cycle, it is estimated that an efficiency as high as 35 % could have been reached. But, in this case as for any fluidized application of waste, the potential for higher efficiency and other benefits of fluidized beds are offset by the need for a higher level of fuel pre-treatment than for a grate-fired incinerator, which has cost implications.

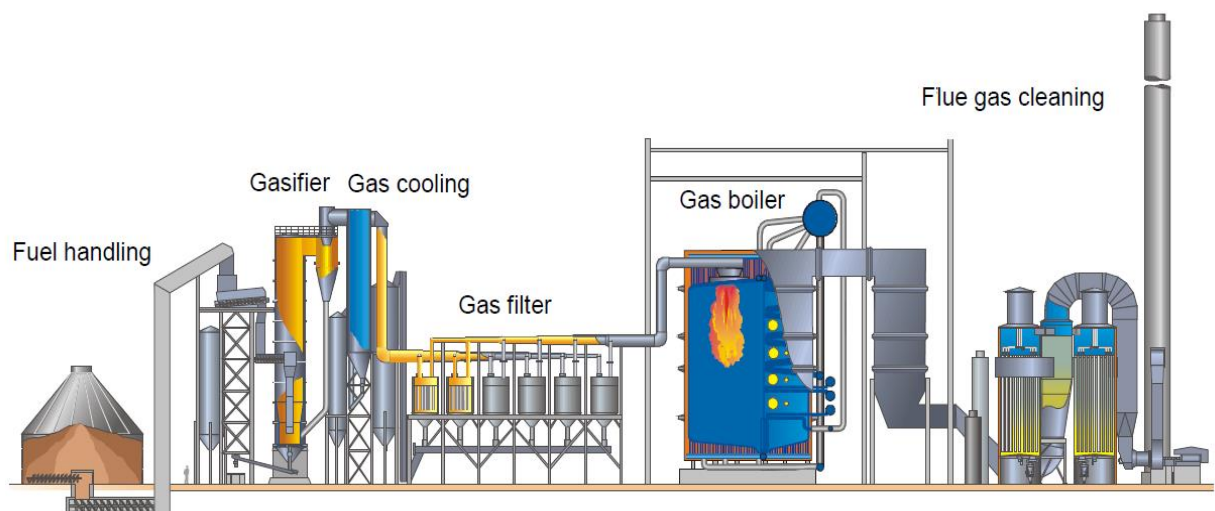

**Figure 70** Kymijärvi II plant, schematic flowsheet of the fuel/gas path (Adapted from<sup>386</sup>)

The plant is fed with SRF, a quality-secured form of RDF, and recycle waste wood. The preparation of the fuels is made off-site by waste management and recycling companies in southern Finland. This include shredding to 20- 40 mm and mechanical treatment to remove unsuitable fractions such as inert, bio-waste, glass and metals. The SRF fuel is typically around 20 % from source-separated household waste from the region and construction and demolition waste. The fuel is typically within the following ranges: moisture 15-25 wt.%, ash 10 wt.% on a dry basis, LHV 13-20 MJ/kg as fired<sup>376</sup>. The fuel is transported by truck from the waste treatment installations to the plant and fed into the fuel storage silos.

The fuel is discharged from the large fuel silos by means of screw feeders at the bottom of the silos to a central discharge into the screw feeder below which brings the fuel to the apron conveyor. This

<sup>386</sup> Commercial CFB Gasification of waste and biofuels - Operational experiences on a large scale. Juhani Isaksson. 2015 Gasification Technologies Conference, 11-14 October 2015, Colorado Springs, USA.

240-metre long conveyor takes the fuel as a bed of a defined height from the feeder and transports it to the gasifier structure. At the other end of the conveyor there is a 200 m<sup>3</sup> silo. Fuel is fed from the silo to the gasification reactor via two Feedmaster dosing and seal system per line, Figure 72. Bed material and additives such as lime are also fed to the horizontal conveyor upstream of the seal system.

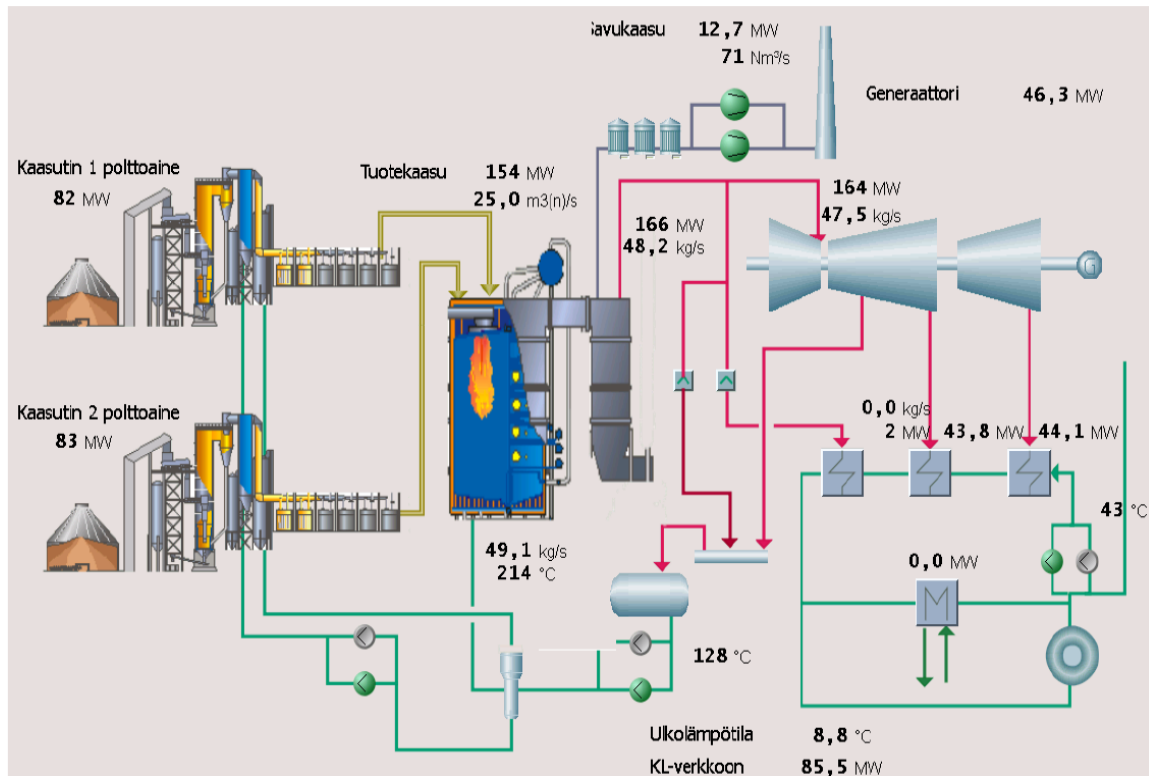

**Figure 71 Kymijärvi II, schematic plant flowsheet incl. steam and power sections<sup>387</sup>**

Kymijärvi II has two parallel atmospheric pressure circulating fluidised bed (CFB) gasifiers, each 5 m in outer diameter and 25 m height. Each gasifier has a bed of sand and lime particles which heats the fuel arriving in the reactor and acts as a heat accumulator stabilizing operation. The fluidized bed is blown with sub-stoichiometric amounts of air injected via distributor at the bottom which reacts with the fuel at 850-900 °C. The main components of the product gas are carbon monoxide, methane, hydrogen, carbon dioxide, steam, and nitrogen originating from the gasifying air. The gasifiers are started up with natural gas. The gas is separated from solids in the outlet cyclone where the sand, lime and ash are recovered and recycled to the gasifier bed, while the gas flows to the gas cooler. Ash, low in carbon and inert, is extracted from the gasifier bottom and was originally disposed of in a landfill. This system has now been improved by bed material recirculation and also allowing bottom ash to be used as a construction material.

The product gas is then cooled from 900 °C to about 400 °C. The heat recovered is used in a pressurised watercooling loop that in its turn preheats the boiler feed water going to the boiler. The gas cooling is a multi-pass proprietary design with membrane panels in the hot pass, Figure 73.

As an effect of the cooling to 400 °C, the temperature is low enough for contaminants causing corrosion, such as alkalis and chlorides, to condense on the ash particles in the gas or to react with lime, respectively, and can then be separated out in the downstream filter, the temperature is still

<sup>387</sup> State of art fluid bed gasifiers and boilers for biomass and wastes. Juhani Isaksson. IEA Bioenergy / Task 33 IEA Fluidized bed conversion of biomass and waste workshop. Skive, Denmark. October 24th, 2017

high enough to maintain the tars in the gas in the vapour phase and such that they do not interfere with the filter operation.

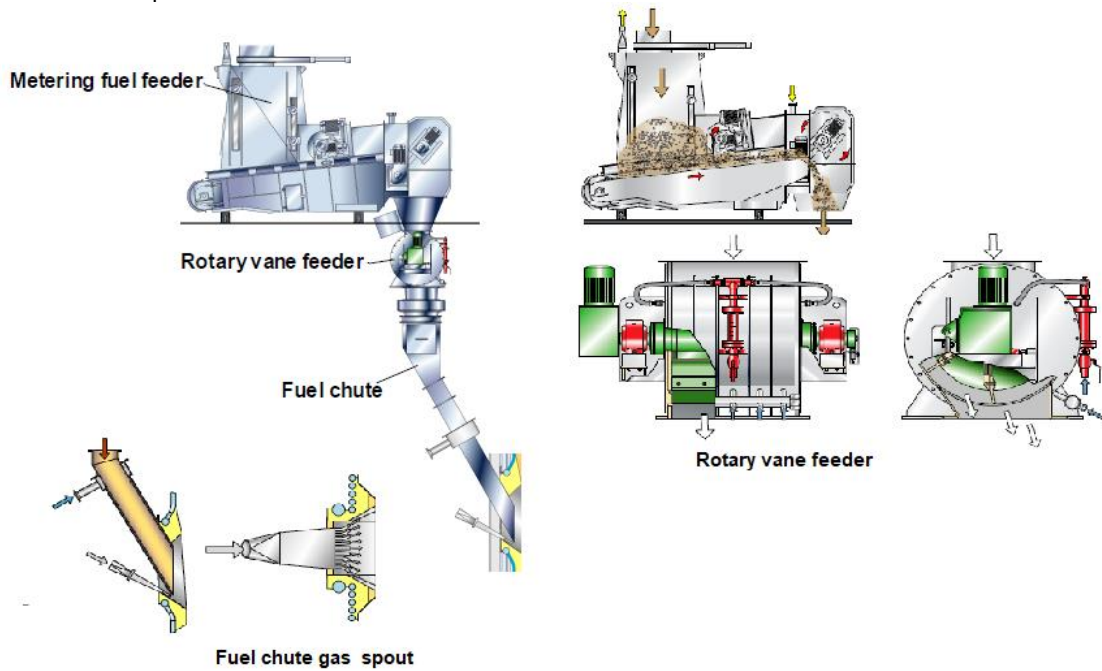

**Figure 72 The FeedMaster feed system<sup>388</sup>**



**Figure 73 A photo of the gas cooler in the Kymijärvi II plant<sup>389</sup>**

After cooling, the product gas is cleaned from particulates, including the condensed alkalis and chloride absorbed by lime, by hot gas filtration, Figure 74. Each of the two gasification lines has 6 filter vessels that each holds 300 candle filter elements. The candles are made of porous ceramic fibres and are closed in one end located on the dirty side of the filter, and open in the other, outlet end on the clean side above the tube sheet. The candles are 0.2 m in diameter, 2.5 m long and weigh 10 kg each. The gas coming from the gas coolers passes through the porous filter elements

<sup>388</sup> Feeding Systems for Demanding Fuels. FeedMaster. Brochure. Valmet Corporation, HPG\_B\_R\_2300\_093-02 1609. and Gasification as pretreatment of solid fuel for combustion in PC and gas fired boilers. Metso November 2, 2010 February 8, 2010

<sup>389</sup> Metso Waste Gasification. Juhani Isaksson. Valtakunnalliset jätteen hyötykäyttöpäivät. 19.11.2013 Lappeenranta

and the particles form a filter cake on the exterior surface of the candles while the gas on the inside flows axially to the clean side.

When the thickness of the filter cake generates a pressure drop that exceeds a certain limit, a section of the filter is cleaned by a pressurized nitrogen pulse from the clean side that momentarily reverses the flow and breaks up and detaches the filter cake which fall into the bottom cone of the filter, from where it is removed into the ash system. The fly ash particle size is small, it has a high carbon content and also contains inorganic contaminants and adsorbed tar species. This material is sent for post-processing to an external contractor.

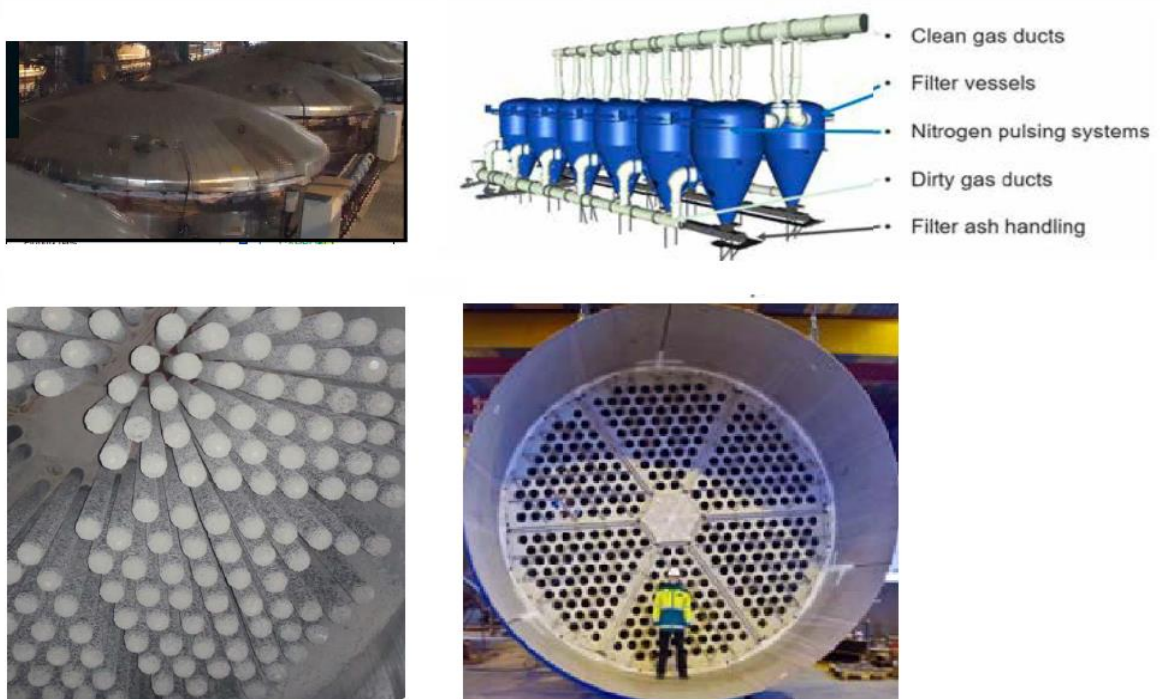

**Figure 74 Hot gas filters in the Kymijärvi II plant. Vessel tops, overall arrangement, candles from the dirty side, the tube sheet. (Adapted from<sup>381, 390, 391</sup>)**

The gas is burned in four burners (two per line of gasification), that fire downwards from the ceiling of the boiler. The burners are designed for a capacity of 40 MW thermal each for both low calorific gas and natural gas and were supplied with natural gas armatures and cooling air fans<sup>392</sup>. The design range in heating value of the gasification gas is 4.6-5.8 MJ/Nm<sup>3</sup> and maximum gasification gas flow per burner 25000 Nm<sup>3</sup>/h. The burners are ignited with natural gas and once ignited, switches to the gasifier product gas, which is used as the primary fuel of the boiler. A nominal total of 24 m<sup>3</sup>/s of gas is fed to the burners during operation<sup>376</sup>. The principles of the dual fuel natural gas and LCV gas burner is shown in Figure 75. If the burners are not available for operation, there is also a flare stack to which gas can be routed temporarily.

<sup>390</sup> Large Scale CFB Gasification of Waste and Biomass. Joonas Kaasalainen, Melina Kallio-Könnö, Juhani Isaksson. 12th International Conference on Fluidized Bed Technology

<sup>391</sup> Progress in commercial scale CFB gasification for waste and biomass. Juhani Isaksson. IEA Task 33, Univ. of Sevilla joint Symposium on Renewable Energy and Products from Biomass and Waste. CIUDEN (Cubillos de Sil, León, Spain), 12-13 May 2015

<sup>392</sup> <https://www.saacke.com/za/news-references/references/gasification-plant-lahti/>

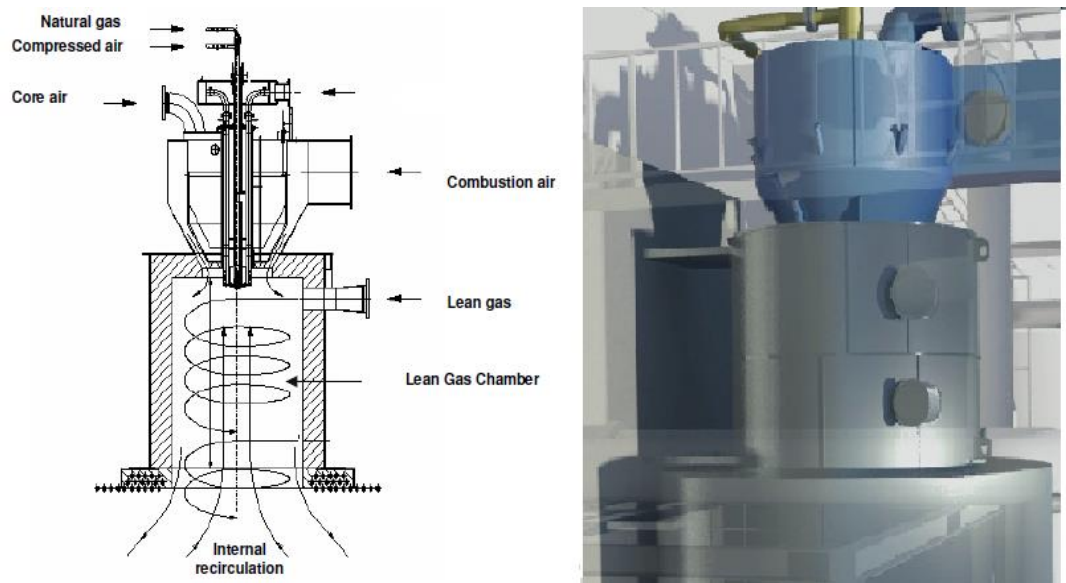

**Figure 75 Schematic and principal design of a natural gas/ low calorific value gas burner as used in Kymijärvi II<sup>393</sup>**

The boiler is a natural-circulation steam boiler with a water tube structure, producing superheated steam at 12.1 MPa and 540 °C. Burning of clean gas produces a temperature of at least 850 °C. Since the boiler is designed for a gaseous fuel without solids present, it can be designed more compactly due to the higher flame intensity and that less tube-to-tube spacing can be used than it would for a solid fired incinerator, which saves on the cost for the boiler. The superheated steam is fed to a tandem extraction/backpressure steam turbine with a 60 MVA generator with a nominal output of 50 MW<sub>e</sub>. Extraction and backpressure steam heats the district heating water in the hot and cold condenser, respectively. 90 MW of heat can be transferred to the district heating grid. There is also a turbine by-pass to the hot condenser.

Since the plant only has partial pre-combustion gas cleaning, the flue gases emerging from the boiler need additional treatment to meet the EID waste incinerator limiting emission levels. To reduce NO<sub>x</sub> an SCR system is used, after which additives (sodium bicarbonate and activated carbon) are injected into the gas to remove sulphur and other acid gases as well as heavy metals and dioxins/furan. Finally, a bag filter removes particulates present, including the spent additives.

The plant was commissioned in the beginning of 2012 and has since the second half of 2012 been in commercial operation<sup>394</sup>. Up to and including 2016, the plant has been in operation for more than 30 000 hours, see Table 33. However, the estimated nominal annual production of 280-300 GWh of electricity and 680-700 GWh of heat has not been reached in any year. However, the plant is operated on a commercial basis without any subsidies for either electricity or heat. This means that the balance between power and heat over the year can follow the demand and value of each product. What is noticeable is that the waste wood fraction in the fuel has increased over the years from ¼ in 2013 and in 2016 was roughly 2/3 of the total fuel. This has been done partially to optimize the availability but also to reduce the operating costs, as less quantities of secondary wastes are produced<sup>395</sup>. The data for 2017 are more or less similar to the 2016 figures<sup>396</sup>.

<sup>393</sup> Functional Principle of SSB Swirl burner with LCG Throat. Saacke GmbH, and Thermal Use of Low Calorific Gases in Chemical Industry. Norbert Schop. CHEMA 2009, Frankfurt, Germany

<sup>394</sup> Valmet CFB gasifier. Juhani Isaksson. IEA Bioenergy Task 33. Workshop on Waste Gasification. ECN, Petten, The Netherlands, 08.05.2018

<sup>395</sup> <https://blogit.lassila-tikanoja.fi/lassikko/lahti-energia-optimises-the-quality-of-solid-recovered-fuel>

**Table 33 Operational data for Kymijärvi II 2012-2016<sup>396</sup>**

Year	Operational hours	RDF	Waste wood	Electricity	District Heat	Bottom Ash	Filter Ash	Bag House Ash
	h	t	t	GWh	GWh	t	t	t
2012*	4267	141 593	0	141	366	10 538	9 859	1 784
2013	5353	141 253	42 792	188	422	12 826	12 465	2 461
2014	6967	119 251	129 805	241	514	16 834	17 292	2 376
2015	6690	99 032	141 058	180	554	14 856	15 792	1 539
2016	6772	84 569	158 347	172	548	11 037	16 260	1 986

The fuel feeding is reported to in principle have worked well. However, the fuel supplied occasionally also includes tramp/metals/oversize particles that cause wear and blockages, etc. and some improvements have also been made to the rotary feeders. Experience-based improvements have also been undertaken such as adding additional service openings and improving working methods.



**Figure 76 The Kymijärvi II plant at night. Conveyors to the gasifier building, the coal plant at its roof- located stack at the rear<sup>397</sup>.**

The composition of the fuel compared to the design fuel is shown in Table 34. Despite the variability, which can be in the short-term higher than indicated for the monthly samples, the plant has been to reach its design capacity and support fuel has not been required even when the fuel moisture content has reached 40 %.

<sup>396</sup> Personal communication, J. Isaksson, Valmet.

<sup>397</sup> Courtesy of Valmet Power

**Table 34 Fuel composition, monthly combined samples, for Kymijärvi II 2012-2016<sup>396</sup>**

	LHV, ar	Moisture	Ash	C	S	Cl	Na+K	Hg
	MJ/kg	%	%, in dm	%, in dm	%, in dm	% in dm	% in dm	mg/kg in dm
Predicted design data	16,1	21,0	7,6	55,5	0,15	0,60	0,20	<0,1
Experienced average	14,1	26,6	8,5	50,1	0,3	0,33	0,15	0,1
Experienced min	10,8	19,0	5,2	44,4	0,2	0,11	0,09	0,05
Experienced max	17,5	37,5	14,8	57,0	0,6	1,8	0,35	0,3

The gas cooling has worked as planned and this far no corrosion has been observed. There have been some mechanical problems with soot blowing equipment.

The gas filter was a main source of unavailability in the first year. This is not entirely surprising as this is one of the key novel features of this plant and there is little experience for this type of filter for similar service at this scale, while also being a key component differentiating this technology from two-stage incinerator-gasifiers. Premature filter failures were common in the beginning<sup>398</sup>. This was caused by carbon-containing ash that was retained in and on the filter over time, despite of the pulse cleaning, which during start-ups and shut-downs was oxidized and caused local overheating of the filter element. This has been addressed by changes in the operational procedures and as part of the regular maintenance since 2013 to also have periodic off-line cleaning of the filters. The filter element lifetime is said to now be 3-4 years, or more.

The gas burners have required some small adjustment of the flame detection system but have otherwise performed well. There has been no evidence of corrosion in the boiler showing that the concept works. With regard to emissions the plant has fulfilled the IED requirements, Table 34.

The plant is complex and has to operate in a stable way towards the electric and district heating grid using a fuel with high variability. This requires an extensive automation system that supervises the plant from the front-end fuel reception to the back-ends grid connections and the stack. There are almost a thousand metering points and about 200 controlled motors and actuators. Of the total investment of 160 million €, the EIC system costed almost 10 million €<sup>381</sup>. The complexity of this system and the way it was set-up was initially a major contributor to unavailability. However, the experience and learning have resulted in the operating routines and control procedures having been modified such that the complexity of the process and its control is now manageable.

As was noted earlier in Section 7.2.2, the next plant to come into operation at Lahti is Kymijärvi III, which is a woody biomass fired heat only CFB of 160 MW thermal input and which can optionally be converted to a CHP plant. This plant will replace the Kymijärvi I coal fired boiler and the associated co-firing gasifier in 2019.

The Lahti plant has shown, despite of being quite successful in proving the concept, that a high efficiency can be obtained, that corrosion in the main boiler is negligible despite of the elevated steam conditions, that emissions can be controlled within the regulatory limits and at relatively low cost.

<sup>398</sup> High efficiency electricity production from SRF/REF through gasification. Vesa Helanti. Energiforsk International Seminar on Gasification, 19-20.10.2016, Malmö Sweden.



**Table 35 Kymijärvi II emissions record, 2013-2016<sup>396</sup>**

Emission	Limit 0,5h average and unit	2016	2015	2014	2013
NO <sub>x</sub>	400 mg/Nm <sup>3</sup>	211	217	184	152
SO <sub>2</sub>	200 mg/Nm <sup>3</sup>	40	55	43	32
CO	100 mg/Nm <sup>3</sup>	4	1	1	1
Dust	30 mg/Nm <sup>3</sup>	< 1*	< 1*	< 1*	1
HCl	60 mg/Nm <sup>3</sup>	3	7	2	8
HF	4 mg/Nm <sup>3</sup>	< 0,2*	< 0,8*	< 0,2*	< 1
TOC	20 mg/Nm <sup>3</sup>	< 1*	< 1*	1	1
PCDD/F Compounds	0,1 ng/Nm <sup>3</sup>	0,0004	0,001	0,0004	0,001
Hg	50 µg/Nm <sup>3</sup>	< 0,7*	< 1,2*	0,1	< 0,02*
Cd+Tl	50 µg/Nm <sup>3</sup>	< 0,2*	0,01	< 0,01*	< 0,7*
Sb+As+Co+Cr+Cu+Mn+Ni+Pb+V	500 µg/Nm <sup>3</sup>	7,6	2,0	1,5	0,3*

\* Means the measured value is below analysis detection limit  
From annual AST/QAL2 measurements

Despite the promising results, this reference installation has not led to any similar plants elsewhere although operation has been on-going for five years. However, there has been an interest in e.g. the UK for this technology. The company Bioessence Ltd was developing two projects, 25 MW<sub>e</sub> in the London area and 50 MW<sub>e</sub> in the Liverpool area, respectively, based on the Valmet technology. The ELSEF project in London in particular was far advanced in that it had planning permission 2011 and OFGEM approval to receive 2 ROCs/MWh<sup>381</sup>. However, the company could not reach financial closure on the project and has since ceased operation.

### 7.3.2.5. Plasco, Ottawa, Canada<sup>399</sup>

The development of the Plasco waste gasification process began<sup>400</sup> in 1974 in Canada, when the predecessor Resorption Canada Ltd., Plasco Plasma and partners started to develop plasma treatment for hazardous waste and in the 1980s also plasma gasification of waste. The plasma torch technology was provided by the Phoenix Solutions Co<sup>401</sup>. For this purpose, a 5 tonnes/day pilot plant was constructed in Canada. In the late 1990s, RCL started to cooperate with the Spanish waste management company Hera Grupo, and a joint venture was formed in 2003<sup>402</sup>. As a result, the pilot plant was relocated to Castellgalí, Spain in the same year. The upgraded pilot plant was used as a technology validation unit for the Plasco process and by 2006 a basis of design for a larger facility was obtained. To market the technology, Plasco Energy Group was founded in 2005 after a consolidation of RCL and its majority-owned sister company, Plasco Energy Corporation.

After reaching an agreement with Ottawa city council in 2005<sup>403</sup>, Plasco constructed a pilot facility at the City of Ottawa's Trail Road landfill site at a cost of 60 million \$CA<sup>404</sup>. The pilot facility was

<sup>399</sup> <http://plascotechnologies.com>

<sup>400</sup> Plasco Energy Group's advanced technologies turn waste into an opportunity. Chris Terajewicz. The New Economy. December 18th, 2014. [www.theneweconomy.com/technology/plasco-energy-groups-advanced-technologies-turn-waste-into-an-opportunity](http://www.theneweconomy.com/technology/plasco-energy-groups-advanced-technologies-turn-waste-into-an-opportunity)

<sup>401</sup> <http://www.phoenixsolutionsco.com/energyproduction.html>

<sup>402</sup> [www.zerowasteottawa.com](http://www.zerowasteottawa.com) Waste management World, 2006-11-01

<sup>403</sup> SUBJECT: Plasco Long-term Waste PROCESSING Agreements Report to Ottawa Environment Committee and Council, 5 December 2011 Ref N°: ACS2011-ICS-ESD-0039

<sup>404</sup> Clean. Economical. Practical. Rod Bryden. Plasco Presentation, undated.

designed to process 85 tonnes per day of MSW to produce 4 MW<sub>e</sub> via six 1 MW nominal GE Jenbacher engines, derated to 0.75 MW<sub>e</sub> for use with the gas produced. The plant was commissioned in 2007 and was ready for operation in 2008. The plant was permitted for campaign operation until the beginning of 2011<sup>405</sup>. From 2008, when operation was initiated, and the permit changed to continuous demonstration, subject to meeting defined emission requirements, and up to 2011, the process was validated. In 2011, the permit for continued operation was granted and the technology was modified into an Integrated Conversion and Refining System (ICARS) and the plant capacity was expanded to 135 tonnes/day. In parallel to the pilot plant, Plasco and the city of Ottawa in 2012 agreed to pursue a commercial plant project<sup>406</sup>, with three state-of-the art ICARS lines to process approximately 300 tonnes/day or 110 000 tonnes/year of MSW to electricity. Plasco would build, own and operate the plant, and the city would pay a gate fee of 83 \$CA per tonne, or approximately 9 million \$CA annually, for a period of 20 years. The plant was expected to start operation in 2016, but on the condition that the financing to initiate constructions should have been secured by Plasco in 2013.

From 2012 to January 2015 the modified ICARS plant was operated, but by then economic conditions had deteriorated<sup>407</sup>. However, other sources also infer limited availability as a cause of economic problems<sup>295, 408, 409,, 410, 411, 412</sup>. Furthermore, Plasco met with difficulties in the financing of the scaled-up commercial plant, the financing milestone date was moved twice, management rearrangements occurred in 2014 and finally Plasco had to declare itself insolvent<sup>413</sup> in 2015. This led to that the pilot ICARS plant was dismantled. The insolvency also caused the city to cancel the 20-year contract for waste deliveries. Following this, one director of old who was forced to step down in 2014 took over the company and the IPR from the liquidator in 2015 as Plasco Conversion Technologies and maintains it a going concern<sup>414</sup>.

The process lay-out is shown in Figure 77. Waste-carrying trucks are directed to the enclosed MSW receiving area of the Plasco plant, where the MSW was deposited<sup>399, 415, 416</sup>. From a feed hopper, MSW is loaded into a pre-shredder to provide initial sizing of raw MSW to between 125-200 mm. Once shredded, the material passes an electromagnetic ferrous separation unit and a vibrating screen-type classifier that separates the material into below 50 mm and above 50 mm fractions, respectively. The fine fraction passes an eddy current metal separator before being routed to the shredded material storage. The coarser fraction also passes an eddy current separator, before being re-shredded and again classified, with the accepted fraction being sent to the storage and the oversize material being recycled once more.

The shredded material is fed into the converter or conversion chamber at negative pressure by dual feeder airlocks that deliver the shredded waste while compressing the waste seals against air entering the converter. The material is fed to the inlet of a proprietary designed horizontal moving grate to which preheated sub-stoichiometric air at 300 °C is delivered to each grate section in a controlled flow with flow controlled based on the syngas analysis, see Figure 78.

<sup>405</sup> <http://www.wastetodaymagazine.com/article/rew0912-plasco-energy-sustainability/>

<sup>406</sup> <http://www.cbc.ca/news/canada/ottawa/plasco-and-city-ink-garbage-to-energy-deal-1.1144505>

<sup>407</sup> An Evaluation of Waste-to-energy Options for Monongalia County, West Virginia. E. Hansen et al. Downstream Strategies, Morgantown, WV 26505. August 29, 2016.

<sup>408</sup> Technical, environmental and economic assessment of Plasco Energy Group gasification process using plasma torches. Abstract. André KUNEGEL, ADEME, France, October 2009

<sup>409</sup> Plasco's Ottawa plan wasn't yet 'economically viable'. Vito Pilioci, Ottawa Citizen, February 12, 2015

<sup>410</sup> <http://www.cbc.ca/news/canada/ottawa/garbage-processed-by-plasco-overstated-city-manager-says-1.1248291>

<sup>411</sup> Plasco offers lesson in sobering reality J Chianello. Ottawa Citizen February 12, 2015 T

<sup>412</sup> Advanced Technology: Disparities Between Vision and Reality. Peter Chromec. HZI Client Event, Nottwil, 4 March 2016

<sup>413</sup> <http://www.cbc.ca/news/canada/ottawa/plasco-obtains-creditor-protection-80-jobs-terminated-1.2951751>

<sup>414</sup> Rod Bryden buys back Plasco from creditors for \$1. Vito Pilioci . Ottawa Citizen, September 28, 2015

<sup>415</sup> PLASCO SALINAS VALLEY. Notice of Preparation/Initial Study, Prepared for Salinas Valley Solid Waste Authority. ESA, February 2012

<sup>416</sup> Personal notes, Task 33 site visit in October 2008

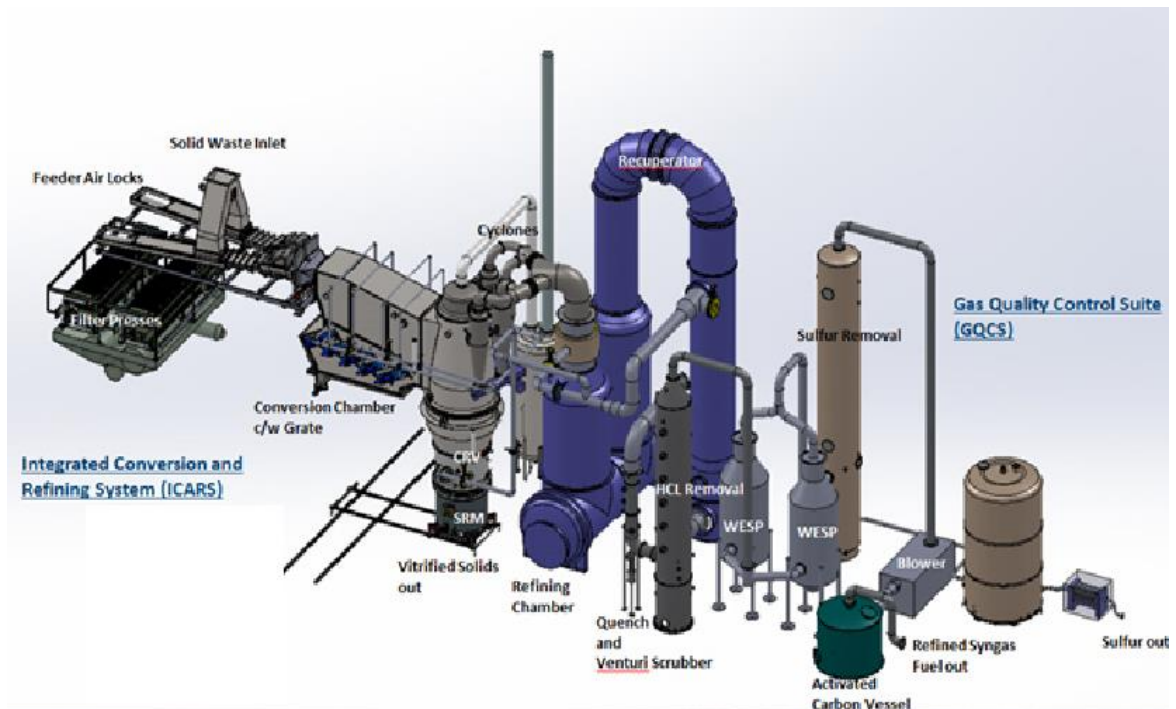

**Figure 77** The Plasco process lay-out<sup>399</sup>

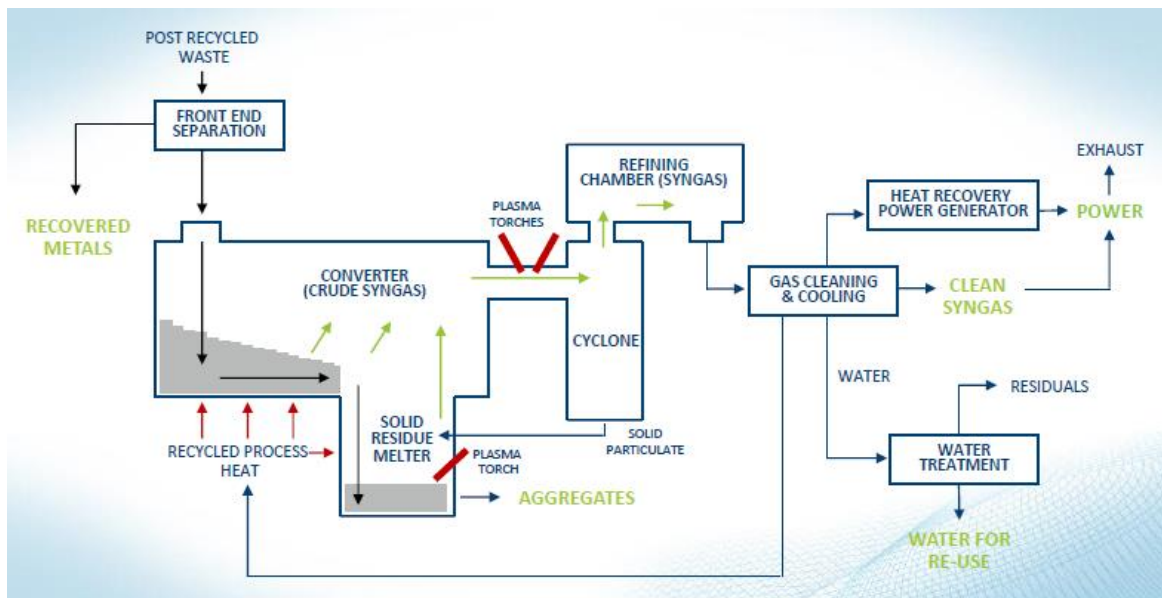

**Figure 78** The Plasco gasification system

The temperature on the grate, approximately 600 °C, is sufficient for drying and pyrolysis of the waste. Volatile elements in the waste, including hydrocarbons, hydrogen and CO and limited amounts of CO<sub>2</sub> are released from the pyrolysis and partial oxidation reactions. These gases flow to the refining chamber. The remaining waste solids at the outlet end of the grate are pushed into the carbon refining chamber. The undergrate ash is collected and is, together with cyclone ash and filter ash, also fed to the carbon recovery vessel.

The carbon recovery vessel, CRV, converts the fixed carbon from the residual material into additional product gas and hence improves the efficiency. The gas generated in the carbon recovery

vessel, after passing cyclones, rises into the conversion vessel, where it mixes with the gases from this vessel before all gases go to the refining chamber. The original process, as built at Trails Road, would use a 300-kW plasma torch in the carbon recovery vessel to achieve vitrification to create molten slag<sup>416</sup>. By water quenching the material rapidly cools to produce an inert, stable and non-hazardous aggregate. The recycling of fly ash to the carbon recovery vessel means that no fly ash residue is generated in addition to the agglomerates.

In the process described on the web page<sup>399</sup>, the carbon recovery vessel converts fixed carbon to syngas additional combustible gas while heating inorganics to melting point by flue gases coming from a bottom section, the solid residue melter, SRM, separated from the carbon recovery section by a grate. Below the grate, preheated air enriched with oxygen is used to drive a gas burner to deliver heat while two oxy-gas burners maintain slag in liquid phase. Natural gas or propane provides < 5% of the total energy entering of the overall system. The melt is withdrawn from the bottom of the solid residue melter to form agglomerates. Gases are transferred to the refining chamber.

The refining mixer at the inlet of the refining chamber provides turbulent mixing of raw product gas and preheated air or oxygen, and then exposes syngas to plasma plumes. Two 300 kW plasma torches<sup>416</sup> are used for refining and catalysis to crack tars, not as a primary heat source. The product gas leaving the mixer is held for 5 seconds at approximately 1000 °C in the refining chamber to complete cracking reactions, then moves on to a recuperator heat exchanger. As the gas passes through the plasma cloud, the long-chain molecules are "cracked" into their elemental components such as H<sub>2</sub>, CO and other simple molecules, and where the H<sub>2</sub> and CO carries most of the gas fuel value.

The recuperator heats process air, while cooling the syngas. Some process air is used in the gasification process, but most can be used to e.g. produce steam or to dry waste. The syngas is further cooled in a process quench vessel, this was the original design in 2006<sup>417</sup>. In 2011, a recuperator to pre-heat the air was installed, which cooled the gas to 750 °C upstream of the quench<sup>418</sup>. Re-formation of dioxins and furans is prevented by ensuring there is no oxygen in the syngas rapid cooling in the recuperator and subsequent water quench before passing on to the gas cleaning system.

Particulate and other contaminants would be removed from the gas stream. In the original pilot plant, this was done by conventional baghouse filter and where a mixture of activated carbon and feldspar was injected into the gas<sup>416, 417</sup>. The current description of the process includes instead a variable throat Venturi scrubber<sup>399, 415</sup>. The water droplets would be separated from the gas in a cyclone separator with the main liquid stream recirculating back to the Venturi scrubber and a particulate slurry flowing to the on-site recovered water treatment system<sup>415</sup>. However, in the flow sheet above, taken from the web page<sup>399</sup>, WESPs are used for this service. In an intermediate design<sup>418</sup>, the bag-house was relocated to a position downstream the hydrogen sulphide scrubber, see below.

After the baghouse filter, or the wet scrubbing system, the syngas passes through a HCl scrubber, a spray tower using sodium hydroxide as scrubbing fluid. Apart from removing HCl, it condenses moisture from the syngas to improve the heating value of the gas. The effluent that is sent to the water treatment system for treatment and recycling.

---

<sup>417</sup> Ontario Ministry of the Environment. Certificate of Approval Air. Number 6925-6REN9E. December 1, 2006

<sup>418</sup> Ontario Ministry of the Environment. Certificate of Approval Air. Number 4315-8JVP3K. October 24, 2011

Originally, a packed bed of sulphur-impregnated carbon was installed after the HCl scrubber to eliminate contaminants remaining, mainly absorbing Hg<sup>416, 417</sup>. This was later relocated to after the syngas blower, see below.

To remove sulphur in the form of H<sub>2</sub>S, an absorption liquid oxidation system is used. The original pilot plant used the Shell Paques process<sup>419</sup>, whereby a mild alkaline solution absorbs the H<sub>2</sub>S in a packed tower and the bisulphide-rich solution is routed a bioreactor to which a controlled amount of air. Naturally occurring bacteria (*Thiobacillus* spp.) oxidises the bisulphide ions to elemental sulphur, which is separated from the solution. The oxidation process produces hydroxide ions that effectively regenerate the alkaline solution used in the absorption step. This appears to later have been replaced by the Sulfcats process, a liquid oxidation process using an alkaline suspension of metal iron on an activated carbon carrier<sup>420, 418</sup>.

The cleaned gas passes a syngas blower that maintains the system at negative pressure and raises the pressure before sending the gas to the gas holder at low pressure. From the gas holder, the gas is fed to the gas engines. The gas engines are fitted with oxidation and SCR catalysts as required.

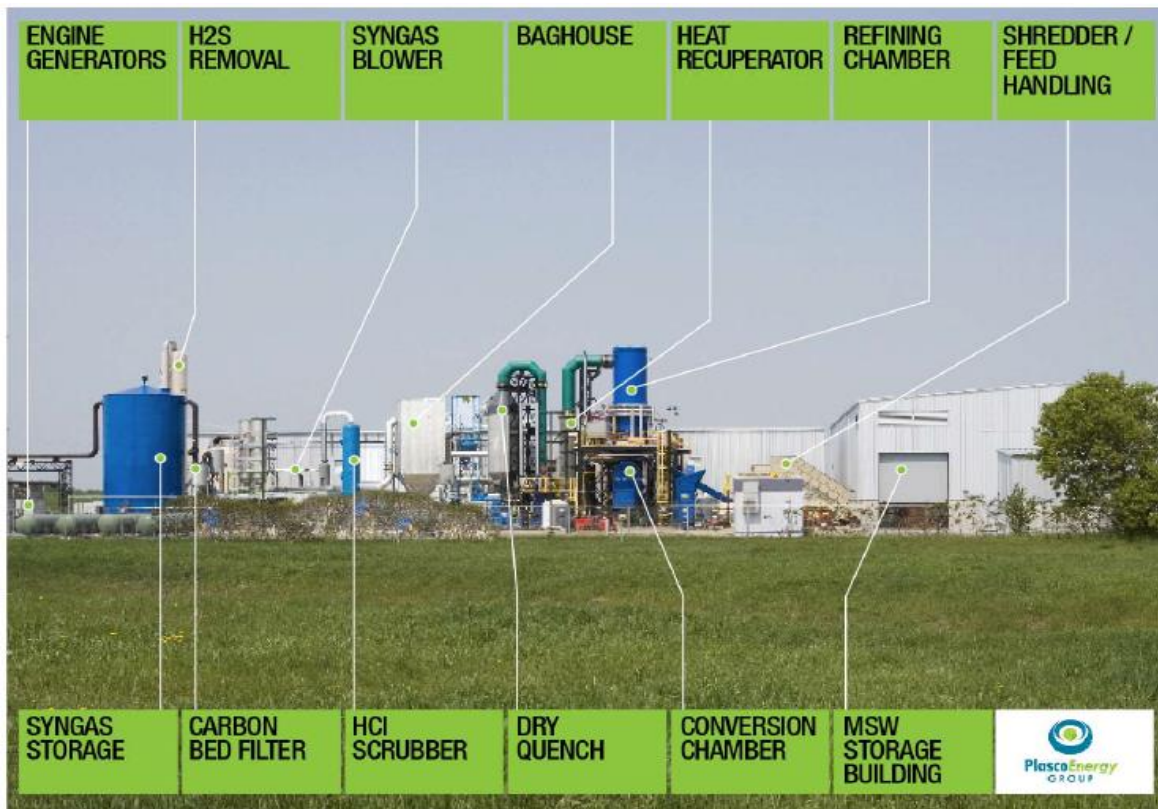

**Figure 79 A photo of the Trail Road pilot plant with process units indicated<sup>421</sup>**

The Trail Road facility was simplified, Figure 79, in particular with regard to energy optimisation, so the energy recovery from the engine for a full-scale commercial plant, excess heat from the process and the engines would be recovered to drive a steam bottoming cycle to increase the power production further.

<sup>419</sup> THIOPAQ O&G. Technology for the removal and conversion of hydrogen sulphide (H<sub>2</sub>S). Shell Global Solutions, 2011  
<sup>420</sup> Innovative H<sub>2</sub>S Gas Treatment Technology. Peter Ristevski. 2016 Gasification and Syngas Technologies Conference.  
<sup>421</sup> Plasco Energy Group. Public Meeting June 2008

In energy terms, the data for the Trail Road facility are not very clear. The net generation according to the air permits<sup>417, 418</sup> and the site visit<sup>416</sup> indicate a gross generation of round 4.5 MW. Some data, albeit from 2008, indicate that the gross generation was 5.2 MW internal load was 1 MW<sup>422</sup>. A previously cited report<sup>295</sup> from 2016 gives the operating time to > 3 000 hours and indicate that the plant output was 4.2 MW from 12 MW input, whereas in another part of the same report, higher numbers are cited. However, since the Plasco presentations are not quite clear on what is the output of the pilot plant and what would be the output of an optimised commercial unit of the same size, the numbers may have been confused. The site visit notes<sup>416</sup> had a figure for gross efficiency of 27 % for the pilot facility and 31 % for a plant with a bottoming cycle.

As noted above, there is little information on the actual operating record of the Trail Road facility. It appears that the emission and environmental permit conditions were met. Plasco Energy published a summary report for the period 2008-2011<sup>423</sup> that shows an increasing trend in terms of waste processed and power generated. Nevertheless, the plant was only operated for around 100 days in any year, and it is claimed that most of the operating time the syngas was of "engine quality". Even so, the power production in 2010 only amounts to 100 kWh/tonne of waste, indicating that engine operation time was far less than the gasification system operating time. In 2010, there was also an "availability test" of 21 days nominal in late 2010. The actual operating time was 15 days of which the engine was operated 10.5 days. The recorded waste processed however indicates that in average only approximately 60 % of the nominal capacity was reached during the operating period, and regarding power generated (presumably gross), the average power production per tonne of waste weighted on runtime would only be double the figure above. The report, however, concludes that "this 21-day availability test also demonstrated that the conversion efficiency of the system matched the Plasco financial model", so a far higher conversion efficiency may have been demonstrated for a shorter period but with data not disclosed in the above report.

### **7.3.2.6. Schwarze Pumpe, Germany**

The former East-Germany, or German Democratic Republic, GDR, government initiated large-scale open pit mining and use of lignite, the only significant indigenous energy resource in the GDR, in the Schwarze Pumpe area in the mid-1950s<sup>424</sup>. Initially, the activities were mainly in preparing briquettes for use elsewhere but gradually it also included coke manufacturing, power plants and finally, in the mid-1960s also generation of town gas. The Gaskombinate Schwarze Pumpe had by then grown to a large complex with overall 40 000 employees in several locations in the GDR and 15 000 employees in Schwarze Pumpe.

The town gas plant at Schwarze Pumpe started production in 1964 with 24 Lurgi-type fixed bed gasifiers<sup>425</sup>. In 1969, also several entrained flow gasifiers were added to gasify lignite dust and some tar fractions from the fixed bed gasifiers<sup>426</sup>. Schwarze Pumpe, via a national pipeline distribution system, finally supplied about 75 % of the total town gas consumption of the GDR, distributed all over GDR, before the start of gas imports from the Soviet Union in 1973, which were routed to and distributed via the complex. At the peak, it produced 6 million Nm<sup>3</sup> of town gas per day.

After the German unification, the Gaskombinate came in the hands of the Treuhandanstalt<sup>427</sup> and in 1995 the gas generation part was taken over by the local water utility of Berlin, BWB, partially as a

<sup>422</sup> Aitkin County Plasma Gasification Study. Does it make sense to move forward with a full feasibility analysis? Northspan Group, Inc., April 2008

<sup>423</sup> Summary of Operation of Plasco Trail Road – Demonstration Period. (2008 to 2011). Plasco energy group

<sup>424</sup> [https://de.wikipedia.org/wiki/Industriepark\\_Schwarze\\_Pumpe](https://de.wikipedia.org/wiki/Industriepark_Schwarze_Pumpe)

<sup>425</sup> Operational Results from Gasification of Waste Material and Biomass in Fixed Bed and Circulating Fluidised Bed Gasifiers. C. Greil et al. IChemE Conference, "Gasification: The Clean Choice for Carbon Management." Noordwijk, the Netherlands, April 2002.

<sup>426</sup> Gasification. Chris Higman and Maarten van der Burgt, Elsevier, 2003.

<sup>427</sup> Braunkohleveredelung im Niederlausitzer Revier. 50 Jahre Schwarze Pumpe. Ed. Günter Bayerl. Vaxman Verlag GmbH, 2009

precautionary measure as the Gaskombinate complex with open pits and polluting industries was located in the Spree valley upstream of the city<sup>428,429</sup>. In the years to come, and after making major investments, the town gas production plants were converted in 1992 to a recycling plant where various forms of wastes (sludges, plastics, contaminated oils, etc.) were gasified and used to produce electric power and methanol under the name of Sekundärrohstoff-Verwertungszentrum Schwarze Pumpe GmbH (SVZ).

In addition to the seven fixed bed gasifiers and two entrained flow gasifiers from the GDR days that were retained in operation after revamping, the first industrial application of the British Gas Lurgi Slagging Gasifier (BGL) was installed in 2000 and was in regular operation as of 2003, while two more gasifiers were planned to be installed by 2005. However, the company could not get into black numbers and BWB sold it to a group of German investors in 2002. However, these were not more successful than the previous owner, and went into insolvency in 2004<sup>430</sup>. The company was then bought by the Swiss company Sustec Holdings, but the economic problems continued and its withdrawal from the waste business in 2007, and the plant operation was discontinued. The overall plant flowsheet is shown in Figure 80.

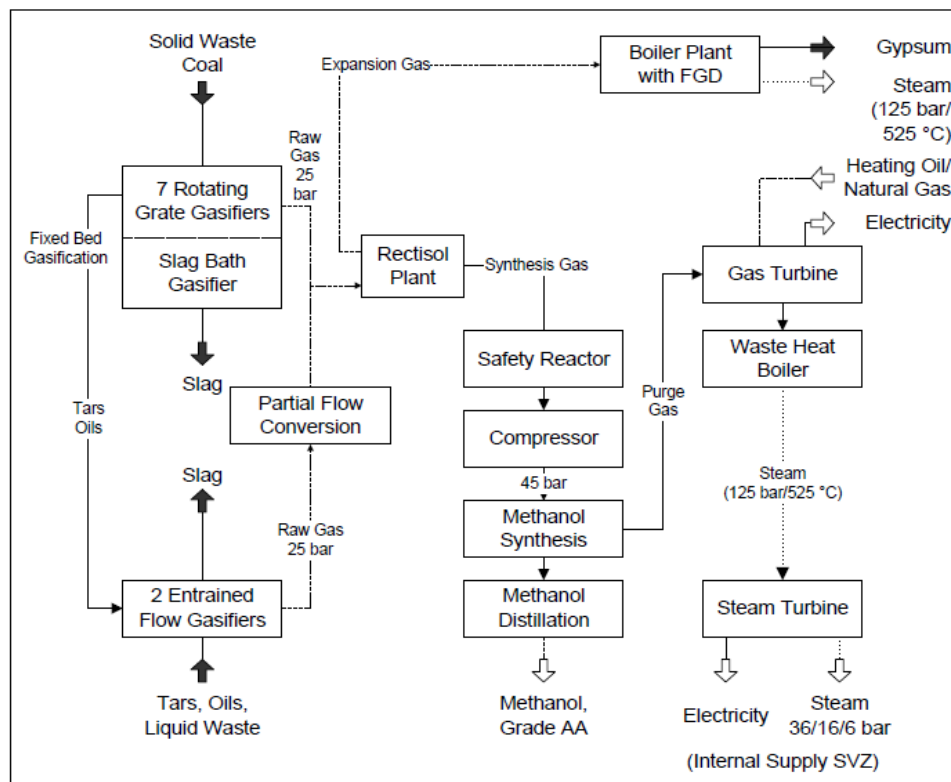

**Figure 80** Block flow diagram of the SVZ Schwarze Pumpe plant<sup>295</sup>.

The fixed bed gasifiers and the BGL gasifier were fed with lignite briquettes and various waste that were pre-treated in the plant to pellets and briquettes. The feed included RDF pellets, compacted plastic waste, recycle and contaminated wood as chips, sewage sludge briquettes, tar sludge pellets and shredder light fraction. Only four gasifiers and the BGL gasifier were permitted to operate on waste at any time. The fixed bed gasifiers had a nominal capacity of 15.5 tonnes/h each and were

<sup>428</sup> Schwarze Pumpe saniert Teer-Seen. Die Welt, 29.06.1999

<sup>429</sup> Biometanolproduktion i Schwarze Pumpe i Tyskland. Tomas Ekbohm, Nykomb Synergetics, 2001-10-01

<sup>430</sup> Millionenpleite in Schwarze Pumpe. Der Tagesspiegel 27.04.2004

operated with steam and oxygen at 2.7 MPa. Overall 444 000 tonnes of feedstock were allowed annually. The BGL gasifier operated with oxygen and steam at 2.5 MPa and had a capacity of 39 tonnes/h and was permitted to process 312 000 tonnes of wastes per year, in addition to lignite and hard coal. The fixed bed gasifiers had a typical initial gas cleaning to remove tars and solids by quenching and scrubbing. The plant had since 1969 also two oxygen-blown entrained flow gasifiers operating at 2.5 MPa with a capacity of 15 tonnes/h each. The feedstock was primarily waste tars produced in the fixed bed gasifiers, but also other oil fractions and sludges that could be dewatered to a slurry. These gasifiers had been developed in the GDR by Noell and were known as GSP gasifiers. After the German unification, the technology formed the basis for both the Lurgi multi-purpose gasifier (MPG) and also, via Babcock and Future Energy, of the current Siemens coal gasification technology. The gas from the gasifiers were quenched and scrubbed prior to a partial shift to adjust the H<sub>2</sub>/CO ratio. The combined gas flows from fixed bed, slagging and entrained flow gasifiers, respectively, were then treated in a Rectisol unit for the removal of sulphur compounds and CO<sub>2</sub>. Part of the cleaned gas, 50000 Nm<sup>3</sup>/h at an LCV of 12 - 16 MJ/Nm<sup>3</sup> was routed directly to the combined cycle plant to provide a net electric output, while also purge gases from the methanol loop, 20 000 Nm<sup>3</sup>/h at an LCV of 17 MJ/Nm<sup>3</sup>, was used in the gas turbine<sup>429</sup>. The combined cycle plant that was taken into operation in 1998 produced in total 75 MW electric, of which 45 MW from a GE PG 6551 B gas turbine, and also generated steam for the gasifiers and as utility steam for the plant<sup>431</sup>.

The methanol plant operated at 4.0 MPa and the productivity ramped up from an initial 35 000 tonnes per year to over 100 000 tonnes/year in later years.

Gasification of solid waste materials as well as lignite and hard coal in variable mixing ratios was only allowed in four of the seven existing fixed bed gasifiers at a time, in the BGL gasifier and in the entrained flow gasifiers with a maximum share of 85 % waste in the feedstock.

The plant processed 300 000 tonnes in 2001 of which 75 % was wastes. The annual capacity of the methanol plant that came into operation in 1998 was later expanded to 120 000 tonnes/year. In addition, 340 GWh of power was produced<sup>429</sup>. Since most of the feedstock was converted to gas, including tar oil, dust and soot, the overall efficiency of the installation to power and methanol was high.

Since the plant is no longer in operation and since a cited report<sup>295</sup> has an excellent description of the plant with photos and graphics, interest readers are referred to this reference for further information.

### **7.3.2.7. Syngas Products (fka NEAT)<sup>432</sup>**

New Earth Solutions was formed in 2002. Its core business is recycling of waste. New Earth Solutions has developed sustainable waste management facilities, including at Avonmouth, UK, where also a waste to energy plant was developed. The mechanical and biological treatment plant at Avonmouth has been operational since April 2011 and can process up to 250 000 tonnes of waste per year<sup>433</sup>. In 2008 New Earth Technology was formed to engage in waste-to-energy projects. In 2009, investors injected 15 million GBP<sup>434</sup>, of which 4 million GBP from the UK Carbon Trust to finance the expansion<sup>435</sup>. In 2010 the company received the permit<sup>436</sup> for a waste to energy facility that was later expanded. In the end, the plant was expanded to process 120 000 tonnes per year of

<sup>431</sup> Operating Results of the BGL Gasifier at Schwarze Pumpe Hans-Joachim Sander, Georg Daradimos, Hansjobst Hirschfelder. San Francisco, California October 12-15, 2003

<sup>432</sup> [www.syngas-products.com](http://www.syngas-products.com)

<sup>433</sup> New Earth Solutions Avonmouth Facility. New Earth Solution, undated

<sup>434</sup> <https://www.ft.com/content/5580d620-8604-11de-98de-00144feabdc0>

<sup>435</sup> <http://www.finalalternatives.com/node/10959>

<sup>436</sup> Waste Management, 12.11.2010



RDF from the New Earth Solutions recycling plant in 16 parallel processing units. The power output was 13 MW<sub>e</sub><sup>437</sup>, of which 1 MW<sub>e</sub> was used internally and another 1 MW<sub>e</sub> was sold directly to the waste recycling facility.

The first phase came into operation in 2013 and the second phase the year after. The flow schematic of the process is shown in Figure 81. The process is described more in detail below. However, the Avonmouth plant did not use engines to generate power, instead the gas from the 16 units, 1 tonnes/h each, was combusted in two boilers and the energy recovered as steam to drive a steam turbine<sup>438</sup>. The business idea was to process RDF that would otherwise be exported outside the UK at cost, and to have the revenue of ROCs from selling power.

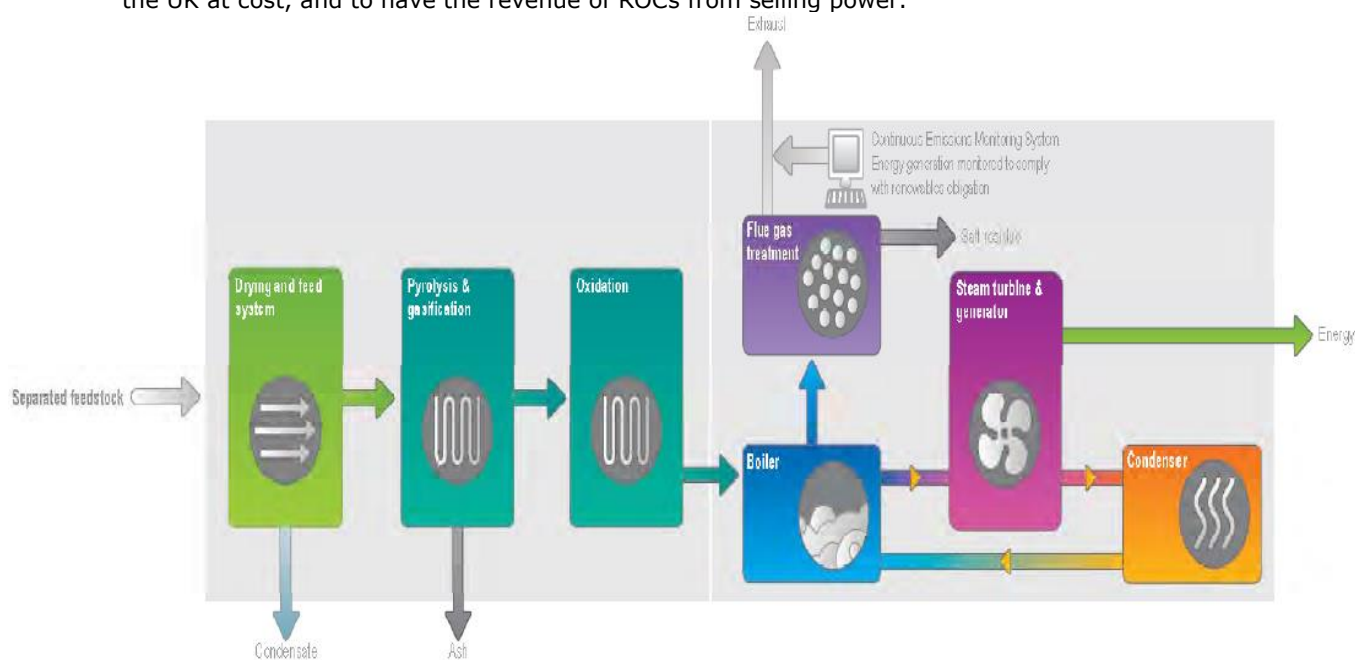

**Figure 81 The NEAT Avonmouth schematic flowsheet<sup>438</sup>**

However, the plant operation did not meet expectations partially blamed on the RDF quality and partially for other reasons, and in 2015, New Energy Solutions decided to divest the plant<sup>439</sup>. The New Earth group was broken up, and the ownership and financing of the plant and energy business transferred in July 2015 to Aurium Capital Markets and Macquarie Bank, alongside Syngas Products Group Ltd, which provided the technology for the plant. The transferred companies, after a financial injection, was renamed to Avonmouth Bio Power<sup>440</sup>. However, the move did not improve the operations and the plant operation was suspended in 2016 and planned to be resumed in 2018. However, the annual report of Avonmouth Biopower in 2017 postpones the re-opening to 2020<sup>441</sup>.

Gasification technology supplier NEAT Technology within Avonmouth Biopower Energy was demerged in 2015 and has renamed itself as Syngas Systems<sup>442</sup>. The company has installed its own demonstration facility at the Canford Energy Recovery Facility, Dorset, claimed to use a second-generation technology relative to the Avonmouth plant. The pre-production modular demonstration unit has a nominal capacity of 10 000 tonnes per year input and 0.8 MW<sub>e</sub> output and is used for

<sup>437</sup> 13 MW RDF Pyrolysis & Gasification Plant Starts Up in Avonmouth. Waste Management, 18.06.2013

<sup>438</sup> New Earth Energy Ltd. Avonmouth Low Carbon Energy Facility. Environmental Statement. Non-Technical Summary, June 2010

<sup>439</sup> UK company's energy-from-waste plans stall out. Waste Today, October 16, 2015

<sup>440</sup> Troubled gasification plant to stay closed until 2018. Edward Perchard. Resource, 5 January 2017

<sup>441</sup> Avonmouth Biopower Energy P Ltd. Annual report and financial statements for year ending 31 August 2017

<sup>442</sup> NEAT Technology rebrands as Syngas Systems. Gareth Simkins. ENDS Waste & Bioenergy 26 February 2015 by

development activities. The R&D activities began in 2013 at Avonmouth to prove the production of clean product and initially involved three independent test rigs were relocated to Canford in 2016 and incorporated into a fully integrated system including a spark ignition gas engine for electricity generation. There is also a planning permission and the grid connection are in place to expand the facility up to 100 000 tonnes per year to generate 8 MW<sub>e</sub>, however a final investment decision has not yet been taken.

The second-generation process<sup>443</sup>, see Figure 82, is composed of feedstock pre-treatment and storage, pyrolysis chamber, gasifier, pyrogas clean up system and syngas combustor. The feedstock for the facility will be primarily derived from residual waste treated waste recycling facility.

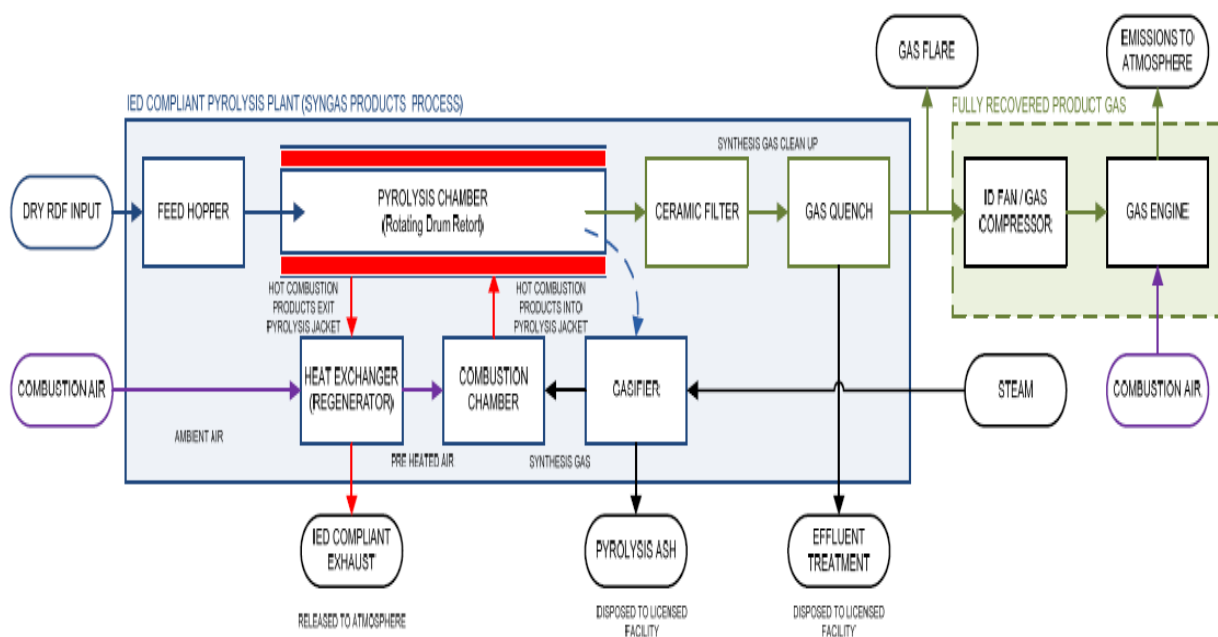

**Figure 82 The second-generation Syngas Products "NEAT" technology<sup>443</sup>**

The raw feedstock will undergo further processing within a fully enclosed building through a combination of blending, shredding, polishing and drying down to 20 % moisture. All feedstock will be held within a buffer store. Internal conveyors will then distribute the feedstock to a number of pyrolysis units, each processing 1 tonne/h. Each pyrolysis unit is fed via an enclosed auger screw conveyor that by means of a piston against a closed gate valve compress the incoming material to create a plug seal and to remove any intrinsic air in the feedstock and it is delivered directly into the pyrolysis chamber, a rotating drum retort, where the fuel is heated to a temperature of 850 – 1 000°C. The retention time is variable, but typically the feedstock remains in the chamber for 40 minutes. Within the pyrolysis chamber, the feedstock will be heated to a high temperature in the absence of oxygen, where it will break down into a pyrolysis gas and a solid carbon char. The pyrolysis gas produced in the pyrolysis chamber is a mixture of light gases, heavier gases and condensable organics. The light gases, which comprise the main fraction, include hydrogen, carbon monoxide, carbon dioxide, methane and ethane and similar short chain hydrocarbons as well as contaminant compounds (chlorine, sulphur etc).

The pyrolysis gas from the pyrolysis process is drawn, under negative pressure, through a heated ceramic filter to remove particulates and collect the char from pyrolysis. After the filter, the hot

<sup>443</sup> EPR SWIP Permit Application Support Document. Canford Low Carbon Energy Facility. Syngas Products Ltd. Sol Environment Ltd. October 2015. Small Waste Incineration Plant

gases pass through a wet quench, to rapidly reduce temperature to condense out the tars and oils and prevent de novo dioxin formation. This quench is pH dosed with chemicals, NaOH and NaClO, to remove acid gases such as HCl, HF and H<sub>2</sub>S, respectively. This stage also removes any moisture present within the gas.

The cleaned gas LCV is 18 – 22 MJ/Nm<sup>3</sup> (or greater) and the gas is clean enough to meet End-of-Waste conditions. The clean synthesis gas can be used in a multitude of industrial applications the most applicable being electrical generation using gas engines.

The cleaned pyrolysis gas is stored within a buffer tank before being fed into a common header for one or more gas engines that generate electricity. Exhaust gases will be released to atmosphere via a dedicated flue stack. Heat will be recovered from the engine cooling jacket and exhaust.

The char and particulate collected in the ceramic filter has a residual chemical energy which is used to heat the pyrolysis drum. This energy is liberated in the gasifier to produce a low-grade gasification gas. The gasification of the pyrolysis char is achieved by injecting a controlled ratio of steam and air through a bed of char in a gasification chamber at approximately 900°C. This chamber is continually filled by the char feed system. The resultant gasifier gas is then directly combusted within a dedicated combustion chamber to provide the heat for the pyrolysis drum, which is transferred indirectly from an annular space on the outside surface of the pyrolysis chamber. The use of heat recovered from the char ensures that a high level of thermal efficiency is achieved by the primary process.

The flue gases from all pyrolysis lines are then collected to one duct, cooled and cleaned by conventional flue gas cleaning methods. The flue gas cleaning consists of dry in-stack scrubbing using sodium bicarbonate to remove residual acid gases, followed by separately dosed powdered activated carbon (PAC) to remove volatile heavy metals, organic compounds and residual dioxins and furans by adsorption, and, finally, there is a downstream fabric filter to capture the dry scrubbing chemicals containing the adsorbed pollutants prior to exhaust. The fly ash from the gasifier that is collected in the bag filter will be disposed of at a suitably permitted facility.

From the data in the application, one line of processing with a capacity of 1 tonnes/hr with an LCV of 12.6 MJ could produce 1.4 MW<sub>e</sub> gross, i.e. and efficiency of 28 %. However, the source does not contain any data to elucidate the net efficiency.

#### **7.3.2.8. Synnov Déchets, Villers-sous-Montrond**

In addition to the ESKA plant, see Section 7.1.4, which is from many aspects a replication of the TPS gasification technology installed in the Greve-in Chianti plant in the late 1980s, LLT has an on-going development of the circulating fluidized bed technology to also include hot gas cleaning. For this purpose, the company has invested in a pilot plant in Nantes, France, that became operational in 2017. This plant can be used as a CFB combustor at 1 MW thermal capacity or as a gasifier with 2 MW thermal capacity<sup>444</sup>. For the later application the plant also has a thermal tar cleaning gas treatment downstream of the gasifier.

The first commercial use of this technology will be for Synnov Déchets in Villers-sous-Montrond in France<sup>445, 446, 447</sup> (Figure 83). Synnov Déchets is a joint venture with participation of the Bonnefoy

<sup>444</sup> INNOV'ENERGY, NANTES [F]. 2 MWth Multifuel Fired Fluidized Bed Boiler—R&D Pilot Facility. PROJECT REVIEW. LEROUX & LOTZ TECHNOLOGIES. Undated

<sup>445</sup> Lancement de la première centrale de gazéification des déchets du bâtiment en Bourgogne-Franche-Comté. Bonnefoy Groupe. Communiqué de Presse. Jeudi 27 Octobre 2016

<sup>446</sup> Multifuel gasification plant revealed. Luke Wals. ENDS Waste & Bioenergy. 4 November 2016.

<sup>447</sup> Personal communication. Jan Hoogerdijsk. LLT

Group, a waste management company and other interests, including LLT. The plant, which has a capacity of over 7 MW<sub>e</sub> and 12 MW<sub>th</sub> will process 45 000 tonnes per year of SRF and recycle wood to produce 52 GWh of electricity and 90 GWh of heat. The published cost is 34 million €. The start-up is planned for 2018.

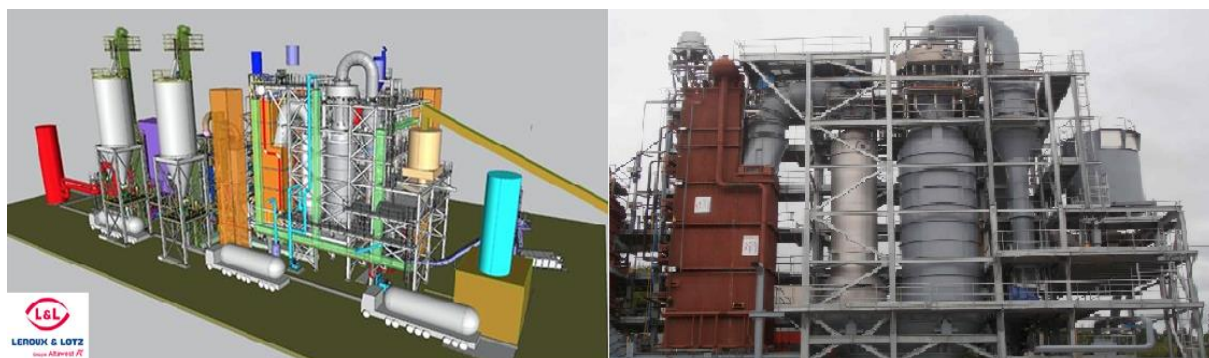

**Figure 83 The Synnov Déchets Viller-sur-Montrond plant<sup>448</sup>**

The plant will gasify<sup>449</sup> the waste at 750-850 °C and uses thermal treatment of the raw product gas in a vertical vessel operated at 1050-1100 °C with a residence time above 2 s. The gas is dedusted in a cyclone before being cooled in a series of heat exchangers: gas-gas, gas-air, gas-steam evaporator, gas-economizer, gas-water preheater and gas-air to 175 °C. This is followed by a dry cleaning system using hydrated lime and activated carbon, followed by cooling and condensing of steam. The final cleaning is done in a bag filter and by sulphur removal using activated carbon. The gas is slightly pressurized and sent to gas engines generating 5.3 MW<sub>e</sub> and a steam bottoming cycle of 1.6 MW<sub>e</sub>. In addition, 12 MW heat is recovered for use in adjacent third-party industrial installations.

### **7.3.2.9. SynTech Bioenergy/KEW Technology, UK**

SynTech Bioenergy LLC, of Denver, CO, USA completed an agreement in December 2016 to build a 'first of its kind' commercial scale advanced thermochemical waste to energy facility in the UK in partnership with the Energy Technologies Institute (ETI). ETI will invest 5 million GBP in the project with a matching investment from SynTech Bioenergy LLC<sup>450</sup>. The total investment in the projects is 10.5 million GBP<sup>451</sup>. The Project was initially led by SynTech Bioenergy UK but has recently been taken over by KEW Technology Ltd<sup>452</sup> (on ETI's web page the investment is currently indicated to 8 million GBP). The project was the winning contender in a project competition which also involved APP and Synova (*fka* Royal Dahlman<sup>453</sup>), see Sections 7.4.2.1 and 7.4.2.5, respectively.

The plant, also known as SynTech Energy Centre, is located at Portway Road, Wednesbury, West Midlands. The plant will complete commissioning in December 2017 and be fully operational by March 2018<sup>454</sup>. An extensive demonstration campaign over 8000 operating hours will follow, with involvement from Lender's Technical Advisors.

The plant will have a capacity of about 40 tonnes/day of RDF produced locally into a clean product gas. The gas will be used in a modified high-efficiency gas engine to generate 1.5 MW<sub>e</sub>, while the

<sup>448</sup> Courtesy of LLT

<sup>449</sup> Arrête 25-2017-08-22-007. Le préfet de Doubs.

<sup>450</sup> waste-management-world.com/a/1-5mw-advanced-thermochemical-waste-to-energy-project-from-syntech-uk-eti

<sup>451</sup> Targeting New and Cleaner Uses for Wastes and Biomass Using Gasification. Energy Technologies Institute, 2017

<sup>452</sup> How waste gasification can clean up its ACT. James Varley. Modern Power Systems April 5, 2018.

<sup>453</sup> www.eti.co.uk/programmes/bioenergy/waste-gasification-commercial-development-plant

<sup>454</sup> SynTech Energy Centre. High Efficiency ACT Commercial Demonstrator Plant. Kamal Kalsi "Case Studies of Innovation in ACT". 22-24 May 2017

waste heat generated from the engine will supply heat to a local swimming pool. It will also incorporate a test facility to test new engines, turbines and processes which chemically converts the cleaned product gas syngas into products, including a proprietary methanol production process<sup>455</sup>.

The gasification technology, FluiMax, is being provided by the US company Frontline Bioenergy, a subsidiary to Synthech Bioenergy LLC<sup>456</sup>. Frontline is a developer of air and oxygen-blown, pressurized, bubbling fluid bed gasifiers, proprietary hot gas filtration and other gas conditioning technologies<sup>457</sup>, see Figure 84. However, the gas cleaning part of the plant, starting from a high temperature thermal tar converter and going down to ambient temperature<sup>458</sup> is provided by KEW Technologies Ltd<sup>459</sup>.

No specific process description has been found for the project. However, the project with ETI was initiated with the company Broadcrown as the main developer for a 3.3 MWe plant based on the same technology, which was later changed for the current stakeholders<sup>451</sup>. The following description is taken from the permit<sup>460</sup> "Pre-treated received wastes Refuse Derived Fuel (RDF) and Solid Recovered Fuel (SRF) (RDF/SRF to CEN/ISO 15359) will be stored in a reception hall. The hall will be kept under negative pressure with air being drawn through combustion units. The waste will be shredded, dried and cubed to prepare the material for the gasification process.

The waste will then be fed into the gasifier which will be a bubbling fluidized bed system that will operate at 740-900 °C. The bed material will be kaolinite-based fired clay. The fluidising agent will be a mixture of oxygen and steam. A cyclone will remove 80-90% of entrained particulate matter from the syngas with the remainder removed in later clean up stages.

The syngas will also contain tars which will be reformed in a thermal cracking stage where the syngas will be heated to 1050-1200 °C through injection of oxygen. The syngas will then be cooled with energy recovery and steam generation to feed back into the gasifier. After cooling to ~160 °C, activated carbon and sodium bicarbonate will be injected before passing through a ceramic filtration plant. The syngas will then be quenched and scrubbed to remove any remaining acid and ammonia and then finally through an activated carbon column to remove remaining hydrogen sulphide.

The clean syngas will then be burned in low NO<sub>x</sub> gas engines to generate electricity. The syngas will be classed as a non-waste at this point in that when burned it will be not cause emissions higher than those resulting from the burning of natural gas. Emissions will be abated using SCR with urea".

To what extent the above description has changed in any material way is not known.

It is also noted in the ETI report cited above that the technology developed as part of the Broadcrown project met the end-of-waste criterion of the EID<sup>451</sup>.

The project participants are also engaged in an ERA-NET BESTF project, Phoenix, with the purpose to validate a new concept for the gasification unit-gas engine interface to raise efficiency of the engine<sup>458</sup>.

---

<sup>455</sup> [www.eti.co.uk/news/work-starts-on-eti-backed-innovative-waste-gasification-commercial-demonstration-plant-in-the-west-midlands](http://www.eti.co.uk/news/work-starts-on-eti-backed-innovative-waste-gasification-commercial-demonstration-plant-in-the-west-midlands)

<sup>456</sup> [www.frontlinebioenergy.com/index.cfm/19893/38584/frontline\\_agrees\\_to\\_become\\_whollyowned\\_subsidary\\_of\\_syntech\\_bioenergy](http://www.frontlinebioenergy.com/index.cfm/19893/38584/frontline_agrees_to_become_whollyowned_subsidary_of_syntech_bioenergy)

<sup>457</sup> [www.biofuelsdigest.com/bdigest/2016/12/15/the-carbon-negative-power-machine-get-one-while-supplies-last/](http://www.biofuelsdigest.com/bdigest/2016/12/15/the-carbon-negative-power-machine-get-one-while-supplies-last/)

<sup>458</sup> Personal communication, Hans Månsson, KEW Technologies Ltd.

<sup>459</sup> [www.kew-tech.com](http://www.kew-tech.com)

<sup>460</sup> Wednesbury Advanced Conversion Plant Permit number EPR/WP3730EP. The Environment Agency, UK. 2 April 2014.

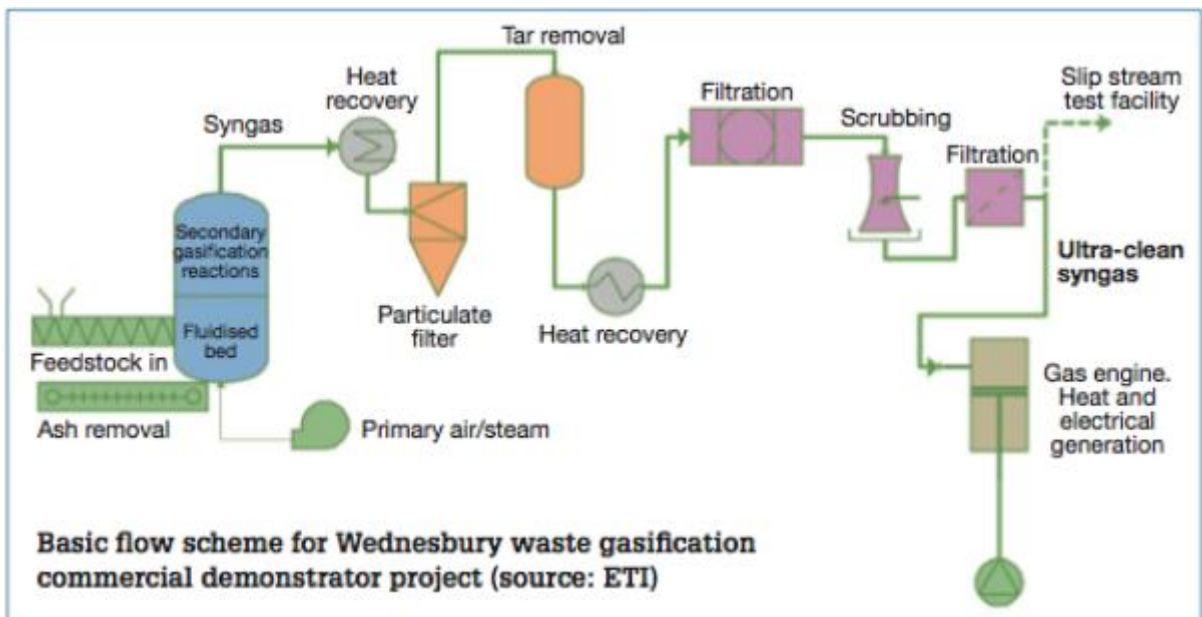

**Figure 84 General process scheme for the gasification system of Syntech Bioenergy UK<sup>452</sup>**

### 7.3.2.10. Taylor Biomass Energy, LLC, Montgomery, NY, USA<sup>461</sup>

The Taylor Bioenergy gasification process has its origin in the Battelle gasification process that in 1992 was licensed to and further exploited by Future Energy Resources Corporation, FERCO<sup>462</sup> as the Silvagas process. FERCO filed for bankruptcy<sup>463</sup> in 2002 after failing in a project in Burlington, VT. However, the company survived under the FERCO name to 2006 when it changed its name to Silvagas<sup>464</sup>. Silvagas was later taken over by Rentech in 2009<sup>465</sup> that in turn, sold its gasification and Fischer-Tropsch activities to the Chinese Kaidi group in 2014<sup>466</sup>, see Section 7.3.2.1. The development of the Taylor Bioenergy process started in 2005 and where an ex-Battelle/Ferco/Silvagas was instrumental<sup>467</sup>.

The Taylor company operates the Taylor Recycling Facility, LLC (TRF) in Montgomery, NY, and this is also where it plans to install the gasification plant. The process has this far been stretched out from 2006, and as far as known the construction has yet not been initiated. The project received the state and town permits in 2011 and 2012, respectively, and was also selected for a 100 million \$ loan guarantee from DOE<sup>468</sup>, and the latest news on the project was that in mid-2017 the CEO stated that financial closure could soon be reached<sup>469</sup> and that all permits were available, with the exception of building permit that has to be renewed beforehand. The project investment cost is estimated to 275 million \$US.

The project will be located at the current location of Taylor Recycling Facility (TRF) and will expand the Taylor sorting and separating process from 350 tonnes per day capacity to 900 tonnes per day of which half will be MSW, in addition to wood waste, and construction and demolition waste that is currently being processed in the recycling facility. The RDF fuel is to be used as feedstock to the

<sup>461</sup> <http://www.taylorbiomassenergy.com/>

<sup>462</sup> Verification of the Performance of Future Energy Resources' SilvaGas® Biomass Gasifier - Operating Experience in the Vermont Gasifier. Paisley, M. and Overend, R. Pittsburgh Coal Conference, Pittsburgh, PA, September 22-24, 2002.

<sup>463</sup> <https://www.bizjournals.com/atlanta/stories/2002/12/23/story1.html>

<sup>464</sup> <https://www.businesswire.com/news/home/20061023005411/en/FERCO-Enterprises-SilvaGas-Corporation-Focus-New-Project>

<sup>465</sup> <https://www.businesswire.com/news/home/20090707006181/en/Rentech-Completes-Acquisition-SilvaGas-Corporation-Advancing-Bio-Energy>

<sup>466</sup> Rentech closes on sale of alternative energy technologies. Erin Voegele. Biomass Magazine, November 06, 2014

<sup>467</sup> Full Steam Ahead. Anna Austin. Biomass Magazine, June 22, 2011

<sup>468</sup> Taylor Biomass Energy /Taylor Recycling Facility press release May 10, 2012

<sup>469</sup> <http://www.wastetodaymagazine.com/article/taylor-biomass-funding-september/>

gasification process, producing a medium calorific value product gas that will be used to generate net 20 MW<sub>e</sub> in a gas turbine combined cycle.

The design of the Taylor gasification process, Figure 85, uses three fluidized-bed reactors: a gasification reactor, a gas conditioning reactor, and a combustion reactor, respectively, all of them operating at close to atmospheric pressure. The gasification and combustion reactors are circulating fluidized beds, while the gas conditioning reactor is of the bubbling fluidized bed type. The fuel is fed to the gasifier reactor where it is devolatilized and partially gasified in steam at 750- 850 °C, and where a circulation of bed material from the combustor, at a weight rate of 15-30 times the biomass feed, flows via the conditioner reactors, respectively maintains the temperature. The solids are typically olivine or sand, depending on the fuel ash properties. The gas passes via a cyclone to the conditioner fluidized reactor where the contact at high temperature, 1000 °C, with bed material reduces the tar in the gas and also adjust the water gas shift reaction to come close to the equilibrium.

The cooled solids from the gasification reactor together with unreacted fuel char is drawn to the combustion reactor and is burned with air at 1000 °C, and thereby reheats the circulating bed solids, which are separated in a cyclone and returned to the conditioner reactor and thereafter to the gasifier reactor.

The product gas is cooled to ambient and compressed to 2.4 MPa, but no additional cleaning measures are detailed. TBE expects to use a Solar Titan 130 gas turbine of 17 MW<sub>e</sub> and an 8 MW<sub>e</sub> steam turbine bottoming cycle.

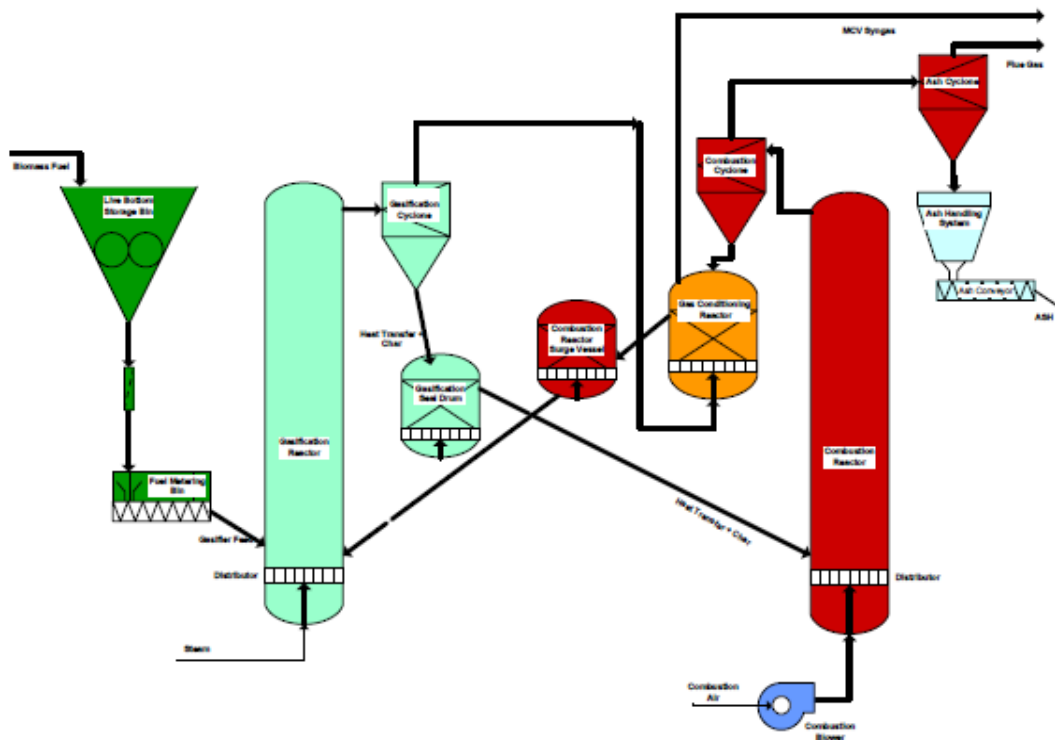

**Figure 85** The Taylor Biomass Energy gasification process schematics<sup>470</sup>

<sup>470</sup> Advanced Biomass Gasification for the Production of Biopower, Fuels, and Chemicals. Mark A. Paisley. AIChE Annual Meeting, November 5 - 9, 2007

### 7.3.2.11. Thermoselect and licensee JFE<sup>294, 295</sup>

The Thermoselect process was developed by the Swiss company Thermoselect since the 1980s and has been installed in 10 installations worldwide, see Table 36. This includes a demonstration plant at Fondotoce, Italy. Following Seveso and the realisation of dioxin emissions due to insufficient flue gas cleaning and also the discovery of the de novo synthesis in the flue gas system, the interest for different new thermal treatment technologies rose.

The commercial plant using the Thermoselect process was built in Karlsruhe, Germany in 1999 at a cost of 167 million €<sup>471</sup>. By that time, irregularities in the operation of the Fondotoce plant had been discovered and legal actions were taken by the Italian authorities leading to the closure and dismantling of the demonstration plant.

The Karlsruhe plant had a throughput of 225 000 tonnes/year or 3\*10 tonnes/h. With a nominal heating value of the fuel of 12 MJ/kg this corresponds to 100 MW thermal input in total. The gas was burned in two boilers feeding into a common steam turbine. The output was 12.7 MW<sub>e</sub> gross and 10 MW<sub>e</sub> net plus 50 MW<sub>th</sub> as district heating. The plant had severe operating difficulties also affecting the economics and was closed in 2004. Orders were cancelled and a second plant at Ansbach, Germany that had been constructed was never taken into operation. The closure of the Karlsruhe plant was followed by damage claims and court procedures. This eventually led to the bankruptcy of the Thermoselect S.A company in 2010, but the IPR is now held by Thermoselect AG and technology is still available via Viverra Corporation, both registered in Lichtenstein.

In the 1990s, JFE (merged from *fka* Kawasaki Steel Corporation and NKK Corporation 2001, the former company licensing the technology in 1997) of Japan became interested in the Thermoselect process and, in 1999, started up the first Thermoselect plant in Japan at Chiba to Tokyo. The overall cost of the Chiba facility was reported to be 80 million \$US, with 13 million \$US of annual operating expenditures<sup>472</sup>.

Eventually, the company built another six plants, five of which used Jenbacher engines, and in one case also a steam bottoming cycle (Yorii), one used a steam cycle (Izumi) and one produced fuel gas (Okayama), which was also partially the case at Chiba. However, after the experiences of these plants and the economic fallout the company stopped marketing the technology<sup>473</sup> and instead put efforts into the shaft gasification and melting technology.

However, in the mid-2000, a project was initiated in Italy, targeting the ill-reputed waste management and landfill site of Malagrotta, Lazio, outside Rome, to reduce the volume of waste going to landfilling. The development of the project is not very clear, but it appears that a company called 7-Hills, in which staff of the former Thermoselect company took prominent roles, built and later operated the plant<sup>474</sup> for the waste management company Colari<sup>475</sup>, which held the regional waste management contract. The plant was planned to have three lines (two duty and one stand-by) to produce 48 MW<sub>e</sub> of which over 30 MW would emanate from the gasification plant and the remainder from a co-located anaerobic digestion plant, using a common steam bottoming cycle. However, only one of the gasification lines were installed as a first stage in 2008. However, the plant did not come into regular operation and there were public complaints and issues with the permit compliances such that the plant was temporarily closed after a few months. After restarting in late 2009, the plant was re-started, and commissioning operation was continued until to October

<sup>471</sup> Thermoselect Karlsruhe. Ein Rückbau ist nicht in Sicht. Stefan Jehle Stuttgarter-Zeitung 20. Mai 2015

<sup>472</sup> Gasification Technologies Review – Technology, Resources and Implementation. Scenarios. Prepared for the City of Sydney. Talent with Energy-TwE 2014. August 2014.

<sup>473</sup> Advanced Technology: Disparities Between Vision and Reality. HZI Client Event, Nottwil, 4 March 2016, Peter Chromec

<sup>474</sup> Malagrotta: sveliamo i misteri di gassificatore ed inceneritore chiusi. Simona Mazza. Notizie, 27 agosto 2012

<sup>475</sup> <http://www.colari.it>



2011 when the plant was closed due to operational and other issues, ending in several court cases regarding damages and non-compliance issues. In view of the difficult waste management situation in Rome there was a move<sup>476</sup> in 2016 to restart the gasifier and build the remaining gasifiers, and the public and political debate is still on-going<sup>477</sup>.

Yet another Thermoselect licensee, Interstate Waste Technologies<sup>478</sup> is marketing the Thermoselect process in North America and the Caribbean but has thus far not built any plants.

The Thermoselect HTR process consists of an initial pyrolysis stage followed by oxygen-blown high-temperature gasification in a fixed bed reactor where also melting of the inorganics and metals takes place to form a vitrified slag<sup>295, 472, 481, 482, 479</sup>. The gas is then upgraded in several stages before use as a fuel gas, for power generation in boilers or engines, alternatively as synthesis gas, Figure 86. The Thermoselect technology is claimed to accept mixed MSW and industrial waste with no material separation and minimal pre-processing requirements.

The untreated, as-received municipal solid waste is discharged directly into a storage bunker with a hold-up of several days. It is reclaimed from the waste storage by a grapple crane and dropped into feed chute of the compactor, in which the loose waste material can be pressed hydraulically to go from typically 200 kg/m<sup>3</sup> to approximately 1200 kg/m<sup>3</sup> in density by extrusion through a gate. The compaction serves as a crusher for large objects, to even out the water content, to reduce air in the waste and seal towards the process. The waste plugs formed of about 500 kg each are every 3 minutes fed one after the other into the degassing channel of the reactor, which operates at approximately 30 kPa above atmospheric pressure maintained via a water lock releasing gas to the flare if the pressure rises.

**Table 36 Waste gasifier based on the Thermoselect process<sup>472, 480, 481</sup>**

Plant	Feedstock	Year	Capacity (tpd, line * # lines)	Capacity (tpa)
<b>Thermoselect</b>				
Fondotoce, IT		1992-1999	110*1	35 000
Karlsruhe, DE	MSW	1999-2005	240*3	225 000
Ansbach, DE	MSW	Never		75 000
<b>JFE (all plants in Japan)</b>				
Chiba	MSW	1999	150*2	100 000
Mutsu	MSW	2003	70*2	45 000
Isahaya, Nagasaki	MSW	2005	100*3	100 000
Okayama,	MSW, landfill	2005	185*3	180 000
Sainokuni, Yorii	MSW, landfill	2005	225*2	150 000
Yoshino,	MSW, industrial	2005	60*2	43 500
Izumi, Osaka	MSW, landfill minings	2005	95*1	24 000
<b>WGM<sup>480</sup> or 7-Hills<sup>474</sup>Thermoselect</b>				
Malagrotta, IT	RDF	2008-2012	1*240 (planned)	75 000

<sup>476</sup> Inceneritori, quarto impianto nel Lazio e potenziamento per San Vittore. L'Inchiesta Quotidiano. 11 ottobre 2016

<sup>477</sup> Rifiuti, Robilotta (EpI): "Imbarazzante rissa tra Campidoglio e Regione" Il Quotidiano del Lazio. 08-01-2018

<sup>478</sup> www.iwtonline.com

<sup>479</sup> Thermoselect - An Advanced Field Proven High Temperature Recycling Process. H. K. Mucha, U. Drost. 6<sup>th</sup> World Congress on Integrated Resource Management, Geneva, Switzerland, February 12-15m, 2002.

<sup>480</sup> ISWA WGER Report on Advanced Thermal Treatment Processes. Status of work. 20.11.2009

<sup>481</sup> Integrated Solid Waste Management Engineering. JFE Engineering Brochure. Undated

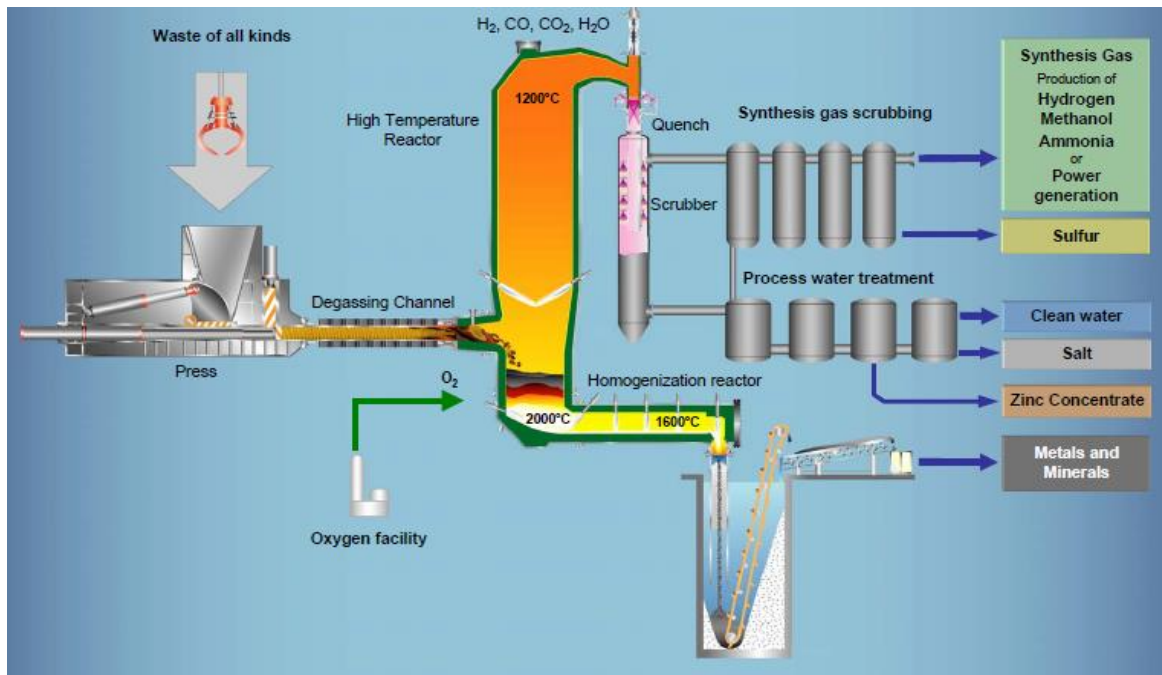

**Figure 86 The Thermoselect gasification process<sup>482</sup>**

The rectangular degassing channel is designed as a pusher kiln with slightly increasing flow area towards the high-temperature reactor. Here, drying, heating and pyrolysis of the waste bales takes place as the bales are heated on the outside, indirectly via the channel walls, and directly by the radiant heat flowing back from the high-temperature gasification chamber. The indirect heating through the channel walls is accomplished by burning part of the gas (or natural gas) and pass this in a space surrounding the gasification channel. The temperature at the end of the degassing channel is maintained at 800° C. k. The raw, wet product gas is conveyed from the degassing channel is led via a collection system to the upper sections of the high-temperature gasification chamber which is maintained at 1200 °C.

After the passage of the degassing chamber, taking typically 2 hours, the waste bales have shrunk from the loss of volatile components. The remaining solid matrix is composed of the fixed carbon, of the organic components and the inorganic portion of the waste, metals and ash, that has more or less stayed intact. When the bales have reached the end of the degassing chamber the matrix breaks apart in the transition piece to the high-temperature gasification chamber and falls into the lower section of this chamber to form a fixed bed, where oxygen is introduced. This brings the local temperature up to 2000 °C and provides the necessary conditions to melt the inorganic fraction, composed primarily of glass and various metals. The melt flows into a homogenization duct, which is heated with natural gas and oxygen and the melt separates by gravity into slag and metal before the removal of the melt into a water bath to form a mixture of a mix of mineral granulates and metal alloy pellets.

Gases released from the lower sections of the high-temperature gasification chamber flow upwards to combine with the pyrolysis gases extracted from the degassing channel. The temperature in the upper sections of the high-temperature gasification chamber is maintained at 1200 °C by oxygen addition. It is claimed that the combined action of mixing, temperature and a residence time of close to 4 s converts the most complex organic compounds and yield a high hydrogen content. The post-treatment of the gas is shown in more detail in Figure 87.

<sup>482</sup> THERMOSELECT – An Advanced Field Proven High Temperature Recycling Process. Gasification Technologies Council, Switzerland, October 12-15, 2003

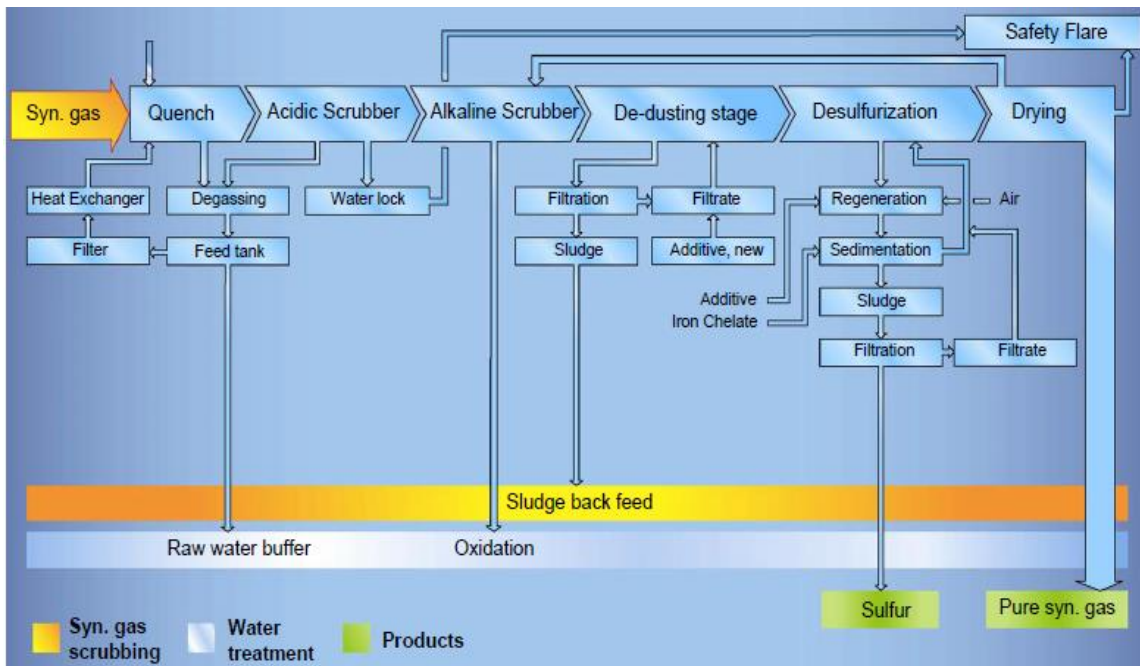

**Figure 87 The Thermoselect gas and water processing<sup>482</sup>**

The raw product gas at 1200 °C is water quenched to below 70 °C in a spray chamber and where also particulates, including heavy metals, and water-soluble acid gases such as HCl and HF are removed. Following the quench, the synthesis gas flows through an acidic scrubber where further HCl and HF acids are removed at pH~3 which also dissolve metal ions and ammonia. Downstream, an alkaline scrubber is further used to remove any slip from the acidic wash followed by a glycerine scrubber for fine dust removal. The water/glycerine/solids solution is transferred to a filter press where the solids are separated out and recycled into the high temperature reactor. Finally, H<sub>2</sub>S is removed in a liquid oxidation process, see Section 6.2.5, and ends up as elemental sulphur.

Following desulphurisation, the product gas is conditioned: the dew point of the gas is lowered by direct contact with by further cooling the gaseous stream down to 5 °C to and passing it through a wet electro-static precipitator (WESP). The gas is warmed to ambient temperature before use. The typical range of gas compositions can be found in Table 37.

**Table 37 Gas composition (dry basis) from Thermoselect plants<sup>294, 472</sup>**

Component	CH <sub>4</sub>	H <sub>2</sub>	CO	CO <sub>2</sub>	N <sub>2</sub>	Other	Energy content LCV, MJ/Nm <sup>3</sup>
Vol %	<0.1	32-35	34-39	22-27	3-4	1	7-9

The process water originates from the water in the waste and from the reaction products of the gasification process. The water treatment process occurs in batches. The water from the quench circuit is settled, solids are removed and recycled to the high temperature reactor.

The water from the alkaline scrubber, which has traces of dissolved hydrogen sulphide, is fed into vessels and oxidized using hydrogen peroxide to sulphate, while ferric iron is oxidized to ferrous iron ions. Following this, precipitation is performed at two pH levels to precipitate iron and aluminium and heavy metals, respectively, the precipitation and flocculation being enhanced by additives. The sludges are dewatered in a filter press and solids from the first stage are returned to the high temperature reactor and from the second stage processed off-site by smelters. The treated water is

neutralized and passed through ion exchanges before deionisation and can then be used as make-up water for the process or cooling towers, and since there is an excess of water it can be exported.

There is not much data from the operation of Thermosteact plants. The Karlsruhe plant had a number of process and operating problems, but also had issues with the permit, in particular regarding the use of the flare. The first plant in Japan at Chiba was tested for 15000 hours in producing fuel gas but also in a side stream gas engine validation. The technology won approval of the Japanese authorities with regard to the operating characteristics, emissions and by-products<sup>483</sup>. The plants in Japan appear to be still in operation and seems to have suffered from less technical problems. The plant in Italy appears to have suffered from similar process issues as the Karlsruhe plant, but also from mismanagement as a director of the waste company was sentenced to jail as a result of activities related to the gasifier<sup>484</sup>.

Regarding the emissions, these should in principle be able to control at the level of WID/EID as evidence by the Japanese experience and experiences from Karlsruhe<sup>485</sup> during operational periods. The drive to have low emissions and acceptable or recyclable secondary wastes and by-products however comes with a penalty in efficiency. The combination of high-temperature operation, use of oxygen, the direct quench inhibiting energy recovery from the sensible heat in the gas, pumping energy etc. all contribute to this rather low efficiency. The oxygen usage could be up to 50 % of the waste on a weight basis<sup>472</sup>, the oxygen plant contributing to the cost and to the internal power consumption. There is also a continuous support fuel consumption amounting to several percent of energy turn-over<sup>295, 472</sup>. For the Karlsruhe plant that used a backpressure steam cycle, the internal power consumption was around 20 % of the gross generation of 12.7 MW, i.e. corresponding to approximately 10 % net efficiency or some 330 kWh/ton waste. As a magnitude estimate for a case using an engine with a bottoming cycle having, say, 40 % gross efficiency, 25 MW gross could be generated from the same waste input, which would double the net efficiency and specific power generated, but still would be in line with incinerators.

#### **7.3.2.12. Other processes**

There is also a number of other developers that have developed, or are developing, waste gasification procedures that includes partial or complete gas cleaning. For some, there are no references, and the information is limited to a web page with few details.

Others have developed such solutions for "biomass" applications and where the delimitation between biomass wastes and mixed wastes are not always so clear and if the gas cleaning is also applied for projects with a waste profile. Examples of such developers is Nexterra<sup>486</sup> of Canada that have supplied some plants of presumably close-coupled combustion type in the UK, and Eqtec<sup>487</sup> of Spain and now also active in the UK<sup>488</sup> with a clear waste profile, that have references for biomass using gas engines, but were mixed waste projects in the UK also seem to use the two-stage incinerator approach.

Then, there are also companies that are developing gas cleaning for both power and synthesis gas applications and were there has lately been more opportunities on the synthesis gas side than for power generation. Two such companies are discussed under the next heading, APP, in Section 7.4.2.1 and Synova, see Section 7.4.2.5.

---

<sup>483</sup> Thermosteact Waste Gasification and Reforming Process. S. Yamada, M. Shimizu, F Miyoshi. JFE Technical Report No. 3 (July 2004)

<sup>484</sup> Rifiuti, irregolarità al gassificatore di Malagrotta: Ceroni condannato a un anno. Pena di otto mesi anche al suo collaboratore Francesco Rando. Roma 23 aprile 2014

<sup>485</sup> High Temperature Gasification- the Thermosteact Process. W. Kaiser, M. Shimuzu. Waste Management World November-December 2004, pp. 79-86.

<sup>486</sup> [www.nexterra.ca](http://www.nexterra.ca)

<sup>487</sup> <http://www.eqtec.es>

<sup>488</sup> <http://www.eqtec.es>

## 7.4. CHEMICALS AND FUELS

In this section, waste gasification technologies used to predominantly produce chemicals and fuel, respectively, are described. The separation between chemicals and fuels is somewhat misleading, as the same product, e.g. methanol can be used as both a chemical and a fuel. Also, when used as a chemical it can end up as a fuel component. Nevertheless, the motivations and economics are different and therefore it is still worthwhile to separate these applications under two headings, even if not being a strict difference in applications. In addition to what is described in the sections below, also the Schwarze Pumpe installation, see Section 7.3.2.6, was producing methanol apart from electricity.

### 7.4.1. Chemicals

#### 7.4.1.1. EBARA UBE Process EUP

Ebara Corporation and Ube Industries, an ammonia producer with experience of operating a GE (*fka* Texaco) coal gasification synthesis gas plant, in collaboration with the Plastic Waste Management Institute initiated a development on plastic waste gasification in 1998, including tests in a pilot plant<sup>489</sup>. The development was sponsored by NEDO because of its relation to the Container and Packaging Recycling Law coming into force in Japan in 1997. After conducting successful trials in a 10000 tonnes/year demonstration plant in 2000 and the two companies established a 50/50 joint venture, EUP Co. Ltd. in Ube to exploit the technology. The plant went into commercial operation in year 2001 generating synthesis gas which is sold to Ube Ammonia Industry Ltd. for use as in ammonia production. At the same site, an additional plant of 20000 tonnes/year started operation in 2003<sup>490</sup>. The construction of an additional installation with 2 x 98 tonnes/day capacity or 60 000 tonnes/year was also announced.

In 2004, Showa Denko K.K. (SDK) announced that the company had started commercial production of ammonia in its plant in Kawasaki using waste plastic (used containers and wrapping for consumer products, and industrial wastes). The ammonia is sold as a liquid under a newly registered product brand name, ECOANN, and is primarily used for de-NO<sub>x</sub> applications in power plants. The plant has a total capacity to process 195 tons per day, 60 000 tonnes/year, of collected waste plastic produce 175 tons, 55 000 tonnes/year, of liquid ammonia and other chemical products. The cost of the project was 8.4 billion ¥ (80 million \$US in 2004) of which 44 % was covered by subsidies from the Government and Kawasaki City<sup>491</sup>. In 2012, the volume of ammonia produced at the recycling plant accounts for about one third of the total annual output of 100 000-120 000 tonnes at the Kawasaki Plant<sup>492</sup>, see Figure 88. (These numbers may refer to the ECOANN production only as the total ammonia capacity from the Kawasaki plant is 1 500 000 tonnes per year or some 500 tonnes per day<sup>493</sup>).

Ube Industries bought the shares of Ebara Corporation in 2007 and later consolidated it into the mother company. However, due to a scarcity of waste plastics due to market changes favouring pelletizing of waste for usage as a co-firing fuel, this led to the closure of the EUP facilities at UBE 2008 and completely withdraw from the waste plastics gasification business in 2010<sup>494</sup>.

<sup>489</sup> Ube Industries and Ebara Corporation's Two-Stage Pressure Gasification System Wins Leading Science and Technology Award from Japanese Government. UBE News, April 20, 2005

<sup>490</sup> EBARA's Fluidized Bed Gasification: Atmospheric 2 x 225 t/d for Shredding Residues Recycling and Two-stage Pressurized 30 t/d for Ammonia Synthesis from Waste Plastics. Christian Steiner, O. Kameda, T. Oshita, T. Sato. The 2nd International Symposium on Feedstock Recycling of Plastics Oostende, Belgium, 9. Sept. 2002

<sup>491</sup> SDK Starts Commercial Production of Ammonia Using Waste Plastic. SDK News release May 7, 2004

<sup>492</sup> Spotlight on Kawasaki. Published in Nature, September 20, 2012

<sup>493</sup> Showa Denko Boosts High-purity Ammonia Production in Taiwan. Showa Denko News release December 22, 2015

<sup>494</sup> Ube Withdraws from Ebara-Ube Process Recycling Business UBE News, May 7, 2010

In 2015, Showa Denko announced that it had expanded the plant to process more plastic waste, reaching up to 65 % of the ammonia output in the plant, and that the expansion was partially financed by a loan from the Japanese government<sup>495</sup>. No absolute capacity numbers have been found, but it is likely that it effectively means that the capacity has doubled.



**Figure 88 The Showa Denko waste plastics plant<sup>496</sup>**

The EUP two-stage pressure gasification system<sup>489, 490, 497</sup>, see Figure 89, converts unsorted waste plastic, being baled at the recycling facility and then further prepared by shredding and pelletisation, into a synthesis gas. A typical composition of the waste plastics feed is shown in Table 38

**Table 38 Typical composition of plastic waste feed to the Show Denko plant<sup>497</sup>. (LHV estimated by the author)**

Constituent	C	H	O	N	Cl	S	Metal	Ash/Slag	Est. LHV MJ/kg
% by weight	74.2	10.7	6.3	0.4	2.5	0.1	2.9	2.9	36

The process takes place in a two-stage gasifier comprised of a low temperature gasifier and a high temperature gasifier, both operating under a pressure of 1 MPa. The low temperature gasifier is a fluidized bed using the Ebara Twin-Rec gasifier as a model for its design. It is operated at 600-800 °C using oxygen and steam as fluidizing media. The bottom design allows the separation of any remaining metal in the waste plastic, which is removed at the bottom of the gasifier and sent for recycling. The gas generated goes to the high temperature gasifier, an entrained flow, slagging, reactor where the gas undergoes thermal decomposition and partial oxidation at 1300- 1500 °C by injection of additional steam and oxygen. The reactor has an internal cooling and a slag bath at the bottom. This high temperature causes melting of solids carried over from the low temperature gasifier, and which are separated and solidified as the gas passes through the slag bath before leaving the reactor and are recovered as granulated slag for use as a raw material in cement and

<sup>495</sup> Showa Denko Expands Utilization of Used Plastic to Produce Ammonia. SDK News release July 1, 2015

<sup>496</sup> Experience of Incinerator Development in Japan. Katsuya Kawamoto. Seminar on thermal treatment of MSW in Hong Kong. Environmental Department of Hong Kong, March 7, 2008.

other construction materials. It is claimed that the gas after the high temperature gasifier has almost no trace of hydrocarbons.

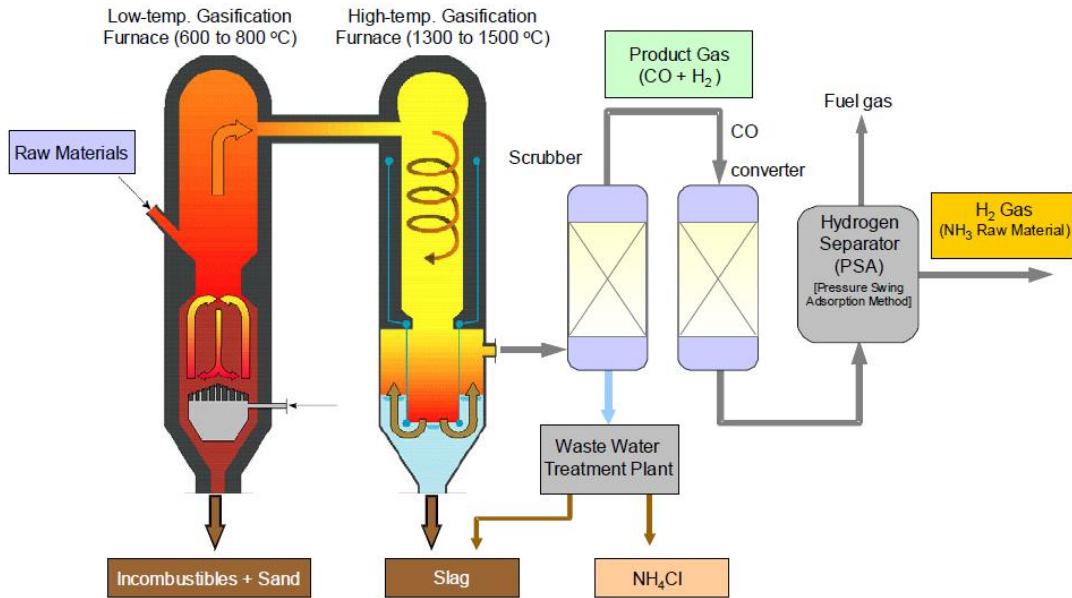

**Figure 89 THE EUP process<sup>490</sup>**

The gas is then washed in a scrubber where remaining solids, HCl and ammonia are removed (Figure 90).

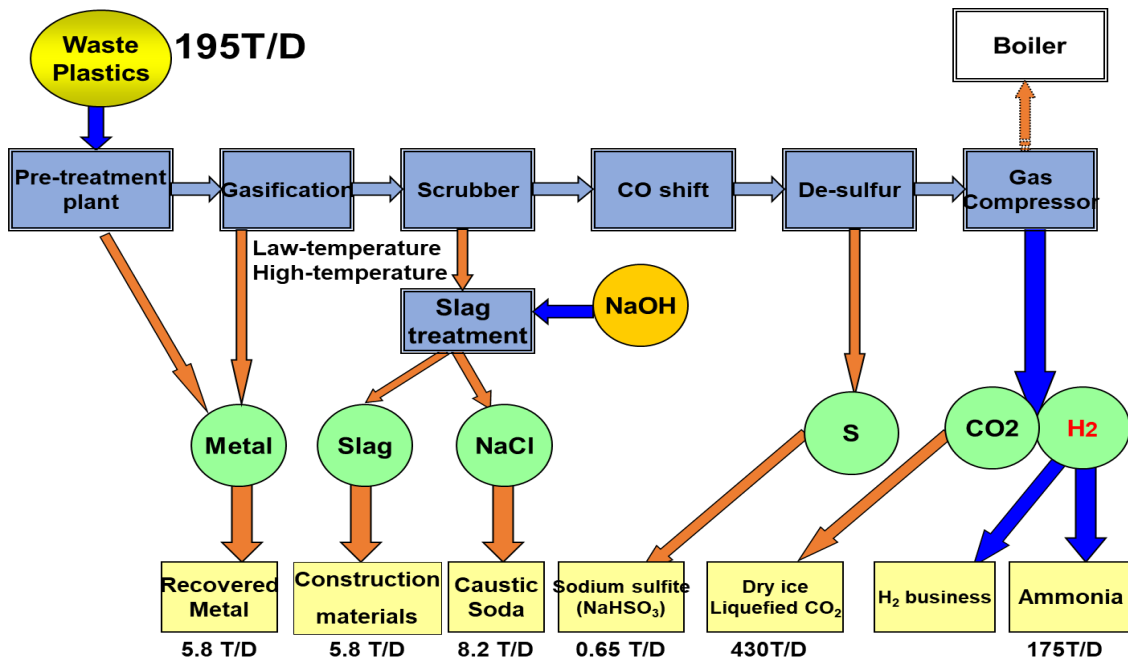

**Figure 90 Material stream from the Showa Denko plant (before expansion in 2015)<sup>497</sup>**

<sup>497</sup> The Best Practice on the Reduction of Plastic Waste. Development of New Recycling System for Used Plastics. Kazuyuki Hirabayashi. Showa Denko K.K. 2005.

Following the scrubbing, the gas passes a water gas shift CO conversion step to increase the hydrogen yield. Following this step, and not shown in the figure, is sulphur removal by an alkaline solution prior to compression and separation of hydrogen in a PSA unit. The hydrogen, 346 000 Nm<sup>3</sup>/day (14 400 Nm<sup>3</sup>/h) is fed to the ammonia plant but can also be sold as merchant hydrogen. Also, other materials are recovered from the by-product streams, Figure 90. Apart from metals and granulates, the chloride is used to produce caustic soda, sulphur removed is used to produce sodium bisulphite and CO<sub>2</sub> is recovered and used for dry ice production. Tail gases are burned.

## 7.4.2. Fuels

### 7.4.2.1. APP (Advanced Plasma Power Ltd.)<sup>498</sup>

Tetronics<sup>499</sup> (derived from tetra+ionics) was established 1964 in the UK to exploit the potential of DC plasma arc technology in various industries. The company was acquired by InvestSelect in 2004, which triggered significant investment and development of the strategy to new areas of applications. Today, Tetronics supplies DC plasma arc systems for applications such as waste recovery, hazardous waste treatment, industrial waste treatment, metal recovery, production processes and nano-materials. The company has developed and maintains an extensive patent portfolio and has built more than 80 plasma installations worldwide<sup>500</sup>.

In November 2005, InvestSelect's principal investors set up Advanced Plasma Power Limited ("APP") to commercialise the Gasplasma<sup>®</sup> energy-from-waste process, now with patent coverage in some fifty countries, originally developed by Tetronics. The process treats various forms of wastes to an energy-rich product gas (syngas) and a solid, vitrified product from the non-combustible components. APP is developing its own projects (on a design, build, finance and operate basis) as the exclusive licensee of Tetronics' Gasplasma technology. The company has also secured significant investment from US private equity fund Leveraged Green Energy in 2009 and 2011<sup>501</sup>.

As of 2005 APP operated a pilot plant of unknown capacity to validate the Plasmagas concept. In 2008 a demonstration plant with a capacity of 100 kg/h, 600 kW fuel feed, and also including a gas engine, was taken into operation. This plant has been operated for over 2500 hours up to 2017<sup>502</sup> and has generated a number of publications on this experience<sup>503, 504, 505, 506, 507, 508</sup>. For commercial installations, APP has a relationship with Outotec, see Section 7.3.1.4, as a preferred supplier of the fluidized bed gasifier component.

In 2013, APP was together with Syntech Bioenergy, see Section 7.3.2.9, and Synova (Royal Dahlman), see Section 7.4.2.5, respectively, selected<sup>509</sup> in a competition arranged by the Energy Technology Institute<sup>510</sup> to lead a consortium to design cost-effective, economically viable and

---

<sup>498</sup> advancedplasmawater.com

<sup>499</sup> Tetronic.com

<sup>500</sup> <http://is-uk.biz/investments/>

<sup>501</sup> <https://www.letsrecycle.com/news/latest-news/plasma-firm-secures-further-funding-support/>

<sup>502</sup> BioSNG Demonstration Plant. Summary of Plant Design. GoGreenGas, 31 March 2017

<sup>503</sup> Two stage fluid bed-plasma gasification process for solid waste valorisation: Technical review and preliminary thermodynamic modelling of sulphur emissions. S. Morrin, P. Lettieri, C. Chapman, L. Mazzei, Waste Management 32 (2012), pp. 676–684

<sup>504</sup> Technical Aspects and Thermodynamic Evaluation of a Two Stage Fluid Bed-Plasma Process for Solid Waste Gasification. M. Materazzi, P. Lettieri, L. Mazzei, R. Taylor, C. Chapman. The 14th International Conference on Fluidization – From Fundamentals to Products. Delft University of Technology N.G. Deen, Eindhoven University of Technology Eds, ECI Symposium Series, (2013).

<sup>505</sup> Thermodynamic modelling and evaluation of a two-stage thermal process for waste gasification. M. Materazzi, P. Lettieri, L. Mazzei, R. Taylor, C. Chapman. Fuel 108 (2013), pp. 356–369

<sup>506</sup> Transformations of Syngas Derived from Landfilled Wastes Using the Gasplasma<sup>®</sup> Process. Richard Taylor, Chris Chapman, Ahmad Faraz. 2nd International Academic Symposium on Enhanced Landfill Mining, Houthalen-Helchteren, Belgium, 14-16 October 2013

<sup>507</sup> The fate of ashes and inorganics in a two-stage fluid particle system for waste valorization. M. Materazzi, P. Lettieri, R. Taylor, C. Chapman. The 7th World Congress on Particle Technology (WCPT7). Procedia Engineering 102 (2015), pp. 936 – 944

<sup>508</sup> Performance analysis of RDF gasification in a two-stage fluidized bed-plasma process. M. Materazzi, P. Lettieri, R. Taylor, C. Chapman. Waste Management, Volume 47, Part B, January 2016, pp 256-266

<sup>509</sup> APP shortlisted by the ETI in competition to design most efficient energy from waste demonstrator plant. APP press Release, April 8th, 2013

<sup>510</sup> [www.eti.co.uk](http://www.eti.co.uk)



efficient commercial energy from waste demonstrator plant. The criteria were to target a commercial scale of between 5 to 20 MW<sub>e</sub> output and to have a net electrical efficiency of at least 25%. The winning plant, to be selected in 2014, could be designed, built, tested and in operation by 2015 or 2016.

The consortium led by APP was funded by 2.8 million GBP to design a demonstration facility with an electrical output of 6MW<sub>e</sub> using the Gasplasma® technology in a so-called CP20 module. The site for this project was Tyseley, Birmingham, where land was leased for a first phase of 60000 tonnes per year, 7 MW<sub>e</sub> facility, with expansion possibilities to 130000 tonnes per year. The plant had received planning permission, environmental permit and ROC pre-accreditation<sup>511</sup>. The permit decision document<sup>512</sup> describes the planned installation as a 50000 tonnes/year facility that after a recycling operation produces 35 000 tonnes/year RDF, equivalent of a 20 MW thermal input to the gasification plant. The plant was designed to produce 6.6 MW<sub>e</sub> gross from two 3 MW<sub>e</sub> output engines and a 0.6 MW<sub>e</sub> ORC unit. The net output to the grid was 4.2 MW<sub>e</sub>, translating into 900 kW<sub>e</sub>/tonne of RDF. Of the internal consumption of 2.4 MW<sub>e</sub>, the gasification process would use 0.7 MW<sub>e</sub> while the recycling facility, and utilities use the remainder. This project was not completed, and the permit was surrendered in 2015.

In 2014, APP announced that it signed a contract as the technology provider for a new waste to energy plant in the Port of Hamilton, Ontario, Canada, at a value of nearly £20 million. The plant, a so-called GP 60 module, would process 170000 tonnes of waste annually while delivering 20 MW<sub>e</sub> to the grid<sup>513</sup>. However, the project was subject to approval of the permit and has since also come across local opposition and is no longer active<sup>514</sup>.

In 2012, a waste to bio-methane project was announced as a cooperation between Cadence (*fka* National Grid), Advanced Plasma Power and Progressive Energy<sup>515</sup>, later to be named GoGreenGas<sup>516</sup>. The objective was to demonstrate the use of waste by means of plasma gasification to produce bio-methane. The project budget was 4.2 million GBP received funding from the Ofgem Innovation Funding Incentive<sup>517</sup>. The project<sup>518</sup> would use the existing Gasplasma demonstration plant in Swindon and extend it to use the synthesis gas to produce SNG (Synthetic Natural Gas) at a capacity of approximately 50 kW thermal and meeting the specification for injecting it into the gas network. The synthesis gas would be produced and, after compression stored and used for SNG production using the AMEC Foster Wheeler once-through VESTA process<sup>519</sup>. The project was completed in 2017.

Already in 2015, it was decided to go further into a first commercial plant<sup>520</sup>. The facility is an integrated end to end process, with a capacity of 10000 tonnes/year, 22 GWh/year (or 4.4 MW) bio-methane output, constructed at Advanced Plasma Power's premises in Swindon. Refuse derived fuel will be supplied from local wastes and the gas produced will be injected into the Wales and West Utilities' gas network for use in local homes and in an existing CNG filling station. APP and its partners Cadence, Progressive Energy and CNG Services received 11 million GBP in funding from Department for Transport as part of a program to develop and commercialize the technologies

<sup>511</sup> Converting waste into valuable resources with the Gasplasma® Process. Chris Chapman, IEA Bioenergy Task 36 Workshop, 29th October 2014

<sup>512</sup> Permit number EPR/UP3231NQ. Tyseley Urban Waste Resource Centre Ltd. Decision Document. Environment Agency, 24 April 2014

<sup>513</sup> APP news release, 9th June 2014.

<sup>514</sup> Port authority cuts ties with Port Fuels, proposed gasification plant is dead. Kelly Bennett. CBC News Jun 23, 2017

<sup>515</sup> National Grid, Advanced Plasma Power and Progressive Energy announce new project to transform waste into Bio Substitute Natural Gas. APP Press Release. Wednesday, February 22nd, 2012

<sup>516</sup> gogreengas.com

<sup>517</sup> <http://www.smartnetworks.org/project/nggdgn01>

<sup>518</sup> BioSNG Demonstration Plant. Project Close-Down Report. GoGreenGas 2017

<sup>519</sup> The Novel VESTA Process for Substitute Natural Gas Production. Fabio Ruggeri. Gasification Technologies Conference 2012 Washington, DC, USA

<sup>520</sup> Government Grant Awarded to Fuel UK Towards Sustainable Future. APP Press Release, September 7th, 201

required to decarbonize the transport sector, the Transport Advanced Biofuels Competition. Additional funding towards the adjusted project budget of 27 million GBP (up from 25 million GBP) is provided by 5 million GBP is provided by Ofgem’s Network Innovation Competition and the partners, of which Cadent is the largest contributor with 8.6 million GBP<sup>521</sup>. The plant is in the final stages of mechanical completion and is expected to be commissioned in late 2018.

In 2018, APP was selected by Velocys<sup>522</sup> as the preferred gasification technology provider for a project to produce sustainable aviation fuel from waste. Velocys and its partners are currently developing the engineering and business case for the project and it is expected that a final investment decision will be reached in the first half of 2020<sup>523</sup>. The project, is being developed with the support of industry partners, including BA and Shell Aviation, and the Department for Transport which have together provided 4.9 million GBP of funding<sup>524</sup>.

The Gasplasma process<sup>504, 512</sup>, Figure 91, can accept a wide variety of feedstocks such as biomass and wastes. The typical feed considered is RDF, prepared off-site or on-site. The typical pre-treatment is removal of fines, removal of ferrous and other metals and shredding to <50 mm size. From the RDF storage, the RDF is retrieved and dried in a belt drier with steam/air batteries providing the energy. The steam uses energy recovered from the Gasplasma process. The wet exhaust air is treated in a bag filter and a thermal oxidizer to remove odours before its release to the atmosphere.

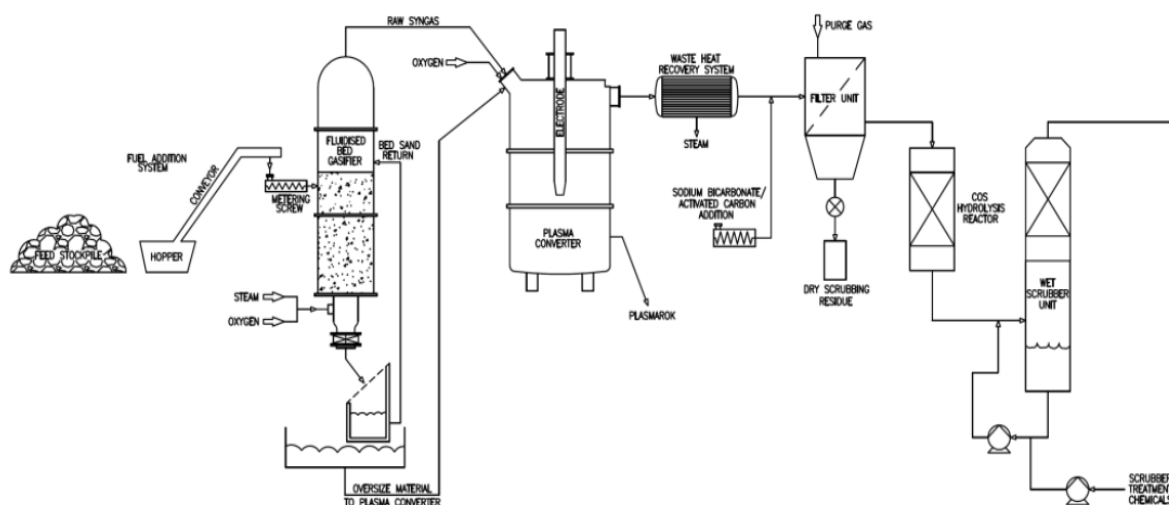

**Figure 91 The Gasplasma process and associated gas cleaning (adapted from<sup>518</sup>)**

The RDF plus any fines removed in the RDF preparation stage (on-site preparation case) are fed with the dried RDF stream into the stationary fluidized bed gasifier (as noted above, Outotec is the preferred supplier of this component) together with steam and oxygen fluidizing gas. This process provides sufficient heat to maintain the fluidised bed between 700 and 850 °C and produces a “crude” product gas.

The crude syngas contains significant quantities of long-chain hydrocarbons and tars. The ash in the RDF is automatically removed from the base of the gasifier through the bed screening process and conveyed to a hopper where it is metered into the plasma converter, and bed material separated is

<sup>521</sup> Cadent-backed trailblazing trash-gas project wins 2017 Energy-Institute award. GoGreenGas Press Release 10 November 2017. [www.velocys.com](http://www.velocys.com)

<sup>523</sup> Advanced Plasma Power’s Gasplasma® technology selected for pioneering UK waste-to-jet-fuel project. APP, June 20, 2018

<sup>524</sup> Development funding secured for next stage of UK project. Velocys news release, June 18, 2018.

recycled to the gasifier such that there is no bottom ash secondary material removed at this stage of the process.

The crude product gas is transferred from the gasifier to the plasma converter where it enters on the side of the converter chamber above the slag level in such a way that the gas flows in circulating motion around the periphery of the chamber. In the centre of the plasma converter there is a graphite electrode that can be moved and even replaced during operation. A plasma arc is generated between the tip of the electrode and the molten slag bath contained in the converter hearth. To reduce the power consumption for the plasma, also oxygen is introduced to the converter. The gas increases in temperature and is exposed to an intense ultra violet which results in that hydrocarbons are cracked and reformed that residual char is converted.

The converter is also designed to capture the particulate materials entrained in the gas flow from the gasifier and convert these into slag which builds up in a "pool" at the bottom of the plasma converter. This molten material is continuously removed from the plasma converter via an overflow weir and cooled for use as a vitrified and stable material. This material has been accepted as a product following an End of Waste Submission and is trademarked under the name "Plasmarok®" for use as aggregate in construction<sup>525</sup>.

The processed product gas is then drawn to the inlet of the gas cooling system, a heat recovery boiler that reduces the gas temperatures from the outlet temperature of the converter of approximately 1200 °C to 160 °C while generating saturated steam, typically at 1 MPa for use in the RDF dryer.

The dry gas cleaning system, operating at 150°C to 180°C, consists of a ceramic particulate filter into which the sodium bicarbonate and activated carbon are injected into the product gas to capture acidic components, any traces of heavy hydrocarbons and volatile metals. The filter cake is periodically removed using a nitrogen reverse pulse system. After the dry gas cleaning, there is a wet gas cleaning train. For power generation application<sup>512</sup> (and slightly different compared to the synthesis gas application shown in Figure 91), the gas is cooled to about 35 °C in a condenser scrubber at a low pH such that it absorbs ammonia. This is followed by a second, alkaline, scrubber to absorb acid gases, in particular sulphur dioxide and hydrogen sulphide. The effluent from this scrubber and the condensate from the condenser scrubber are discharged from the system for treatment as an effluent. NaClO is used to oxidise sulphides in the condensate.

The syngas leaving the wet cleaning system is clean syngas ready for use in power generation by means of gas engines. The exhaust gases from the engines pass through a system of emissions control catalysts to ensure that the emissions comply with the IED. Heat can also be recovered from the engine exhaust system by an ORC cycle to generate electricity.

For the application of making SNG by the VESTA process<sup>526</sup>, there is a COS hydrolysis reactor added downstream the filter<sup>518</sup> to reduce the COS in the gas, as shown in Figure 91. This is followed by the wet cleaning as described above. The gas is then compressed to 1.3 MPa, before a further carbon bed removes residual condensable hydrocarbons and heavy metals, and a zinc oxide guard bed provides final removal of sulphur compounds. After further polishing of the syngas to remove catalyst poisons, a water gas shift reactor with a by-pass is used to obtain the correct ratio of hydrogen to carbon monoxide. Four sequential adiabatic methanation reactors in series converts the synthesis gas to bio-methane, followed by cooling and steam condensation. An activated carbonate wash methane purification stage is used for the removal of CO<sub>2</sub> to ensure that the bio-methane

---

<sup>525</sup> Explained: Plasmarok®, Generated from Waste Recovery. Teclonics International Ltd., 2015.

<sup>526</sup> Decision document. Permit Number: EPR/JP3336RM. Go Green Fuels Limited. Environmental Agency, 25/07/2016

complies with the specifications for use in transport, as well as for grid export. The removed CO<sub>2</sub> is compressed and stored in tanks for transport off site and use as an industrial gas. For direct supply as bio-CNG transport fuel the bio-methane is compressed to 25 MPa and stored in a tube trailer. For export to the local grid, the gas is spiked with propane as required to meet the LCV and Wobbe Index requirements of the grid.

The GoGreenGas consortium has also made several studies of future commercial plants for production of bio-methane and hydrogen. Two bio-methane facilities were assessed<sup>527,528</sup> converting 136 000 tonnes of waste per year (66 MW thermal) into 42 MW, 315 GWh/year and a plant converting 289 000 tonnes of waste per year (132 MW thermal) to 84 MW, 665GWh of bio-methane. The investment costs and annual operating costs were estimated to 108 and 11 million GBP and 151 and million GBP for the small and large case, respectively.

In a separate but linked study<sup>529</sup>, conceptual engineering and cost estimation for a 100000 tonnes waste per year, 62 MW thermal (HHV), that produces 45 MW (HHV) hydrogen has been developed. The processing is similar to the one described for methane with the exception that several shift reactors are used in series to convert all CO, and that the remaining CO is removed by methanation. Following the CO<sub>2</sub> wash, the hydrogen reaches the desired purity using a PSA unit. The plant capital cost and annual operating cost was estimated to 99 million GBP and 19 million GBP/year, respectively. Further pertinent details on these studies can be found in the cited references.

#### **7.4.2.2. Enerkem<sup>530</sup>**

The development of the process commercialized by Enerkem Inc. goes back to the 1980s<sup>531</sup>, when BIOSYN Inc., a subsidiary of Nouveler Inc., a division of Hydro-Quebec (Montréal, Quebec) developed an air- or oxygen-blown bubbling fluidised bed gasifier in a bench-scale unit 50 kg/h and between 1984 and 1988 in a 10 tonnes/hr plant at St-Juste de Bretennières, Québec, Canada, operating up to 1.6 MPa to produce synthesis gas for methanol production. In 1988 the development was stopped due to market conditions. Professor E. Chornet at the University of Sherbrooke, Quebec, Canada was involved in this development in the early 1980s<sup>532</sup> and the experience led to the development of a core technology which links a fluid bed reactor with advanced gas conditioning s to provide a clean synthetic gas. The spin-off company Enerkem was founded in the year 2000. The Chornet family is still a major stakeholder and some members also have operative positions in the company.

In 2003, a 4.8 tonnes/day pilot plant gasifier was built in Sherbrooke, which served as a basis for a scale-up to a complete demonstration facility at Westbury in 2007. The plant has a capacity of 48 tonnes/day of feed input. It can produce 11 tonnes/day methanol since 2011, and by further reactions between methanol and synthesis gas, ethanol since 2012. The plant had almost 13000 logged operating hours in 2016<sup>533</sup>.

Enerkem also built a 25 000 tonnes/year full-scale plant in Castellon, Spain. Since 2003 the plant has converted mixed industrial plastic waste into gas which is combusted in reciprocating engines<sup>534</sup>

<sup>527</sup> BioSNG Demonstration Plant. Summary of Commercial Results. GoGreenGas, 2017

<sup>528</sup> BioSNG Demonstration Plant. Summary of Plant Design. GoGreenGas, 2017

<sup>529</sup> Biohydrogen: Production of hydrogen by gasification of waste. Progressive Energy and Advanced Plasma Power, July 2017.

<sup>530</sup> www.enerkem.com

<sup>531</sup> Biomass Gasification for Hydrogen Production – Process Description and Research Needs. IEA Bioenergy Update. S. Babu. Biomass & Bioenergy, undated.

<sup>532</sup> Gasification of Residual Biomass via the Biosyn Fluidized Bed Technology. Czernik, S & G. Koeberle, P & Jollez, Paul & Bilodeau, Jean-François & Chornet, Esteban. (1993). Advances in Thermochemical Biomass Conversion, ed. Anthony Bridgwater, 2004

<sup>533</sup> Building Up the Future. Technology status and reliability of the value chains

Sub Group on Advanced Biofuels Sustainable Transport Forum. Edited by: Kyriakos Maniatis, Ingvar Landålv, Lars Waldheim, Eric van den Heuvel, Stamatis Kalligeros. March – 2017

<sup>534</sup> Gasification I Cogeneration Using MSW Residuals and Biomass, Jim Schubert, Konrad Fichtner. 13th North American Waste to Energy Conference, May 23-25, 2005, Orlando, Florida USA. NAWTEC13-3154

to give a total of 7 MWe. However, the plant owner/operator, Poligas Ambiente SL went into receivership in 2004<sup>535</sup>, but appear to have been revived and to have tried to operate the plant until 2009 when the permit was withdrawn followed by a bankruptcy<sup>536</sup>.

In 2009, as the demonstration plant was in commissioning, an SPV, Alberta Enerkem Greenfield Biofuels, was developing a commercial prototype project in Edmonton, Alberta, to a stage where a permit was received by the province authorities<sup>537</sup>. The project company was composed of Enerkem and Greenfield Ethanol, an established ethanol producer. The project planned to convert 100 000 tonnes per year of RDF into 38 million litres of ethanol. In parallel, a project of double the Edmonton capacity based on two Edmonton modules was being developed in Pontotoc, Mississippi, USA, at a cost of 250 million \$US<sup>538</sup>. Eventually, a smaller project equal in capacity to the Edmonton plant, received a grant support to the US Enerkem daughter from DOE of 50 million \$US<sup>539</sup>. The cost for this plant, including initial operation, was 140 million \$US<sup>540</sup>

In 2010, both the city of Edmonton and the Alberta province provided grant funding of a total of 23 million \$CA<sup>541</sup> and the construction of the plant started. The city of Edmonton was also constructing a waste recycling facility to supply the RDF to the plant. The same year, Waste Management made an investment of 54 million \$CA in Enerkem. Also, the Pontotoc project advanced by receiving the permits required.

In 2011, this was followed by 60 million \$CA invested by the refiner Valero to a total of 90 million \$CA for the mother company, while also 15 million \$CA was raised for as project equity financing for the Edmonton plant<sup>542</sup>. The same year, the Pontotoc project in the USA was awarded an 80 million \$US loan guarantee for the project<sup>539</sup>.

In 2012, a new project was announced<sup>543</sup>, a project of similar capacity as the Edmonton project at Varennes, Quebec. The project is developed by a SPV, Vanerco, composed of Enerkem and Greenfield Ethanol, the latter already operates a corn-based ethanol plant at Varennes. The project received a grant of 18 million \$CA and loan of 9 million \$CA, respectively, from the provincial government and a reimbursable support of 40 million \$CA from the NextGen Biofuels Fund of Sustainable Development Technology Canada<sup>544</sup>. The same year, Enerkem announced a 125 million \$US Initial Public Offering (IPO) to finance project plans, but the IPO was withdrawn<sup>545</sup>, motivated by the fact that the company could raise funds directly from investors and was not mature for the stock market. In the SEC F-1 filing<sup>546</sup>, it is stated that the Edmonton project at the time was estimated an initial construction costs to build the plant for methanol production of approximately 80 million \$CA, plus finance costs. The second stage, to go from methanol to ethanol was estimated to approximately 25 million \$CA, plus finance costs. It was also noted that the Enerkem ownership of the facility was reduced to approximately 70 % as a result of equity capital injections of Waste Management and EB Investments ULC. The installation cost of the Pontotoc project in the USA was

---

<sup>535</sup> Status of Gasification in countries participating in the IEA and GasNet activity. K. Kwant, H. Knoef. IEA Bioenergy /GasNet, August 2004

<sup>536</sup> [www.europapress.es/comunitat-valenciana/noticia-castellon-poligas-invierte-cuatro-millones-euros-planta-gasificacion-ribesalbes-20070925152257.html](http://www.europapress.es/comunitat-valenciana/noticia-castellon-poligas-invierte-cuatro-millones-euros-planta-gasificacion-ribesalbes-20070925152257.html), [www.elmundo.es/elmundo/2008/05/30/valencia/1212174173.html](http://www.elmundo.es/elmundo/2008/05/30/valencia/1212174173.html), [www.levante-emv.com/castello/2009/10/15/ribesalbes-cierra-poligono-poligas-empresas-residuos/641650.html](http://www.levante-emv.com/castello/2009/10/15/ribesalbes-cierra-poligono-poligas-empresas-residuos/641650.html), Boletín Oficial del Registro Mercantil, Núm. 151, Pág. 27981. Lunes 9 de agosto de 2010

<sup>537</sup> <https://www.newswire.ca/news-releases/enerkem-greenfield-alberta-biofuels-awarded-permit-to-build-worlds-first-commercial-municipal-waste-to-biofuels-facility-537757731.html>

<sup>538</sup> Enerkem Planning Biofuel Project in Mississippi. Renewable Energy World March 20, 2009

<sup>539</sup> Enerkem News release, January 20, 2011

<sup>540</sup> US Department of Energy Pontotoc, MS Project. Final Scientific Report. Enerkem Inc. 15/03/2015

<sup>541</sup> Enerkem biofuel plant, backed by City of Edmonton, mired in legal controversy. Sylvain Bascaron, CBC News Mar 28, 2016.

<sup>542</sup> Enerkem News release July 28, 2011

<sup>543</sup> Enerkem News release, February 6, 2012.

<sup>544</sup> 2017 Interim Evaluation of the NextGen Biofuels Fund Sustainable Development Technology Canada. Kelly Sears Consulting Group, November 30, 2017

<sup>545</sup> Enerkem IPO comes up short. Shawn McCarthy. The Globe and Mail. Published May 2, 2012

<sup>546</sup> [https://www.sec.gov/Archives/edgar/data/1528521/000104746912002855/a2207407zf-1a.htm#eo10701\\_principal\\_shareholders](https://www.sec.gov/Archives/edgar/data/1528521/000104746912002855/a2207407zf-1a.htm#eo10701_principal_shareholders)

estimated to 90-100 million \$CA, a cost that did not include the waste recycling centre to be built by third parties.

In 2013, an additional 37 million \$CA in equity for the Edmonton plant project was received and later the mother company raised another 50 million \$CA for the mother company financing from Investissement Québec and others. The commissioning of the plant was started in 2013.

In 2014, a new SPV, Enerkem Alberta Biofuels, was set up as the owner and operator of the plant, which was officially inaugurated in June. The NextGen Biofuels Fund of Sustainable Development Technology Canada provided complementary reimbursable funding of 64 million \$CA to the Edmonton project, which at this point is prioritized by Enerkem over the Vanerco project<sup>544</sup>. Discussions are initiated for follow up projects in Europe.

In 2015 the Edmonton plant started to produce methanol. Yet another 150 million \$ CA is raised in financing for Enerkem, partially as debt and partially as private placement<sup>547</sup>. The production of ethanol was initiated in 2017 after the plant had been complemented with the methanol-to-ethanol production step in 2016. This second stage was supported by 3.5 million \$CA from Western Innovation<sup>548</sup> while it was noted that the support from the NextGen Biofuels Fund was instrumental in realizing the second step, i.e. the methanol to ethanol conversion step, without further delays<sup>544</sup>. During the period from 2015 to 2017, the plant outputs had been certified as advanced biofuels in Europe and as "cellulosic ethanol" within the RFS2 system in the USA.

In the period 2015 to 2017, the Pontotoc and Vanerco projects lost the loan guarantee and the support from NextGen Biofuels Fund, respectively, as in neither case the construction has been initiated within the due allocation period for the funds. However, the Vanerco projects is still being pursued by the partners while the Pontotoc project fades out from the flow of biofuel news.

In 2018, Enerkem Inc. has signed an agreement with Chinese Sinobioway Group worth over 125 million \$ CA in the form of equity investment in the company and future revenues from license, equipment as well as form a joint venture with the prospects of constructing over 100 Enerkem-based plants in China by 2035<sup>549</sup>, raised yet another 155 million \$ CA from existing investors and from the asset management company Black Rock.

The activities in Europe also became more concrete. A project development was initiated for Rotterdam by a consortium of companies comprising Air Liquide, AkzoNobel Specialty Chemicals, Enerkem and the Port of Rotterdam. This 250 million € plant would process 360 000 tonnes of waste per year and produce 220 000 tonnes of methanol per year<sup>550</sup>. A second development was announced in Tarragona, Spain<sup>551</sup> in cooperation with Suez. The plant, estimated to a cost of 250 million €, is expected to process 375 000 tonnes of waste per year and produce 265 000 tonnes of methanol. When comparing yield of methanol per ton of waste and recalculating the 38000 m<sup>3</sup>/year ethanol yield of the Edmonton plant to methanol, this would be approximately 42 000 tonnes/year or 0.42 tonnes/tonne of RDF. The cited projects in the EU have a yield of 0.6 and 0.7 tonnes methanol/tonne waste, respectively. This difference would indicate that either the feedstock is significantly different than the RDF used in Edmonton, notably has a far higher energy content, or that there is some other element in addition to the gasification facility that contributes to the methanol production.

---

<sup>547</sup> Enerkem News release, September 9, 2015.

<sup>548</sup> Enerkem Alberta receives C\$3.5 million federal grant for Edmonton plant. Biofuels Digest November 21, 2017.

<sup>549</sup> Enerkem News release, January 22, 2018.

<sup>550</sup> Enerkem News release, February 16, 2018.

<sup>551</sup> Advanced biofuel plant planned to open in 2022. Catalan News, May 9, 2018

The Enerkem process process<sup>530, 552, 553</sup>, see Figure 92, is comprised of four stages: feed preparation, gasification, gas cleaning and the synthesis of biofuels (or use of the gas for e.g. power production). The integrated process has been developed by Enerkem and is seen as proprietary know-how, so in-depth details of the process are not generally publicly available.

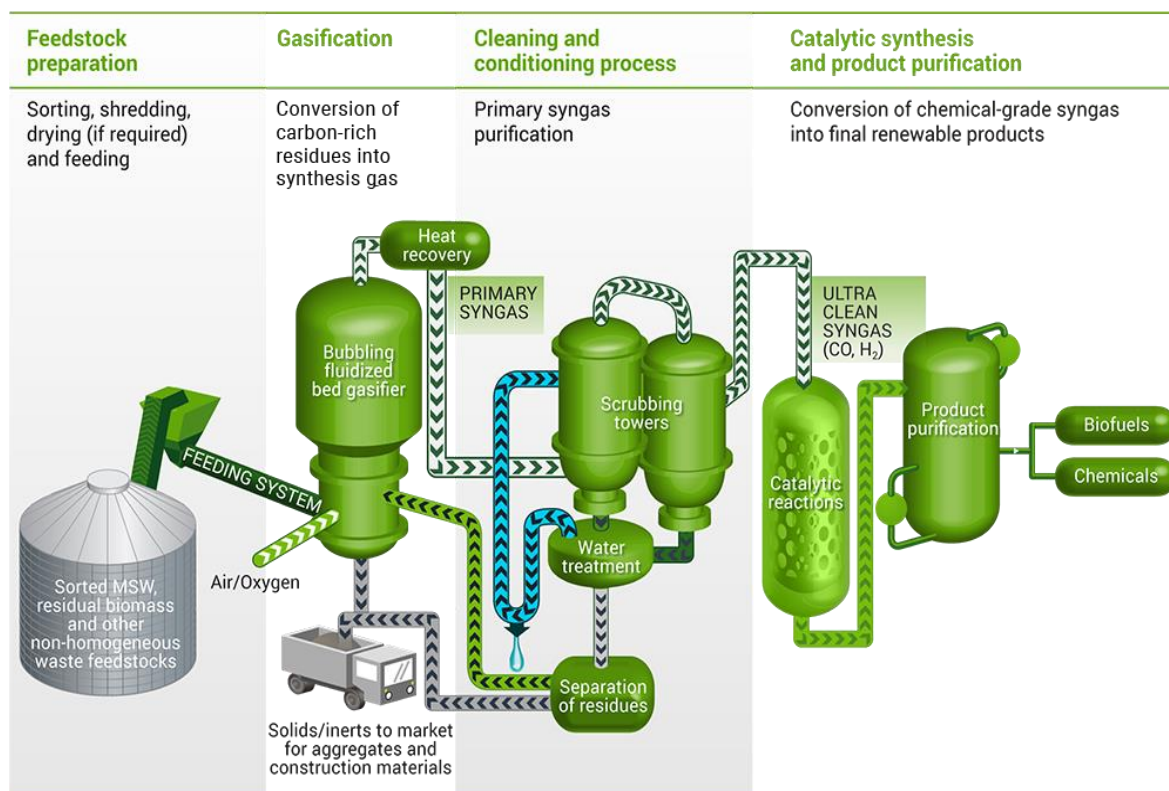

\* Municipal solid waste

**Figure 92 The Enerkem technology<sup>530</sup>**

The waste material is pre-treated in order to obtain a feedstock with a characteristic particle size of about 50 mm as a typical dimension and a bulk density of at least 150 kg/m<sup>3</sup> and in most cases it is dried using residual process heat. The feedstock, prepared to the specification, is fed to the gasifier via a feeding system that pressurize the feed to the gasification pressure of below 0.2-0.4 MPa<sup>533</sup> and controls the rate of material extracted to a water-cooled transfer screw, that injects the material into the fluidized bed section of the gasifier where an appropriate fluidizing media is maintained.

The fluidized bed contains a not specified bed material, and fluidizing gas (air, O<sub>2</sub> enriched air, steam/O<sub>2</sub> or steam/O<sub>2</sub>/CO<sub>2</sub>), is injected through a distributor grid located at the bottom of the fluid bed at a rate to maintain the bed temperature. The fluidized bed has high mixing and heat transfer rates which facilitate the reactions taking place during gasification. The temperature in the fluid bed part of the reactor is kept at about 700°C. The feedstock thermally decomposes producing volatiles, gases and char particles. The latter stay in the fluidized bed and is reacted by partial oxidation and gasification until they are small enough to be entrained from the bed by the fluidizing gases to the freeboard. In the Enerkem process, the temperature is increased in the freeboard (and possibly also in a separate vessel downstream of the gasifier although this is not shown above) by staged

<sup>552</sup> From biomass-rich residues into fuels and green chemicals via gasification and catalytic synthesis. S. C. Marie-Rose, E. Chornet, D. Lynch & J.-M. Lavoie. WIT Transactions on State of the Art in Science and Engineering, Vol 83, 2014 WIT Press 2014, pp.91-100  
<sup>553</sup> US 2010/0051875 A1

addition of controlled amounts of oxidant. This exposes the volatiles and the entrained particles to partial oxidation, thermal cracking and steam- as well as CO<sub>2</sub>-driven reactions. The gasifier is designed as a steel shell with internal refractory insulation. In the Edmonton plant, the gasifier shaft has an internal diameter of 3.1 m<sup>546</sup> and holds 20 tonnes of sand bed material<sup>554</sup>.

After separation of the larger solid particulates using cyclones, which are extracted out of the process the and gas cooling by heat recovery, the gas cleaning follows. A two-stage scrubbing system with pH-adjustment is used that recovers the tar and re-injects it into the gasifier for additional syngas production. The condensate formed from cooling the gas is separated from tar in settlers, stripped from ammonia, which is also reinjected into the gasifier, and treated by conventional means before being discarded. A main part of the sulphur is dissolved as H<sub>2</sub>S in the process condensate and is discharged as sulphate in the treated effluent<sup>555</sup>. Adsorbents such as lime and ZnO can also be used to remove remaining traces of chloride and sulphur.

The cleaned gas is then compressed to an intermediate pressure and subjected to additional conditioning. The clean syngas will still contain low molecular weight hydrocarbons whose concentration depends on the nature of the feedstock which may require an additional reforming step. Also, the H<sub>2</sub>/CO-ratio may require adjustment by a water gas shift reactor to come just above 2, which is suitable for the methanol synthesis. The gas is then treated by chilled methanol to remove CO<sub>2</sub> in a proprietary design scrubbing process<sup>556</sup>. After CO<sub>2</sub> removal, the gas is compressed to the synthesis pressure and methanol is synthesized in a proprietary three-phase process<sup>557</sup>. The chemical synthesis reaction,  $\text{CO} + 2\text{H}_2 \rightarrow \text{CH}_3\text{OH}$ , is carried out in a bubble-column slurry reactor using a Cu/ZnO/Al<sub>2</sub>O<sub>3</sub> catalyst at temperature ranging from 230 to 260 °C and 1 to 5 MPa. The commercial reactor operates with fine catalyst particles that are slurried in an inert high-boiling oil, typically white mineral oil. The gaseous reactants dissolve in the oil and react on the catalyst particle surfaces. The methanol and water formed are separated from the oil and distilled to arrive at high-purity methanol product.

However, in the Edmonton plant, Enerkem uses the methanol as an intermediate to produce ethanol by carbonylation to methyl acetate, also in a proprietary process<sup>558</sup>. This is carried out using a fixed bed packed with a rhodium-based catalyst. To the methanol methyl iodide is added as a co-catalyst at a molar ratio between 1 and 5 wt.%. The mixture is vaporized under pressure and mixed with a CO-rich fraction of synthesis gas prior to flowing through the reactor. The operating conditions are 170 to 300°C and total pressures from 1 to 5 MPa.

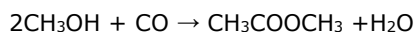

The methyl acetate produced is separated as a liquid at 20 °C. It is pumped to a pressure ranging from 1 to 5 MPa through a heat exchanger that vaporizes it at temperatures ranging from 150 to 225 °C and mixed with preheated hydrogen before the mixture passes through a catalytic bed containing a CuO/Cr<sub>2</sub>O<sub>3</sub> or CuO/ZnO/Al<sub>2</sub>O<sub>3</sub> catalyst and is converted to ethanol and methanol. The ethanol product is separated from the methanol and the latter is recycled back to the carbonylation step.

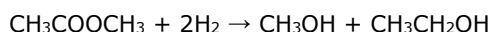

<sup>554</sup> Five minutes from trash to ethanol: Edmonton's long-delayed Enerkem plant explained. Elise Stolte. Edmonton Journal, February 19, 2018

<sup>555</sup> Personal communication, Michel Chornet, Enerkem, 2017.

<sup>556</sup> Authors note: this being somewhat similar to the Rectisol process

<sup>557</sup> Conversion of Non-Homogeneous Biomass to Ultraclean Syngas and Catalytic Conversion to Ethanol. Stéphane C. Marie-Rose, Alexis Lemieux Perinet and Jean-Michel Lavoie. Biofuel's Engineering Process Technology. Ed. Marco Aurelio Dos Santos Bernardes. InTech Open, 2011 Pp. 334-352.

<sup>558</sup> US 8,080,693 B2



The Edmonton plant<sup>559</sup>, Figure 93, located in Edmonton, Alberta, Canada, represents the result of the city's development for over a decade to improve the waste management based on the knowledge that the landfill would be closing, and the alternative would be hauling waste out of the city at higher costs. The city had also already established recycling and composting programs that had succeeded in diverting 60 % of the waste from landfills. The city had formulated specific targets to increase Edmonton's landfill diversion rate from 60 % to 90 % and also reduce the need for landfilling without the use of conventional incinerator technologies. In 2003 the city examined the options which led to establishing a cooperation with Enerkem, which at the time was making pilot plant tests. The cooperation led to R&D projects funded by Alberta Energy Research Institute that validated the performance at pilot scale with pelletized RDF and later an RDF fluff feeding system was designed and tests continued. In 2006, a grant from Alberta Innovates allowed further project development, and the project was then also officially announced.



**Figure 93 The Enerkem Alberta Biofuels plant<sup>560</sup> in Edmonton, Alberta**

In 2007 and 2008 the contractual framework was developed, and environmental permitting was initiated. The permit was received in 2019. The project, at the time estimated to cost 70 million \$CA planned to convert 100 000 tonnes per year of RDF (daily consumption of 300 tonnes dry, or 350 tonnes wet RDF<sup>561</sup>) into 38 million litres of ethanol<sup>537</sup> went into construction in 2010. In parallel the city of Edmonton was building a waste recycling facility, integrated processing and transfer facility at a cost of 90 million \$CA, of which the section for the supply the RDF to the Enerkem plant was included at an estimated cost of 40 million \$CA. The city would provide the RDF for the plant against a gate fee for a contract period of 25 years<sup>541</sup>. In 2012, and as was noted above the initial construction costs to build the plant for methanol production was estimated to a total of 105 million \$CA, plus finance costs, to go to methanol first, and then secondly go all the way to ethanol<sup>546, 559</sup>.

<sup>559</sup> The Edmonton Waste-to-Biofuels Project. From Research to Reality. Jim Schubert. RCA Conference, October 2, 2014

<sup>560</sup> Courtesy of Enerkem.

<sup>561</sup> Enerkem filling orders in Alberta. Edmonton Waste-to-biofuels facility in full operation Andrew Snook. Canadian Biomass, November 22, 2016

The initial plan was to be operational in 2012<sup>554</sup>, but due to various delays the commissioning did not start until 2013 and the inauguration took place in mid-2014. In late 2016, it was reported that the plant had accumulated some 2600 hours of operation<sup>533</sup>. There was a second delay, since the installation of the methanol-to-ethanol step was not installed until 2017. According to Enerkem, the reason for this was that as a support to the development of the projects in Europe, this time was used to demonstrate methanol production in the facility. However, there may also be other reasons for the delay, as contractors were making claims on Enerkem at the time<sup>562</sup>. There were also changes being made to the process system and inquiries were made for a combustion system to convert the tars removed from the syngas<sup>412</sup>. An RDF drier was installed in the recycling facility in 2017 to increase heating value of RDF supplied to Enerkem<sup>563</sup>. There were also inquiries for a combustion system to convert the tars removed from the syngas<sup>412</sup>. It is also known that the plant has not come up to full capacity<sup>564</sup>, which is at least partially related to the RDF quality<sup>565</sup>. The target for 2018 is to ramp up the operations to reach to the nameplate ethanol capacity by the end of the year<sup>566</sup>.

The total cost of the plant up to 2016 has not been disclosed by Enerkem but it has been publicly quoted by a non-Enerkem source to amount to 120 million \$CA<sup>567</sup> in 2016. Public reporting from NextGen Biofuels Fund of Sustainable Development Technology Canada<sup>568</sup> states that the "total project value" is 175 million \$CA; however, it is not clear if this only represents the accumulated plant installation overnight costs or if financing and e.g. commissioning and initial operation costs are also included.

In addition to the Integrated Processing and Transfer Facility, the overall plan of the city also includes a 12.5 million \$CA Advanced Energy Research Facility to develop and demonstrate innovative technologies converting residual biomass or waste feedstock into clean energy and products, based on primarily Enerkem technologies, which was inaugurated in 2013. The facility holds a 300 kg/h pilot gasification facility and can also support R&D in various bench and laboratory scale gas cleaning and related technologies<sup>559</sup>.

#### **7.4.2.3. Ineos Bio**

INEOS<sup>569</sup> is a 20-year old global manufacturer of petrochemicals, speciality chemicals and oil products that has been formed from thirty-four different established chemical companies. The turnover is 60 billion \$US. In the early years of this century it was large producer of technical ethanol. Through its refining activities the company also gradually become engaged in biofuels production, primarily FAME biodiesel but also ethanol.

In 2008, INEOS Bio was formed and acquired the IPR of Bioengineering Resources Inc. (BRI) in Fayetteville, AR, USA<sup>570</sup> with the intent of also moving into cellulosic ethanol to deploy the technology globally as an owner-operator and partnerships combined with licensing. To further leverage on the company strength, the technology could be extended to chemicals and polymers<sup>571</sup>.

BRI, which was founded in 1984, had since 1989 developed gasification and fermentation technologies for production of ethanol or acetic acid from solid wastes<sup>572</sup>. The synthesis gas

<sup>562</sup> Enerkem biofuel plant, backed by City of Edmonton, mired in legal controversy. Sylvain Bascaron. CBC News Mar 28, 2016

<sup>563</sup> [www.stela.de/en/company/stela\\_news/rd-drying-in-edmonton-canada\\_j52eqd2a.html](http://www.stela.de/en/company/stela_news/rd-drying-in-edmonton-canada_j52eqd2a.html)

<sup>564</sup> Edmonton's broken-down Cadillac waste management system. Graham Hick. Edmonton Sun, March 16, 2018

<sup>565</sup> Edmonton Councillor Michael Ward. Blog post February 9, 2018.

<sup>566</sup> Personal communication Marie-Hélène Labrie, Enerkem, June 2018

<sup>567</sup> Atwell R.: "Task force's work on waste management left out of plan", 27-09-2016, Saanich News and Black Press Group Ltd, <https://www.saanichnews.com/opinion/task-forces-work-on-waste-management-left-out-of-plan/>

<sup>568</sup> SDTC Success Story. Company Name: Enerkem Alberta Biofuels LP. Project Name: Enerkem Alberta Biofuels Project

<sup>569</sup> [www.ineos.com/](http://www.ineos.com/)

<sup>570</sup> <http://www.greencarcongress.com/2008/07/ineos-bio-to-co.html>

<sup>571</sup> INEOS Bio Commercialization of Cellulosic Biofuels from Waste. Mark Dietzen. FEW Conference, St. Louis, MO, June 11, 2013

<sup>572</sup> <http://www.bioenergyresourcesllc.com>

fermentation to ethanol had been developed since 1991. The ethanol pilot plant was started in based on bottled gas and in 2003 a 1.3 tonnes/day gasifier was added to provide the synthesis gas<sup>573, 574, 575</sup>. The development has been partially funded via DOE support of 4.8 million \$US<sup>576</sup>. The gasifier selected, CONSUMAT, and integrated into the pilot plant was designed by Consutech Systems, LLC, Richmond, VA, USA<sup>577</sup>. After the acquisition of the assets, BRI changed name to Bioethanol Holdings, Inc. which in 2014 was closed and Bioenergy Resources, LLC was re-initiated.

To demonstrate the gasification- syngas fermentation route to ethanol ("cellulosic ethanol" under the RFS2 system in the USA), INEOS Bio and New Planet Energy Florida<sup>578</sup>, whose main responsibility lies in the front-end waste handling, formed a joint venture company called INEOS New Planet BioEnergy (INPB) in 2009 for the purpose to construct and operate the first industrial installation using the BRI technology at Vero Beach, FL, USA<sup>579</sup>. The facility was designed to consume 90 000 tonnes/year of waste (270 dry tonnes/day), consisting of MSW and yard waste. The plant output was 30 000 m<sup>3</sup>/year of fuel-grade bioethanol and 6MW of electrical power, with some 2MW exported to the electrical grid.

The estimated cost was 121 million \$US. INPB applied for and was awarded a 50 million \$US Department of Energy ("DOE") grant in 2009 to for the construction of the demonstration plant, commissioning and initial operation into 2014 at a budget of 132 million \$ US. In addition, INPB received a USDA loan guarantee of 75 million \$US, a grant from the state of Florida 2.5 million \$US plus reductions on property taxes worth 0.8 million \$US<sup>580</sup>.

The construction of the Indian River BioEnergy Center in Vero Beach, FL, see Figure 94, started in February 2011 and mechanical completion was reached in June 2012 at budget, the RFS II registration was finalized in August 2011 while the first power was generated in the third quarter of 2012. The cellulosic ethanol production while the first ethanol was produced in the second quarter of 2013<sup>571</sup> and the first RINs<sup>581</sup> (14 000) were registered in January 2014<sup>582</sup>.

However, the commissioning was prolonged due to issues which are further discussed below, and operations were suspended in December 2013. In particular, there was an issue with HCN in the gas that affected the microorganisms producing ethanol. In September 2014, a major turn-around had been completed that included upgrades to the technology also involving additional testing in the pilot plant, including cyanide mitigation measures and the annual safety inspections and that operations would be resumed. However, again in December 2014, the plant operation was suspended<sup>583</sup>. In 2016, INEOS announced its intent to sell its cellulosic ethanol business, including the plant in Vero Beach, FL, and the R&D in Fayetteville, AR, via a bid process after spending more than eight years and 300 million \$US in development costs. The reason for the divestment was stated to be that the U.S. market for ethanol had changed and that the economic drivers for the technology were no longer aligned with the company's strategic objectives<sup>584</sup>.

---

<sup>573</sup> Advanced bioethanol production from ligno-cellulose, residues and waste materials. Graham Rice. Energy Institute. London, 18th April 2011.

<sup>574</sup> <http://bioconversion.blogspot.com/2006/01/la-council-visits-bri-energy.html>

<sup>575</sup> [http://www.greencarcongress.com/2005/06/coproduction\\_of.html](http://www.greencarcongress.com/2005/06/coproduction_of.html)

<sup>576</sup> [www.tcpalm.com/story/news/2017/01/17/ineos-closes-vero-beach-biofuel-plant/96412616/](http://www.tcpalm.com/story/news/2017/01/17/ineos-closes-vero-beach-biofuel-plant/96412616/)

<sup>577</sup> [www.consutech.com](http://www.consutech.com)

<sup>578</sup> <http://newplanetenergy.com>

<sup>579</sup> Recovery Act- INP Bioenergy Indian River County Facility. Final Scientific Report. Grant DE-EE0002882.001 Mark Niederschulte.

INEOS New Planet BioEnergy LLC. US DEPARTMENT OF ENERGY FEDERAL ASSISTANCE PROGRAM 22 July 2016

<sup>580</sup> [eu.tcpalm.com/story/money/business/2016/09/02/ineos-bio-selling-indian-river-county-biofuel-plant/89823970/](http://eu.tcpalm.com/story/money/business/2016/09/02/ineos-bio-selling-indian-river-county-biofuel-plant/89823970/)

<sup>581</sup> Renewable Identification Number, i.e. an identification number for a biofuel that can be used to show compliance with the RFS2 quota obligation and as such also is a tradeable asset supporting the production of different types of biofuels.

<sup>582</sup> INEOS Bio: Biofuels Digest's 2015 5-Minute Guide. Jim Lane, February 17, 2015

<sup>583</sup> INEOS New Planet BioEnergy. Indian River BioEnergy Center. Kelly Russell. 2015 DOE IBR Platform Peer Review, March 24, 2015

<sup>584</sup> INEOS Bio to sell ethanol business, including Vero Beach plant. Erin Voegelé. Biomass Magazine September 07, 2016

Following this decision, the technology was sold to a Chinese company, Jungpeng Bio in June 2017<sup>585</sup>, and the site was sold in September 2018 to an unrelated company from Texas<sup>586</sup>.

A second project was planned at Seal Sands, Teesside, UK with a capacity of 24 000 tonnes per year and 7 MW<sub>e</sub> gross that had received 7.3 million GBP in support from UK government sources. The planning consent had been given and the project could be initiated when a financial closure could be reached<sup>573</sup>, however, the developments in the Vero Beach plant were not conducive to such a development.



**Figure 94 The INEOS Bio New Planet Indian River BioEnergy Center<sup>587</sup>**

A simplified flowsheet is shown in Figure 95. The waste and biomass come to the plant, are dried and gasified. The gas is cooled and cleaned prior to passing the syngas fermentation unit where the CO and H<sub>2</sub> is converted to ethanol. The ethanol is concentrated by distillation and dehydrated before being shipped. The heat recovered, and any surplus gases are combusted and drives a steam turbine generating power.

Taking a closer look, Figure 96, there plant is more complicated<sup>588, 589, 590</sup>. Trucks will deliver woody waste and clean woody construction debris to the tipping floor of the materials handling area. The materials handling area will include equipment for storage, handling, grinding and screening of the feedstock. The facility will store all MSW in the enclosed feedstock building holding a maximum of two days storage.

<sup>585</sup> <http://www.jupengbio.com/blog/jupeng-bio-has-acquired-ineos-bio-for-the-manufacture-of-biofuels-from> 2017

<sup>586</sup> Former INEOS Bio site purchased for conversion into eco-district. Erin Voegelé. Biomass Magazine, February 21, 2018

<sup>587</sup> INEOS New Planet BioEnergy Indian River BioEnergy Center. Kelly Russell. 2015 DOE IBR Platform Peer Review, March 24, 2015

<sup>588</sup> Technical Evaluation & Preliminary Determination Indian River County Bioenergy Facility. Arms Facility Id No. 0610096 Draft Permit No. 0610096-001-Ac Permitting Authority. Florida Department of Environmental Protection Division of Air Resource Management. Tallahassee, Florida, July 30, 2010

<sup>589</sup> Technical Evaluation & Preliminary Determination Indian River County Bioenergy Facility. Arms Facility Id No. 0610096 Draft Permit No. 0610096-002-Ac Permitting Authority. Florida Department of Environmental Protection Division of Air Resource Management. Tallahassee, Florida, August 31, 2011

<sup>590</sup> INEOS Bio Process Technology Brochure. Undated.

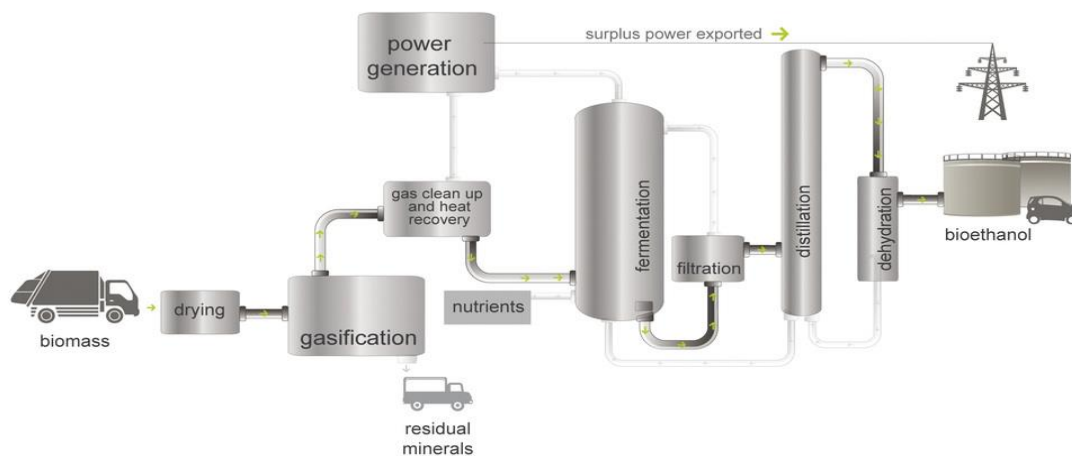

**Figure 95 The INEOS Bio process simplified flowsheet<sup>591</sup>**

The two feedstock dryers will receive shredded feedstock from the storage piles and use low-pressure steam, provided by the boiler and heat recovery systems, to reduce the feedstock moisture to around 15 %.

Two gasifiers will convert the shredded input feedstock to syngas through a two-stage process. First, a dedicated ram feeder pushes dried feedstock into the lower gasification zone. During start-up, natural gas will be introduced into the lower zone burner to bring the system up to speed, but once steady operation is achieved, only additional oxygen will need to be supplied. There will be no vent from the gasifier, other than emergency pressure relief through diversion to the gasifier flare.

The CONSUMAT<sup>®</sup> modular controlled air incinerator/gasifier, Figure 97, utilizes two chambers for the incineration process, the primary, lower, refractory-lined combustion chamber, which is loaded with the fuel feedstock. Sub-stoichiometric air or oxygen/steam is supplied to the combustion chamber from beneath. The fuel undergoes pyrolysis and generates volatiles and gases. Non-combustible materials such as metal, glass and carbonaceous residue remain on the bottom of the lower chamber where the pushing action of the feeder transfer solids in the step-formed bottom of the primary chamber towards the ash outlet meeting the oxidant. The result is a sterile, oxidized ash product.

The primary chamber gas and vapor products pass into a secondary chamber, which is mounted immediately above the main combustion chamber. Additional oxidant is injected into this chamber where the tars and other hydrocarbons are thermally decomposed at high temperatures, above 1100 °C<sup>574</sup> to synthesis gas (CO and H<sub>2</sub>). The operation of each chamber is controlled independently. The gasifier operates at a slight underpressure to avoid fugitive emissions.

Following gasification, the product gas is cleaned and cooled through several steps. First, two parallel heat recovery systems cool the syngas while preheating the boiler feed water. The two streams of cooled product gas then pass through dry gas clean-up, where sodium bicarbonate (originally lime but changed in 2011) and activated carbon injection will remove halogens, metals, tars and ammonia. Fabric filters will recover the spent lime and carbon, and the filtered gas is routed to a quench tower for additional cooling. The cool, dry, clean syngas will then be ready for introduction to the fermentation system.

<sup>591</sup> Biomass Gasification in the United States. Country Report for IEA Bioenergy Task 33. Kevin Whitty, Elena Shanin, Spencer Owen. The University of Utah, Salt Lake City, UT, USA, 30 September 2015

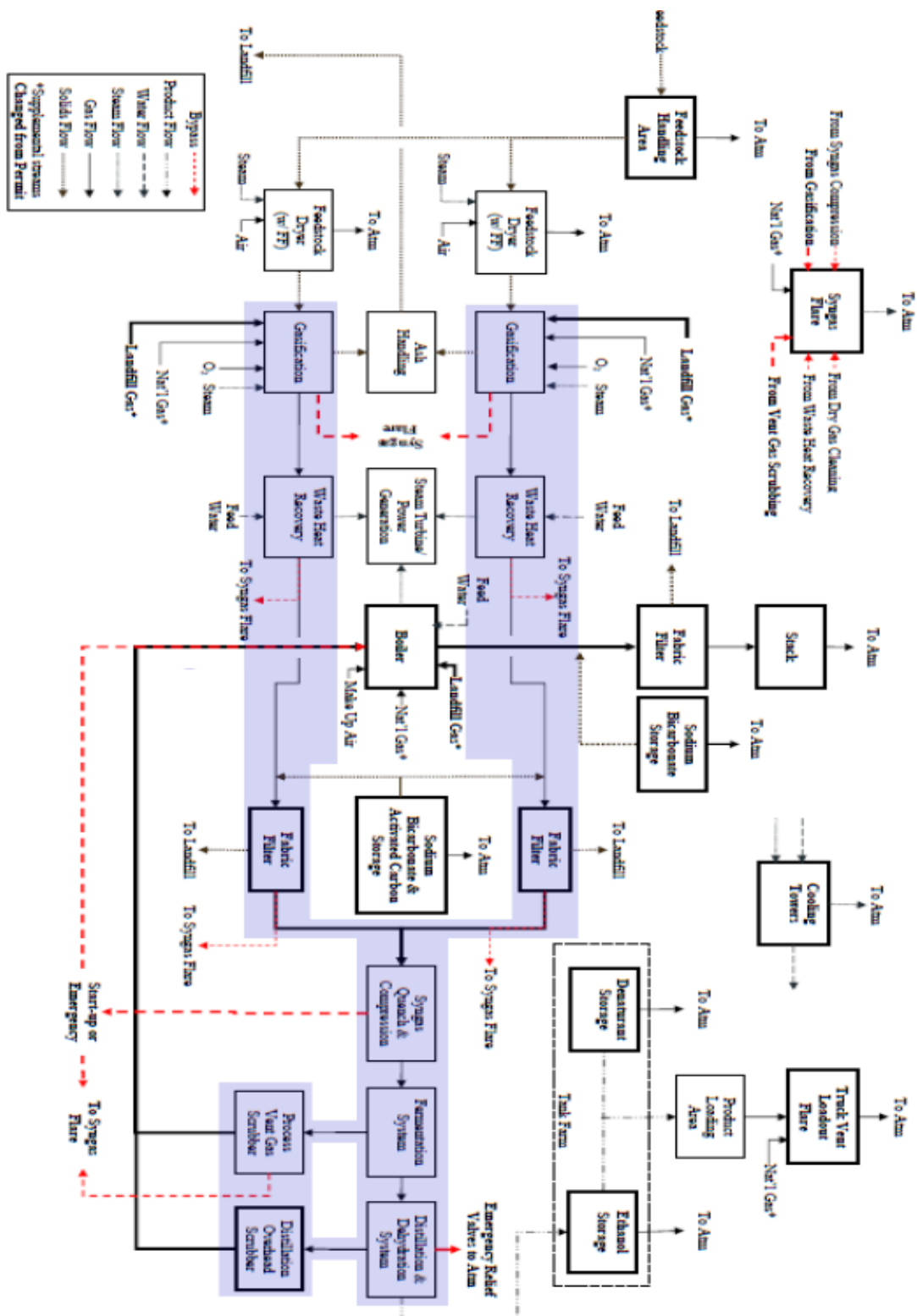

**Figure 96 The INBP plant block diagram (Adapted from<sup>589</sup>)**

The syngas is introduced into the patented fermentation process, which takes place at low temperature and pressure using naturally occurring anaerobic bacteria with tolerance to variations in syngas composition and to common poisons. In the fermenter, which is agitated to enhance gas-liquid transfer, dissolved gases are consumed to selectively produce bioethanol within a few minutes

of residence time. Also, nutrients are added to provide for cell growth and automatic regeneration of the biocatalyst. The bioethanol is synthesized according to the following principal reactions:

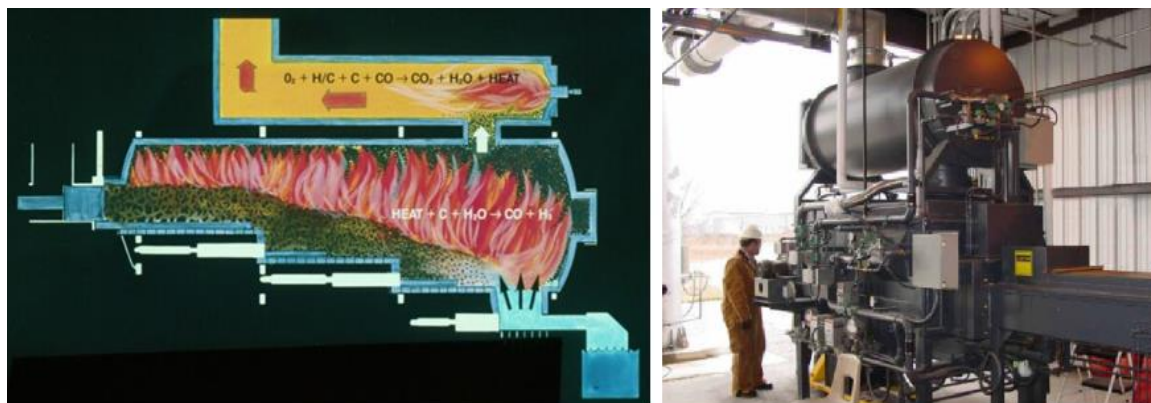
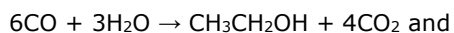

**Figure 97 The Comsumat gasifier<sup>577</sup> and the 1.5 tpd pilot unit<sup>573</sup>**

Most of the syngas is converted to bioethanol. The unconverted syngas (vent gas) is cleaned in a scrubber and is together with other gaseous streams combusted in a 15 MW thermal boiler to generate steam. The steam will be used in the gasifiers, the feedstock dryers, and a steam turbine to produce electricity. The electricity will power the plant, with some additional generation to be commercially sold on the electric grid. Originally, a LOX sulphur removal system was foreseen prior to combustion, but this was later replaced by a post-combustion system using sodium bicarbonate and another filter. There are two flares, for the gasifier and for synthesis gas as emergency backup during malfunctions of shorter duration.

The fermenter broth and vent gas scrubber bottoms are continuously extracted, filtered to remove the bacteria and nutrients and distilled. The distillation tower will receive the broth (a mixture of water, ethanol, acetic acid and heavy alcohols) from the distillation feed tank, and overhead vapor leaving the distillation tower will be collected in a reflux drum and pumped back into the tower. Water from the distillation column is recycled back to the fermenter. Water purge from distillation is treated in a waste water treatment facility. The hydrous ethanol is then purified by molecular sieve to anhydrous bio-ethanol that are sent to a set of tanks prior to loading on tanker trucks.

Operational issues encountered<sup>579</sup> have been "more than expected grid failures" that required the plant to shut-down, and then enter into a lengthy restart process. A back-up generation system with automatic start was installed. Also, the fuel moisture content of the fuel was higher than design.

The gasifier has suffered from some mechanical failures. In the gasification system ingress of air increased the nitrogen content of the gas, and additional measures for sealing of equipment was required. Also, slag formation has been experienced in the gasifier. Furthermore, the gasifiers did not reach full capacity due to an overpressure problem solved with additional fans to transfer gas to the gas cleaning section.

There has also been corrosion in the gas cleaning section requiring changes in material. The humid climate of Florida has also impacted on the feeding of gas cleaning agents.

In the fermenter, the operating pressure was reduced to increase the productivity. However, the biggest issue has been the HCN content of the gas, about 15 ppm<sup>582</sup>, which has poisonous effects on

the microbiology. To solve this, a set of three towers were installed, to absorb HCN from the gas down to below 1 ppm, to strip the HCN with air, and to capture the HCN from the air into water, respectively. Finally, sodium hypochlorite is used to oxidize the HCN prior to discharge of the water.

The revised permit in 2011<sup>589</sup> allowed the use of MSW in trial runs up to 365 ton/day, and thereafter regular use up to 110 % of the feed rate where compliance testing had been approved. However, RDF trials were scheduled for 2016, so it appears that the plant never operated on RDF<sup>579</sup>.

Despite the corrective actions, it appears that the operations were not overly successful, and INEOS Bio has now sold this business. However, both before the take-over of BRI and afterwards, there was an ambition to build-up an IPR portfolio, evidenced by a number of patents filed on the various parts of the system.

#### **7.4.2.4. Fulcrum Bioenergy<sup>592</sup> and Thermochemical Recovery Inc. (TRI)<sup>593</sup>**

Fulcrum Bioenergy was founded in 2007 in Delaware by capital firms US Renewables Group and Rustic Canyon Partners, but has its offices in Pleasanton, California<sup>594</sup>. The purpose was to develop a reliable and efficient process for the conversion of MSW into a renewable transportation fuel based on a proprietary thermochemical process. The founders injected 39 million \$US up to 2008.

In 2008<sup>595</sup>, the development rights were acquired for the Sierra project from InEnTec LLC and a Master Purchase and License Agreement was agreed with InEnTec of Richland, Washington, for the gasification system technology. Also, a Development Agreement was signed with Nipawin Biomass Ethanol New Generation Co-operative Ltd. and Saskatchewan Research Council to access a catalyst for incorporation into a proprietary process for converting syngas into ethanol. The Nipawin/SRC catalyst is very similar to a hydrotreating catalyst used in almost every refinery in the world. The catalyst contains no precious or rare earth metals and can be recycled by the catalyst manufacturer. Since 2009 this process was validated at Turning Point Ethanol Demonstration Plant utilizing a full-scale reactor tube identical to those that will be used at Sierra. Until 2011, the demonstration plant has logged more than 8000 hours. The technology is claimed to allow production of 0.27 m<sup>3</sup> of ethanol per ton of MSW.

The same year Fulcrum Sierra Biofuels LLC was formed as an SPV for a biorefinery project in Storey County, Nevada, and with Fulcrum as a 90 % owner. In the period up to 2011, there was also a focus on securing long-term, zero-cost MSW feedstock agreements with solid waste companies to provide a reliable stream of MSW for Sierra Biofuels. In addition, also MSW agreements for future projects in 19 states for up to 20 years to produce had been negotiated, enough to produce 2.5 million m<sup>3</sup> per year.

The Sierra plant is located on its own land at the Tahoe-Reno Industrial Center (often referred to as TRI, but not to be confused with the gasifier developer TRI) in the City of McCarran, Storey County, approximately 20 miles east of Reno, Nevada. The plant was originally designed to produce approximately 48 000 m<sup>3</sup> of ethanol per year and 16 MW<sub>e</sub> using 81 000 tonnes of zero-cost MSW feedstock. Permits had been obtained and the construction was expected to start by the end of 2011 and to begin production in the second half of 2013. The construction costs for Sierra were estimated to be \$180 million, to be financed primarily through existing equity capital and an IPO, see below. Fulcrum was also pursuing a loan guarantee from the U.S. DOE, to fund a portion of the construction costs.

---

<sup>592</sup> <http://fulcrum-bioenergy.com>

<sup>593</sup> [tri-inc.net](http://tri-inc.net)

<sup>594</sup> [www.biofuelsdigest.com/bdigest/2011/09/26/fulcrum-bioenergys-115m-ipo-the-10-minute-version/](http://www.biofuelsdigest.com/bdigest/2011/09/26/fulcrum-bioenergys-115m-ipo-the-10-minute-version/)

<sup>595</sup> [www.sec.gov/Archives/edgar/data/1434441/000119312511254422/d234433ds1.htm](http://www.sec.gov/Archives/edgar/data/1434441/000119312511254422/d234433ds1.htm)



In 2011 the founders injected 78 million \$US and 10 million \$US Barrick Goldstrike Mines Inc., and also Waste Management invested 70 million \$US in equity<sup>596</sup>. Nevertheless, the burn rate was high, and a 115 million \$US IPO<sup>595</sup> was filed in 2011, but later withdrawn in 2012, as the company declared that it had secured 175 million \$US from other sources.<sup>597</sup> In addition, the same year Fulcrum was successful in obtaining a 105 million \$ loan guarantee for the project<sup>598</sup>.

In May 2013, it was announced that in addition to the MSW-to-ethanol project, the company had also validated an MSW-to-jet fuel concept in the company's demonstration facilities in Durham, NC (incidentally the seat of pilot facilities of the gasifier supplier TRI) and received a Department of Defence (DoD) grant of 4.7 million \$US supplementing an equal own financing for developing a project. It was stated that it would not affect the ethanol project as a different site would host the MSW-to-jet facility<sup>599</sup>, and in an interview on this topic, a slide shows a picture of a TRI gasifier, and there was also a vague reference to Brighton Colorado as the plausible site<sup>600</sup>. However, at this in time it appears that the tables have turned and the ethanol projects losses all momentum.

In August 2014, a strategic relationship with Cathay Pacific was announced with the airline taking an equity stake not disclosed, and also obtained a 1.4 million m<sup>3</sup> off-take agreement over 10 years<sup>601</sup>. In September, a loan guarantee was received from the US Department of Agriculture (USDA) for the same 105 million, but this time for a bio-jet fuel project in McCarran, the first bio-jet project being awarded a loan guarantee from USDA<sup>602</sup>. Two weeks later, it was announced that Fulcrum would receive a grant from DoD of 70 million \$US for the bio-jet project in Nevada under the Defence Procurement Act<sup>603</sup>. The plant cost was then estimated to 266 million \$US<sup>604</sup> for an output of 48000 m<sup>3</sup> of neat SPK bio-jet.

In 2015, United Airlines joined Cathay Pacific and invested 30 million \$US in the company and also signed a take-off agreement for 5.6 million m<sup>3</sup> of bio-jet over ten years. The same year the construction was initiated on the Phase 1 of the Sierra project, the feedstock processing facility<sup>605</sup>, which became operative in 2016. In 2016, also AIR BP invested 30 million and also signed a take-off agreement for 1.9 million m<sup>3</sup> of bio-jet over ten years<sup>606</sup>.

In late 2017, the company had met financial closure on the Fulcrum Sierra Biofuels project. After years of utilizing the USDA loan guarantee as the backbone for the financing, instead the Director of the State of Nevada Department of Business and Industry issued tax-exempt municipal green bonds and the proceeds of which, 150 million \$US with an option for another later issue of 25 million US\$, are loaned to Fulcrum Sierra Biofuels, which was successful<sup>607, 608, 609</sup>. Finally, in May 2018, the company could initiate Phase 2 of the Sierra project, the construction of the biorefinery<sup>610</sup>.

---

<sup>596</sup> <http://www.biofuelsdigest.com/bdigest/2011/11/21/waste-management-invests-in-fulcrum-provides-70m-debt-for-first-commercial-project/>

<sup>597</sup> Fulcrum Bioenergy Secures Commitments for \$175 Million Of Financing for Commercialization of MSW to Renewable Fuels Project. Fulcrum News Release, November 30, 2012 –

<sup>598</sup> [www.usda.gov/media/press-releases/2012/08/06/usda-guarantees-loan-support-development-nevada-advanced-biofuels](http://www.usda.gov/media/press-releases/2012/08/06/usda-guarantees-loan-support-development-nevada-advanced-biofuels)

<sup>599</sup> Fulcrum lands Phase 1 defense grant for MSW-to-jet fuel plant. Susanne Retka Schill. Ethanol Producers Magazine, May 31, 2013

<sup>600</sup> Fulcrum BioEnergy: The Digest Interview. Biofuels Digest, May 30, 2013

<sup>601</sup> Cathay Pacific invests in sustainable biojet fuel developer. Press Release, August 7, 2014

<sup>602</sup> [www.usda.gov/media/press-releases/2014/09/04/usda-announces-loan-guarantee-help-innovative-company-turn-waste](http://www.usda.gov/media/press-releases/2014/09/04/usda-announces-loan-guarantee-help-innovative-company-turn-waste)

<sup>603</sup> DOD awards 3 biofuel contracts under Defense Production Act. Anna Simet. Biomass Magazine September 19, 2014

<sup>604</sup> <http://www.biofuelsdigest.com/bdigest/2014/09/19/breaking-news-us-navy-doe-usda-award-210m-for-3-biorefineries-and-mil-spec-fuels/>

<sup>605</sup> Vecoplan to build feedstock processing system for Fulcrum Vecoplan LLC. Biomass Magazine, July 08, 2015

<sup>606</sup> <http://www.biofuelsdigest.com/bdigest/2016/11/07/air-bp-and-bp-ventures-invest-30m-in-biojet-producer-fulcrum-bioenergy-ink-500m-gallon-10-year-offtake-deal/>

<sup>607</sup> <http://www.biofuelsdigest.com/bdigest/2017/10/19/heard-on-the-floor-at-ablc-next-2017-fulcrum-prices-bonds-gop-governors-pro-biofuels-asuatlt-oin-dc/>

<sup>608</sup> <http://www.biofuelsdigest.com/bdigest/2017/12/11/i-dont-like-losses-sport-the-invention-of-bioeconomy-risk-insurance-and-fulcrum-bioenergys-leap-to-scale/>

<sup>609</sup> Fulcrum Sierra Biofuels, LLC Green Bond Revised Framework Overview and Second Party Opinion. Ankita Shukla, Charlotte Peyraud. SUSTAINALYTICS November 29, 2017

<sup>610</sup> Fulcrum BioEnergy Breaks Ground on Sierra BioFuels Plant. Press release, May 16, 2018

Already in 2017 Fulcrum was announcing plants for several sister plants to be constructed the near future, the second one to be sited in the Chicago area<sup>611</sup>.

The gasifier technology supplier ThermoChem Recovery Inc. (TRI) has its roots in Manufacturing and Technology Conversion International Inc. that in 1984 started to develop the technology using various waste and biomass feedstocks, including black liquor and RDF, with funding from DOE/NREL. The development initially was done from 1992 by tests in a 12 tpd pilot-scale reactor in Santa Fe Springs, CA and later in a 50 tpd capacity facility in Curtis Bay, Baltimore, MD, made by StoneChem, Inc., a subsidiary of MTCI's affiliate ThermoChem Recovery International, Inc. (TRI) and Stone & Webster<sup>612</sup>. TRI was founded in 1996 and today, the Abell Foundation, Inc., a Maryland foundation that invests in breakthrough clean energy technology, is the main investor. For reasons unknown to the author, what used to be referred to as the MTCI process has been gradually been attributed to both MTCI and TRI, but as of the last decade or so, solely referred to as the TRI process.

Based on the tests mentioned above, a 50 ton/day capacity black liquor gasification demonstration unit was built in 1996 at Weyerhaeuser's New Bern facility<sup>613</sup>. Commercial projects for black liquor gasification followed at Norampac's Trenton, Ontario, Canada (100 ton/day black liquor solids) with a start-up in 2003 and in 2004 the start-up of the Georgia Pacific, Big Island Virginia mill gasifiers (2\*100 tonnes/day black liquor solids). The Norampac project went through a number of technical challenges related to scale-up issues of the deep fluidized bed (pressure, bed particle size growth, low carbon conversion, and fluid bed circulation issues). The plant was operated for many years but appears to have been closed some years back<sup>614</sup>. The Big Island project had issues with higher than expected tar yields, and was closed in 2007, after the mill had been sold.

The TRI gasification technology had funding from the DOE Integrated Biorefinery Program in 2008, 30 million \$US each, for the Flambeau River project<sup>615</sup> at the Park Falls Mill, Park Falls, Wisconsin to diesel, waxes, and heat and power that from woody biomass at a scale of 900 tonnes/day and also for the New Page<sup>616</sup> integrated into the Wisconsin Rapids Mill, Wisconsin Rapids, Wisconsin to replace at a scale of 450 tonnes/day<sup>617</sup>. However, neither of these projects materialized.

To support these projects, TRI has built an integrated PDU pilot plant located at the Southern Research Institute in Durham, North Carolina. The system has a woody biomass feed capacity of 4 tonnes/day. The FT technology utilized for this project is provided by EFT, see below, with TRI being the overall project integrator. The FT system utilizes a 10% syngas slip stream from the gasifier to produce 80 litres/day of liquids and wax. The gasifier became operative in early 2009, the gas clean-up system by mid-year and the FT system at the end of 2009.

As shown above, TRI has been cooperating with Fulcrum as of at least 2013 on the MSW-Fischer Tropsch development, also involving EFT as the supplier of the synthesis technology. Interesting enough, Velocys<sup>618</sup>, another emerging FT technology supplier (engaged in the Red Rock Biofuels<sup>619</sup> project where a different gasifier technology will be used) announced that TRI was the preferred

---

<sup>611</sup> <http://www.biofuelsdigest.com/bdigest/2017/11/06/chicago-fulcrum-bioenergy-picks-the-midwest-hub-for-its-next-msw-to-jet-fuel-project/>

<sup>612</sup> Novel and innovative pyrolysis and gasification technologies for energy efficient and environmentally sound MSW disposal. Thomas Malkow. Waste Management 24 (2004) 53–79

<sup>613</sup> United States Country Report. IEA Bioenergy, Task 33. R. Bain. NREL, Task No. WW3E.1000 August 20, 2011

<sup>614</sup> Personal communication. K. Whitty, University of Utah, 2018.

<sup>615</sup> Flambeau River Biofuels Demonstration-Scale Biorefinery. US DOE, July 2011

<sup>616</sup> New Page Biofuels Demonstration-Scale Biorefinery. US DOE, July 2011

<sup>617</sup> The Thermochemical Biorefinery. Burciaga. Biomass 2010 Track 3-Hydrocarbon Fuels Near Term Opportunities.

<sup>618</sup> [www.velocys.com](http://www.velocys.com)

<sup>619</sup> [www.redrockbio.com](http://www.redrockbio.com)

supplier of gasification technology<sup>620</sup>. This “infidelity” among the gasifier and FT developers is further enhanced when Velocys in 2018 announces a partnership with gasifier supplier APP for a UK project, see Section 7.4.2.1). The latest development during the final drafting of this report September 2018 is however, that Fulcrum Bioenergy has selected the Johnson Matthey/BP as the licensor for the Sierra facility<sup>621</sup>.

The Fulcrum Sierra Biofuels plant is composed of the feedstock processing facility and the biorefinery<sup>622</sup>. The feedstock processing facility, which is located adjacent to Lockwood regional landfill with both road and rail access, has the capacity to process approximately 360000 tonnes per year of inbound MSW into approximately 180000 tonnes of baled RDF feedstock for the biorefinery as presently designed.

The primary material processed is MSW but also secondary materials, e.g. recovered materials can be part of the feed. Other recovered materials, including ferrous and nonferrous metals, and at various times corrugated cardboard and plastics sorted out from the MSW are stored, handled, used and disposed or recycled, as appropriate. The MSW is delivered by truck and uses a trailer tipper to unload onto a tipping floor, located in an enclosed processing building. A front-end loader pushes the MSW into an in-feed conveyor. The loader operators screen all MSW loads when tipped from the transfer trailer onto the tipping floor to identify and separate any items not suitable or prohibited for processing, due to their nature or size, prior to pushing the MSW onto the in-feed conveyor to the processing lines for shredding, screening, and separation.

The MSW processing begins with an elevated manual sort station to remove any remaining large or unsuitable items from the inbound MSW, and which by chutes are drop into bunkers below.

The sorted MSW is shredded and screened to remove the fines. Sized MSW is then conveyed through separation equipment to separate the heavier inert materials from the lighter organic materials, is baled and wrapped and is used as feedstock. At various times, plastics may be subject to recovery to maintain the feed specification and would then be baled for shipment to market. Magnetic separators and eddy current separators are used to remove the ferrous and non-ferrous materials, respectively, for recycling. Residual material not used as feedstock or recovered for recycling is transported to the landfill.

The feedstock bales are wrapped with a polyethylene film for storage of the feedstock. The baled feedstock, weighing approximately 1.4 tonnes per bale, would then be loaded onto flatbed trailers for transport to the biorefinery.

The “biorefinery” converts the RDF feedstock into SPK bio-jet fuel using a four-step process: feedstock preparation, steam reforming gasification, Fischer Tropsch liquids synthesis and hydroprocessing/fractionation upgrading. The plant is designed to convert nearly 180000 tonnes of feedstock per year into a permitted maximum of 48000 m<sup>3</sup> of neat SPK (synthetic paraffinic kerosene) bio-jet fuel meeting the ASTM D7566 standards.

The baled feedstock arrives to the biorefinery plant on flatbed trucks with approximately 26 bales per truckload. Approximately 700 tonnes of RDF feedstock would be delivered daily, 5 days per week. At the plant, the feedstock bales are unloaded by fork lifters and stored outside on a concrete pad sized to accommodate approximately 4 days of feed to the plant.

---

<sup>620</sup> Establishment of a strategic alliance with TRI. Velocys and TRI press release, 26 Jan 2017

<sup>621</sup> Johnson Matthey Press Release September 25, 2018

<sup>622</sup> Final Environmental Assessment. Fulcrum Sierra Biofuels LLC, Waste to Fuel Facilities in McCarran, Storey County Nevada. Jointly Executed For: Department of Defense Title Iii Program, Wright-Patterson Afb Oh 45433 and USDA - Rural Development, Washington, DC 20250. August 2014

RDF bales are fed to the steam reforming gasifier feeding system using a system of conveyors and shredders. The shredders are designed to shred the bales to a one-cubic-inch and smaller size to meet the requirements of the gasification process. A magnet removes any ferrous metal from the feedstock as it drops into the feedstock receiving hopper. The design rate for the gasifier is 500 tonnes of feedstock per day.

The shredded feedstock is introduced into the TRI steam reformer, see below, through four independent plug screw feeders that increase the biomass pressure/density and provide a gas tight seal. The steam reformer is an indirectly heated, deep, stationary fluidized bed design operating close to atmospheric pressure (0.1-0.2 MPa<sup>613</sup>) and utilizes superheated steam as the fluidizing medium. Heat input to the gasifier is provided by tubular heat exchangers immersed in the bubbling fluidized bed. Proprietary pulse combustion heaters outside of the vessel and the heat exchanger tubes provides resonance tubes that shoot pulses of hot flue gases at a rate of 60 Hz through the heat exchangers. The use of pulsation in the heat exchanger increases the tube-side heat transfer coefficient, thus increasing the overall heat transfer coefficient and facilitates in providing the endothermic energy required for the gasification process and to maintain the bed temperature at typically<sup>613</sup> 600-700 °C or more, the lowest temperatures reflecting black liquor gasification. The pulse combustors use tail gas from the downstream processes as fuel, and flue gas would be sent to a utility boiler, see below, to recover the waste heat by generating high pressure steam.

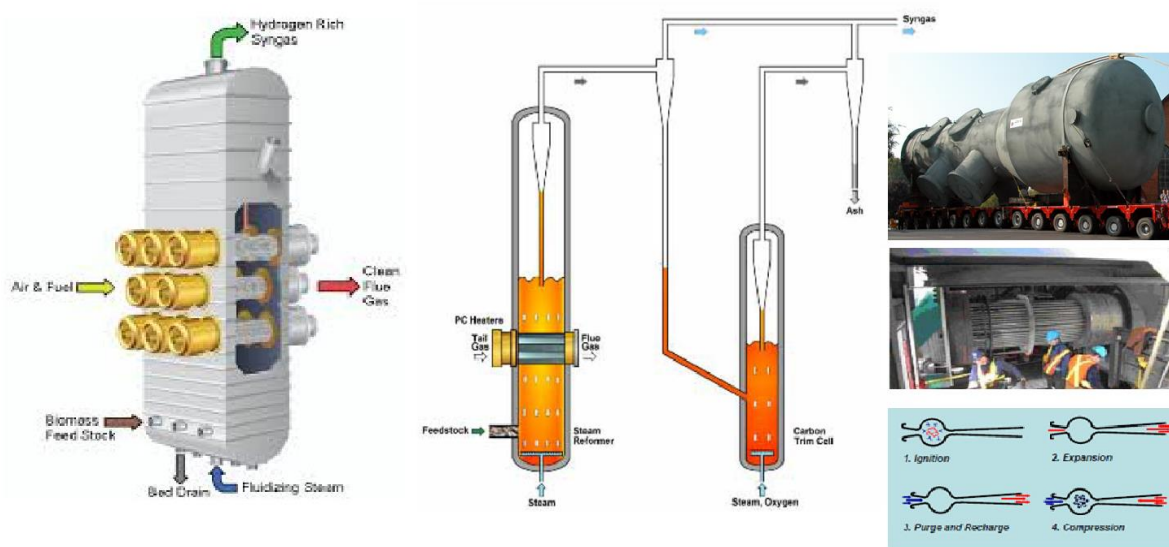

**Figure 98 The TRI's steam reforming gasifier, and pulsed combustion system<sup>623, 624, 625</sup>**

During the gasification process the feedstock rapidly heats up upon entry into the reformer vessel and almost immediately undergoes drying and pyrolysis while the remaining char reacts with the superheated steam. The pyrolysis products would undergo water-gas reactions and, together with simultaneous steam reforming and gasification of the char, result in a product gas primarily made up of H<sub>2</sub> and CO, with some hydrocarbons.

The product gas is fed into a partial oxidation reactor (POX) together with oxygen operating at higher temperatures unit to maximize the synthesis gas yield by converting any remaining hydrocarbons to syngas. In addition, several process streams from the Fischer Tropsch process and

<sup>623</sup> TRI Integrated Biorefinery Demonstration Plant. Bioenergy Deployment Consortium, April 7, 2010

<sup>624</sup> TRI Technology Update & IDL R&D Needs. D. Burciaga Biomass Indirect Liquefaction Strategy Workshop. DOE, March 20, 2014

<sup>625</sup> Black Liquor Gasification at Norampac. Bob Rowbottom, Dave Newport, Eric Connor. Black Liquor Gasification at Norampac. TAPPI 2005 Engineering, Pulping & Environmental Conference

hydroprocessing/fractionation upgrading unit that contain light hydrocarbons are recycled to the POX unit for reconversion to syngas. The hot product gas exiting the POX unit is routed to a gas cooler to which recovers the sensible heat as high-pressure steam.

The set-up described above is different to what has been described for the integrated biorefinery projects, Flambeau River and New Page<sup>623, 624</sup>. The product gas steam leaving the fluid bed reactor is sent to cyclones to remove char, which is sent to a carbon trim cell gasifier, an oxygen/steam blown fluidized bed for completing the burn-out, and the gas is after cyclone particulate removal fed back to the main product gas line. A different primary gas cleaning train is also described than above. A gas cooler reduces the gas temperature down to 260 °C for steam generation followed by a Venturi scrubber for removal of particulate, with a direct condensation gas cooler on top of the sump. In a second scrubber, using a proprietary solvent, tars are absorbed, and then there is a scrubber for sulphur removal. This gas cleaning trains appears to have been trademarked by TRI as "Kasyn™".

The oxygen used in the plant is generated by a Vacuum Swing Adsorption (VSA) unit on site, with a liquid back-up system, and the enriched off-gas would via a Pressure Swing Adsorption (PSA) system generate nitrogen for use as inert gas in the plant.

The ash that would be produced in the gasification and POX units is recovered and cooled down. It is anticipated that the ash could be a sellable co-product for construction purposes or, otherwise, disposed of a non-hazardous classified landfill.

The cooled product gas is then compressed and sent to the gas cleaning to remove contaminants. First, a Venturi scrubber captures and removes any particulates before an amine system to capture and remove sulphur and CO<sub>2</sub>. Finally, layered guard beds to polish sulphur to ppb levels and to remove mercury, mercaptans and arsine contaminants. Included in the syngas clean-up system there is a water gas shift reactor to adjust the syngas H<sub>2</sub>/CO to the ratio required for the synthesis process and a H<sub>2</sub> recovery membrane unit to extract the H<sub>2</sub> required for the hydroprocessing/fractionating upgrading unit. After gas cooling, the gas is still presumably above ambient and with a steam gasifier, loaded with steam it would make sense to cool and condense the steam before the compressor to achieve the cleaning effect on particulates and acid gases, notably HCl while also saving on compression energy. Alternatively, this is a first stage compression, followed by a second stage compressor after parts of the gas cleaning, e.g. after the amine wash. There is a reference to a dry filter downstream the Venturi in another section of the document, which may be linked to the two-stage compressor alternative. COS hydrolysis catalysts appear in the list of materials. And it is said that sulphur ultimately is removed as a solid, implicating that the amine-wash stripper gases are treated in a LOX process before CO<sub>2</sub> is vented.

The treated product gas from the gas clean-up section would now be at the required purity and composition for the Fischer Tropsch (FT) process. The FT process and the product upgrading were planned to be designed by Emerging Fuel Technologies<sup>626</sup> (EFT), a company which was established in 2007 but has its roots in the FT developer Syntroleum. EFT has worked together with TRI for other projects. In the FT process, the H<sub>2</sub> and CO in the syngas react to form long chain paraffinic liquid hydrocarbons as it passes through the catalyst filled tubular FT reactors. Steam jackets on the FT reactors provide cooling to the exothermic FT reactions by generating steam for use within the biorefinery. However, as was noted above<sup>621</sup>, in September it was announced that the JM/BP system, also this a tubular FT reactor design would be installed instead.

The liquid fraction formed directly in the reactor, the high-boiling liquid product, is separated from

---

<sup>626</sup> emergingfuels.com

the gas and vapours, filtered and sent to the high-boiling liquid intermediate storage tank. The remaining vapor-gas fraction goes through two additional condenser and separation stages to separate medium-boiling liquid product and low-boiling liquid product, respectively. The former fraction is transferred to an intermediate product storage tanks, and the low-boiling liquid product is recycled back to the POX unit. Additionally, any syngas that would not be converted in the FT reactor (or the C1 to C4 by-product formed) may be used as tail gas in the pulse combustion heaters, utility boiler or recycled to the POX Unit.

The high- and medium-boiling liquid product streams are pumped to a hydrocracker unit, a high temperature/high pressure catalytic process and fractionator to convert the FT liquids to SPK bio-jet fuel. The hydroprocessing reactions include saturation of the alcohols and olefins, isomerization/hydrocracking of the alkanes and long paraffinic hydrocarbon chains. Purified hydrogen extracted in the gas cleaning process provides the necessary hydrogen. The product stream is sent to a fractionator for separation and recovery of SPK bio-jet product. The fractionator light ends, naphtha, and non-condensable off-gas formed by the hydroprocessing reactions are recycled back to the POX unit to be re-gasified to synthesis gas. The fractionator heavy fraction is recycled back to the hydrocracker inlet for additional processing. The fractionator SPK product is routed to storage for final testing and distribution to the three product tanks, from where it is pumped to a truck filling station.

A portion of the purge gas would be used as fuel gas in a utility boiler to produce steam to be used in the biorefinery, indirectly offsetting a portion of electric power requirements.

A boiler is installed to provide process steam and be fired on both a process purge gas and natural gas to produce steam to be used in the biorefinery, indirectly offsetting a portion of electric power requirements by means of a turbine. The plant also holds conventional utility units for such a plant, flare, emergency power unit, waste water treatment facilities etc.

#### **7.4.2.5. Synova<sup>627</sup>, ECN<sup>628</sup>, Dahlman<sup>629</sup> and Ambigo<sup>630</sup>**

The Energy research Centre of the Netherlands ECN (since April 2018 integrated in TNO, thus now called ECN part of TNO), located in Petten, North Holland, the Netherlands, was formed as the Reactor Center Netherlands in 1978 reflecting that the activities had been broadened also into other forms of energy. This broadening also included the use and processing of biomass. ECN is well-known for its work on biomass gasification and torrefaction. Of particular significance in the context of this report are the activities in gasification, gas cleaning and synthesis gas conversion.

In 1998, ECN invented the OLGA process for tar removal from gasification gases which is described in more detail in Section 6.2.2.3. In the year 2000, the Milena indirect gasification system was invented and in 2008 this development reached a pilot plant scale (800 kW<sub>th</sub>). In 2010 the ECN System for MEthanation (ESME) process was developed<sup>631</sup>. These inventions are covered by patents. Both these systems are described below.

In 2001 Royal Dahlman was invited to participate in the development of the OLGA tar removal technology and also licensed it in 2006. The company also licensed the Milena technology. In 2017, a joint venture was launched by ECN and Dahlman Renewable Technologies, called MOJI BV, for the commercialization of MILENA and OLGA technologies<sup>632</sup>.

---

<sup>627</sup> [synovapower.com](http://synovapower.com)

<sup>628</sup> [www.tno.nl/](http://www.tno.nl/)

<sup>629</sup> <https://www.royaldahlman.com/company-profile/>

<sup>630</sup> [www.ambigo.nl](http://www.ambigo.nl)

<sup>631</sup> Ambigo: De noodzaak van partnerships. M.H.F. Overwijk, R.M. de Vries. Biobased Industries, April 2017. ECN-L--17-007

<sup>632</sup> [www.ecn.nl/nl/nieuws/item/new-joint-venture-moji-to-fast-track-dutch-gasification-technology-commercialization/](http://www.ecn.nl/nl/nieuws/item/new-joint-venture-moji-to-fast-track-dutch-gasification-technology-commercialization/)

Dahlman's origins go back to an old family business founded in 1886. Since then, Dahlman has grown to be a major supplier to the oil, gas and petrochemicals industry as well as to power and renewable energy industries, supplying gas cleaning and gas filtration equipment, power and renewable energy markets. In 2011 Dahlman received the honourable name of Royal Dahlman by designation from former Majesty Queen Beatrix of the Netherlands. In 2007 Royal Dahlman started its renewable business, Dahlman Renewable Technologies, DRT. Apart from selling products, Royal Dahlman has had an increasing ambition to act as an integrator to provide turn-key solutions for biomass or waste to power projects. A few OLGA projects have been sold for gasification plants in France (2006), Portugal (2009), and the most recent in India (2014).

From 2008, ECN together with Royal Dahlman and HVC Alkmaar (originally a local waste incineration company) developed plans to demonstrate MILENA gasification and OLGA tar removal technology at 12 MW scale. The idea was to produce power and heat initially and SNG eventually from clean wood<sup>633</sup>. This project was pursued for a number of years and eventually was refocused with a slightly different composition of the consortium and named AMBIGO. The AMBIGO project is further described below.

In 2012, the US company Synova LLC took a minority stake in Royal Dahlman<sup>634</sup> in line with a mutual interest in developing waste to energy projects. The same year, Royal Dahlman also responded to the to the ETI's April 2012 waste gasification project request for proposals<sup>635</sup> and was one of the three contenders selected for the second phase, the other two being Syntech Bioenergy, see Section 7.3.2.9, and APP, see Section 7.4.2.1. The second phase of the project included presenting the design and a business plan package to demonstrate a 5–20 MW<sub>e</sub> waste -to-energy technology in a demonstrator at least facility at the 0.5-3 MW<sub>e</sub> scale range, and where ETI would be a major investor in the third phase, the realization of the project. Royal Dahlman<sup>636</sup> started to develop a project of 7 MW<sub>e</sub> in Grimsby, UK, see below. However, following the ETI's selection of Syntech Bioenergy in 2014, this project was not pursued. The estimated cost for this installation is not public.

In 2013, the company received an order for the first commercial integrated plant incorporating both MILENA and OLGA with a capacity of 4 MW<sub>th</sub> with the clean product gas utilized in a 1 MW<sub>e</sub> gas engine<sup>637</sup>. The project is in co-operation with the Indian firm Thermax, which was responsible for the construction of the plant. The fuel is biomass waste from soy bean harvest for use in one of Ruchi Soya Industries soy bean processing factories. The plant became operative in 2015.

In 2014, the Portuguese plant at Tondela was refurbished to demonstrate the OLGA concept for RDF. The site was operated since 2009 by the Portuguese company Iberfer to demonstrate the gasification of chicken manure (4 MW<sub>th</sub>) in a CFB gasifier installed by the Dutch company HoST, OLGA gas cleaning and a 1 MW<sub>e</sub> Caterpillar gas engine. RDF gasification was successfully demonstrated in an 18-month test period<sup>638</sup>.

In 2017, ECN and Dahlman Renewable Technology (DRT) launched a new 50/50 joint venture MOJI (Milena Olga Joint Innovation B.V.) to fast track the commercialisation of their gasification technology<sup>639</sup> by adding IPR of both sides to the JV, which is managed by Synova<sup>640</sup>. One month

---

<sup>633</sup> The Alkmaar 4 MW bio-SNG demo project. Luc P.L.M. Rabou, Mark H.F. Overwijk. 3rd International Conference on Renewable Energy Gas Technology Malmö, Sweden 2016. ECN-M--16-032. ECN March 2016

<sup>634</sup> Synova invests in Royal Dahlman. Press release 21-09-2012

<sup>635</sup> Targeting New and Cleaner Uses for Wastes and Biomass Using Gasification. Geraint Evans Energy Technologies Institute, 2017

<sup>636</sup> Renewable Energy Plant Could Come to Grimsby. Grimsby Telegraph. January 31, 2014

<sup>637</sup> MILENA Gasifier under Construction. Press release 19-12-2014

<sup>638</sup> Successful WTE demonstration completed in Portugal. Press release 02-07-2015

<sup>639</sup> New joint venture MOJI to fast track Dutch gasification technology commercialization. Press release April 19, 2017

<sup>640</sup> [synovapower.com/partners/](http://synovapower.com/partners/)

later, it was announced that Synova bought out DRT from Royal Dahlman<sup>641</sup>. So, there is a strong cooperation between these three entities, further reinforced by that some former ECN staff have moved to these two companies during the period from their first collaboration.

The third party in this group of companies, Synova LLC, is an American project developer specializing in waste-to-energy projects, with a special focus on integrated gasification combined cycle (IGCC) plants, planned in North America, Europe and Asia. Synova is headquartered in Los Angeles with operations in the Netherlands and active projects focused in Southeast Asia, Europe, and the USA. The antecedents of this company, such as date of foundation, major stakeholders and activities before surfacing in the Netherlands in 2012 have not been possible to establish from open sources. On their web page<sup>627</sup>, Synova names Ecosystem Integrity Fund<sup>642</sup> as an early investor, and that FullCycle Energy Fund<sup>643</sup>, founded in 2013, is Synova's project finance affiliate. Caterpillar Ventures and FullCycle Energy participated in the first closing of a bridge financing<sup>644</sup> for the DRT take-over in 2017.

The Synova project portfolio, apart from AMBIGO, is based on modules at three nominal capacities, M6, M30 and M70, the numbers roughly referring to the module nominal thermal input on MW. Synova focuses on Thailand now as policy interventions are being made to improve the waste management situation in the country<sup>645</sup>. An M6 plant using engines is planned to be built north of Bangkok Thailand, the final investment decision is expected in second half of 2018. An M30 project, also North of Bangkok next to landfill, is in the pipe with FEED system completed but waiting for a PPA expected in 2019. PPA. The M70 module, using a gas turbine, is to be designed, but is seen as an important Synova product<sup>646</sup>.

Regarding the AMBIGO project, this project traces back its roots to the project initiated by ECN, Dahlman and HVC in 2008. In 2012, the HVC project had attracted government support. Nevertheless, in 2014, market developments forced HVC to withdraw. Instead, Gasunie, the Dutch gas grid company, stepped in as the lead partner, together with other and the support from local and regional government. This however changed the project focus towards bio-methane rather than heat and power production. In 2015, PDENH, the development fund of the province of North Holland became a project partner, and in 2016 also Engie (former Gas de France) joined the consortium. By then the basic engineering for a 4 MW bio-methane plant in Alkmaar had been completed and all permits required were secured. In 2017 a government subsidy for the project was obtained<sup>647</sup>, while DRT has now been taken over by Synova. The project development is ongoing, albeit with some delays, and by mid-2018, a final investment decision was expected shortly. The overall budget is estimated to 25 M€ of which 6.5 million € total are grants from the government and the province supplemented by a 4 million € loan from the government<sup>648, 649</sup>.

Below is a short description of the design proposed by DRT for the Grimsby plant<sup>650</sup>. The expected throughput of the facility was 53 600 tonnes per year. The energy within this fuel, approximately 24 MW thermal, will be used to generate 8.8 MW<sub>e</sub> via an integrated gas turbine combined cycle, 5.7

<sup>641</sup> Synova to acquire Dahlman Renewable Technology. Press release May 2, 2017

<sup>642</sup> [www.ecosystemintegrity.com](http://www.ecosystemintegrity.com)

<sup>643</sup> [fullcyclefund.com](http://fullcyclefund.com)

<sup>644</sup> Caterpillar Venture Capital Invests in Synova Power to Advance Next Generation Waste to Energy Technology. Synova press release, July 19, 2017

<sup>645</sup> Municipal solid waste management in Thailand and disposal emission inventory. C. Chiemchaisri & J. P. Juanga & C. Visvanathan. Environmental Monitoring and Assessment. January 2008

<sup>646</sup> Personal communication, Bram van der Drift, Synova, 2018

<sup>647</sup> Towards the commercialization of the ESME technology for bio-SNG production – The AMBIGO project M.H.F. Overwijk, L.P.L.M. Rabou, B.J. Vreugdenhil, C.M. van der Meijden, G. Aranda Almansa ECN-L-17-025

<sup>648</sup> Betreft: Verlenen subsidie Project: Ambigo (voorheen Milena, Olga, Esme). Letter from Provincie Noord-Holland to Royal Dahlman, July 27, 2017.

<sup>649</sup> Subsidiebeschikking Ambigo. Verplichtingnummer. Ministerie van Economische Zaken en Klimaat. 21 december 2017

<sup>650</sup> Decision document. Permit Number: EPR/DP3132EY/A001. Dahlman Renewable Technology B. V. Grimsby Renewable Power. Environmental Agency, 23/12/2014



MW<sub>e</sub> of electricity via a gas turbine (Solar Taurus-60) and 3.1 MW<sub>e</sub> of electricity via the steam turbine. After deduction of the plants parasitic load, 1.8 MW<sub>e</sub>, a net of 7 MW<sub>e</sub> net electricity would have been exported to the grid.

The fuel, RDF or SRF, are delivered to the site by lorries as ready prepared bales and discharged via an automated offloading system to allocated storage areas. Clean wood biomass is used for start-up is also unloaded automatically and stored separately in a silo.

Fuels are transported from the storage area via a shredder to reduce the size to below 100 mm and is then transported by a conveyor to a feed collector/mixer. When correctly mixed, it is transported from the mixer to one of four dosing bunkers of approximately 1-hour hold-up to ensure redundancy, two being dedicated to wood and two for RDF or SRF. From the dosing bunkers the fuel is transported in two parallel systems by rotary valves and two (pressure equalization) valves, to maintain pressure control and avoid gas leakages, at the fuel input to a weighing screw conveyor that feeds into the MILENA gasifier.

The MILENA gasification technology<sup>633</sup>, see Figure 99, was developed to convert biomass into product gas with low N<sub>2</sub> content without the need for an O<sub>2</sub> separation plant. This is achieved by indirect gasification in a circulating fluidized bed, and combustion of remaining char with air in a separate bubbling fluidized bed. Heat is transported from the combustion reactor to the gasification reactor, and char from the gasification reactor to the combustion reactor, by bed material such as sand or olivine. Olivine/sand is continually replenished into the process.

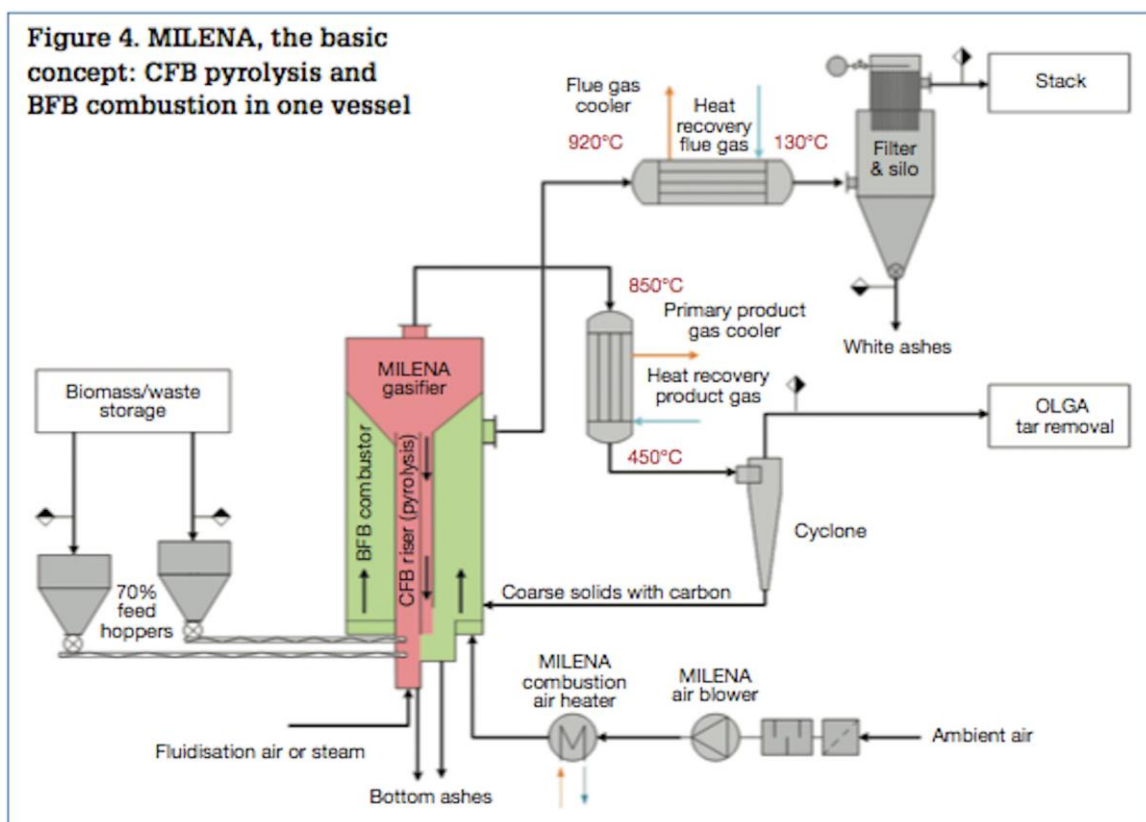

**Figure 99 The Milena gasification reactor<sup>651</sup>**

<sup>651</sup> MILENA and OLGA get together for high efficiency and low tar. Modern Power Systems, 1 January 2015

The gasification and combustion reactors are integrated within a single vessel, with the combustion reactor in an annulus surrounding the gasification reactor. This configuration is claimed to facilitate the reduction of heat losses, and in the future to have the possibility to raise the operating pressure from atmospheric to about 0.6 MPa. Char and bed material are separated from product gas in a freeboard and flow to the combustion reactor through a downcomer.

The circulating fluidized bed (riser) of the gasification reactor requires little steam or other gas for its initial fluidization. This reduces the heat demand of the process and results in product gas with relatively low steam content, approximately 35 vol.%. This reduces the cooling loads to cool and dry the gas to ambient temperature for further cleaning and compression, as required.

The conversion of fuel into product gas is approximately 80-90 % carbon conversion within the pyrolysis zone. The riser temperature is 850 C for woody biomass and lower for waste fuels<sup>652</sup>. However, unlike conventional direct gasifiers, the remaining 10-20% carbon, together with ash and bed material is sent to the combustion section directly via the internal downcomer.

The combustor operates typically at 925 °C with woody biomass. Auxiliary gas burners will be installed to ensure the temperature does not fall below 850°C and this will be controlled by the system automation. Residence time for the CFB combustor is at least 2 seconds. Ash and tar captured by the cyclones as part of the cleaning of the product gas in the OLGA system, see below, are also sent to the combustion section of the MILENA. In this combustion section the char and tars are fully combusted. As such, the overall carbon conversion is stated by the operator to be 100% and both fly ash from the combustion section, as well as bottom ashes from the gasification section are carbon free and non-pyrophoric.

The flue gases from the gasifier will first be cooled and then pass through a bag filter, to which lime and activated carbon is injected. The solids are then taken from this filter for off-site waste disposal.

The MILENA product gas, see Table 39, is essentially a pyrolysis gas mixed with products of reactions with steam. It contains considerable amounts of hydrocarbons, which contribute more than 50% of the gas heating value. The gas also contains about 40 g/Nm<sup>3</sup> tar, i.e. hydrocarbons heavier than toluene.

**Table 39 Typical Milena gas composition for wood gasification<sup>633</sup>**

Example gas composition	CO	H <sub>2</sub>	CO <sub>2</sub>	CH <sub>4</sub>	C <sub>2</sub> H <sub>4</sub>	N <sub>2</sub>	BTX	Other C <sub>x</sub> H <sub>y</sub> , NH <sub>3</sub> , H <sub>2</sub> S	Typical LHV MJ/Nm <sup>3</sup>
% vol	34	24	17	15	5	3	1	1	17-23

The raw product gas is cooled to approximately 500 °C, safely above tar dew point, in a gas cooler generating steam. The bulk of the remaining dust is captured by a cyclone at 500 °C before feeding the gas to the OLGA process, see Section 6.2.2 and Figure 100. OLGA is a tar removal system which consists of the staged removal of heavy and light tars using oil scrubbing columns. The first recirculation loop of OLGA (collector) cools the gas to approximately 90 °C, i.e. above the water dew point, capturing the condensed heavy tars. This first loop contains an oil wetted ESP capturing fine particulate and entrained tar aerosols. Most of the metals are captured in this wet scrubbing / ESP line. The heavy tar fraction is separated from the oil and recirculated to the combustor side of the MILENA gasifier. The second recirculation loop in the OLGA system (absorber) absorbs the light tars without further cooling of the product gas.

<sup>652</sup> Personal communication 2018 Guadalupe Aranda Almansa, ECN part of TNO

Tar dew point downstream OLGA is well below 20 °C. Key components for light tar removal are phenol and naphthalene. The light tars will be removed from the oil by stripping with air. The tar-laden air is then recirculated to the MILENA combustion section, thus recovering the energy contained in the tars.

A first water scrubber after OLGA cools the product gas to 30-40°C (depending on ambient conditions) to decrease the steam content by condensation from 30-35 vol. % to approximately 6 vol.%. The water scrubber also removes HCl, and some NH<sub>3</sub> and HCN. A second water scrubber, not shown below in Figure 100, includes pH control and an acid dosing system to optimize the absorption of NH<sub>3</sub>.

Finally, the multi-stage compressor raises the product gas pressure to slightly above the requirements for the gas turbine (gas application in the Grimsby project). Further water removal will take place in the inter-stage coolers.

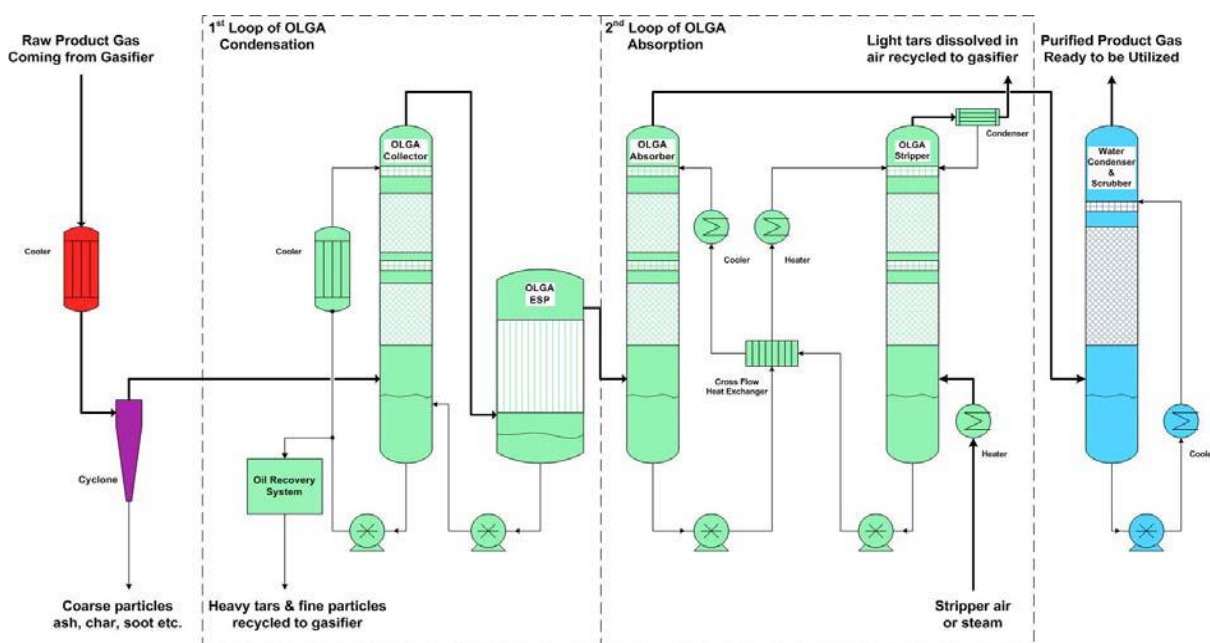

**Figure 100 The OLGA gas cleaning process<sup>653</sup>**

The gas is routed to the gas turbine via a small volume buffer and is combusted with the gas turbine air and the resulting hot flue gases are expanded to generate the drive shaft power for the gas turbine compressor and a generator. The turbine exhaust gas is still at high temperature. This sensible heat, and also the heat recovered from the gasifier gas cooling and combustor flue gas cooling, respectively, are transferred to superheated steam in a heat recovery steam generator, HRSG. The steam is used to generate more power by means of a steam turbine.

To reduce the NO<sub>x</sub> level of the gas, the HRSG contains a selective catalytic reduction stage. Since the Grimsby plant was not planned to contain a pre-combustion gas clean-up, a post-combustion clean-up system using a dry clean-up using lime was considered for this installation.

The AMBIGO project (to be located in Alkmaar, The Netherlands), which is permitted for the use of both biomass and RDF, has the same basic set-up as above, although the capacity is smaller, 4 MW<sub>th</sub> input and 300 Nm<sup>3</sup>/h bio-methane output i.e. approximately 70 % efficiency. Based on the

<sup>653</sup> Gasification. OLGA Tar Removal. Dahlman INFO May 2013

budgeted economy and the financing described above, the minimum sales price of the gas is expected to be 60-80 €/MWh<sup>649</sup>. Up to the inlet off the compressor<sup>654</sup>, the process is basically the same. For the ESME (ECN System for Methanation) process, see Figure 101, the gas is only compressed to 0.6 MPa before passing a hydrodesulphurization (HDS) catalyst.

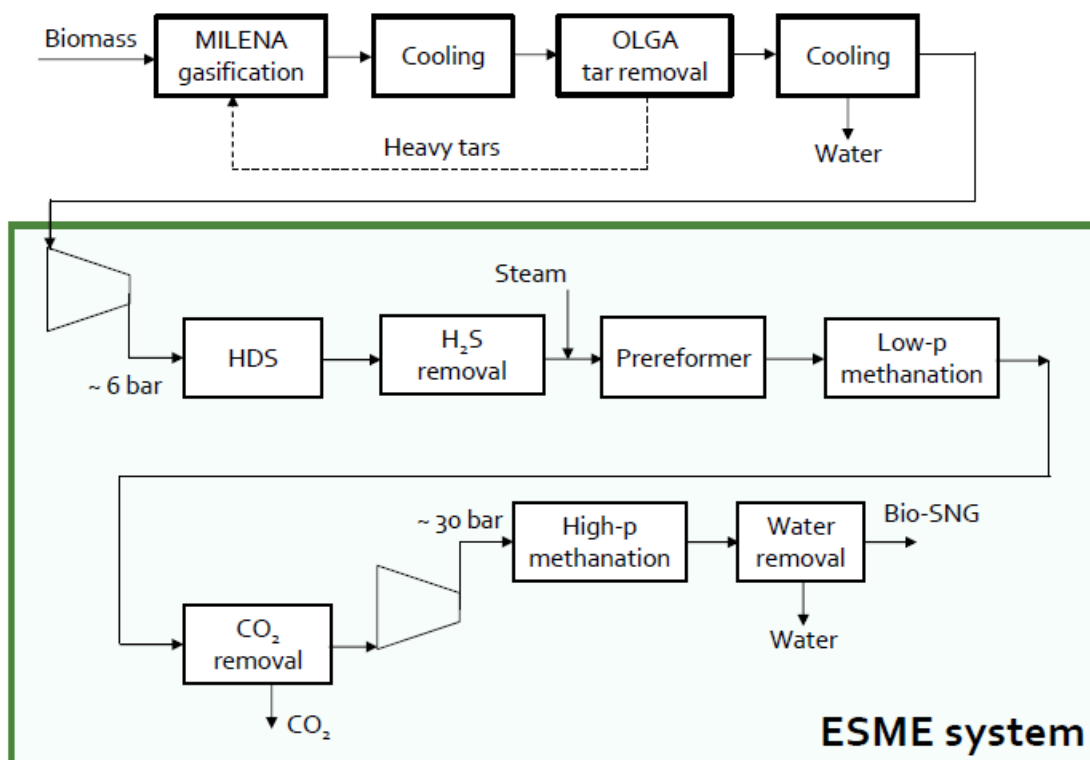

**Figure 101** The AMBIGO project block diagram highlighting the ESME process<sup>647</sup>

The HDS unit consists of a fixed-bed reactor filled with a commercial CoMo catalyst at 280°C. The HDS catalyst converts the organic sulphur compounds (e.g. thiophene, mercaptans) into H<sub>2</sub>S and COS, and also hydrogenates alkanes and alkynes into alkanes (e.g. C<sub>2</sub>H<sub>4</sub> and C<sub>2</sub>H<sub>2</sub> into C<sub>2</sub>H<sub>6</sub>). The WGS reaction also takes place in this reactor. The produced H<sub>2</sub>S and COS are removed from the gas downstream in a conventional adsorption ZnO bed and a guard bed. The pre-reformer unit is a fixed bed filled with a commercial Ni-based catalyst. Steam is added to the gas upstream the reactor at 340°C, which simultaneously reforms aromatic hydrocarbons (benzene, toluene) and produces methane, i.e. unlike other methanation processes, separation of BTX is not necessary and BTX adds to the methane yield, thus also reducing the heat load on the methanation stages. The pre-reforming reactor is followed by the low-pressure methanation reactor, using nickel catalyst in an adiabatic reactor. The gas is then cooled, and CO<sub>2</sub> removed in an amine wash system. The remaining gas is further compressed to 25-30 bar and then passes the high-pressure methanation section. Following this reactor, the CO level has been reduced to below gas grid specification. The gas is then cooled to condense steam prior to glycerol drying unit designed to meet pipeline dew point requirements. Depending on circumstances, the gas may then be compressed to gas grid pressure and spiked with LPG to meet the Wobbe Index specification. The advantage of ESME is that, like the Vesta process, see Section 7.4.2.1, are once-through processes that distribute the methanation reaction heat release over several steps without the use of extensive recirculation of gas for temperature control. This simplifies the process making it less costly.

<sup>649</sup> ECN System for Methanation (ESME). G. Aranda Almansa, L.P.L.M. Rabou, C.M. van der Meijden, A. van der Drift. 23rd European Biomass Conference and Exhibition (EUBCE 2015). 1-4 June 2015. Vienna, Austria. ECN-M--15-028, June 2015

#### 7.4.2.6. Other processes

Ecoloop GmbH, Germany, is developing waste plastic gasification using a haft kiln and lime to absorb impurities such as chloride.<sup>655</sup> A first pilot plant of 50000 tonnes of wastes, or 32 MW thermal, has been used for test operations with different waste materials.

New Planet Energy<sup>578</sup> is cooperating with TRI, see Section 7.4.2.4, on gasification of MSW for a Fischer Tropsch project in planning at Stony Point, NY, USA.

LanzaTech<sup>656</sup>, which develops fermentation of steel mill off-gases and synthesis gas, and SEKISUI Chemical Co., Ltd., a Japanese diversified chemicals company have validated a waste to chemicals platform for the conversion MSW to new products such as ethanol and chemicals<sup>657</sup>. At an existing gasification plant at a landfill site outside of Tokyo a slipstream of the gas used in a 20 m<sup>3</sup>/year fermentation system from LanzaTech after cleaning and upgrading to meet Lanzatech's specification in a system provided by SEKISUI. A demonstration program was operated between 2013 and 2017. No details on what type of gasification or the gas cleaning is used at this site have been found. SEKISUI is looking for partners to establish a facility in Japan targeted for 2019. As was noted above<sup>375</sup>, Lanzatech and Concorde Blue announced a cooperation in 2012, but this does not appear to have materialized. In the area of biomass gasification, Lanzatech is engaged in a project in California that is developed by Aemetis, and where InEnTec<sup>658</sup> plasma gasification system will be used and where validation tests have been done recently<sup>659</sup>. The InEnTEC gasifier was the gasification system previously considered for the Fulcrum plant, see Section 7.4.2.4.

Solena<sup>660</sup> was a company that originated from the same developments in Westinghouse as AlterNRG, see Section 7.3.2.1. The company was focusing on using a very similar gasification technology as AlterNRG to produce fuels, in particular jet fuel, from waste via the Fischer Tropsch process. The company had for a period of time a high profile and established numerous cooperation's with airlines. The most notable was the cooperation with British Airways aiming to build a 600000 tonnes per year waste gasifier in London<sup>661</sup> to produce jet fuel, diesel and naphtha. However, the company had problems with reaching financial closure and went bankrupt in late 2015.

## 8. Discussion

The discussion in this section focuses solely on the use of waste gasification integrated with gas cleaning to eliminate a number of contaminants, and two-stage incinerators are not considered here. The reason for this is that the focus of this study is on waste gasification technologies utilizing gas cleaning to gain performance advantages. Using gasification systems that from most important aspects, such as energetic and environmental performance, are similar to conventional waste incinerators adds little from a circular economy point of view, whereas use of gas cleaning allows higher efficiency and potential for production of other energy carriers than electric power. The status of such systems and the efforts to develop waste gasification and gas cleaning to a proven technology is therefore more interesting in a mid- to long-term perspective.

---

<sup>655</sup> [www.ecoloop.eu](http://www.ecoloop.eu)

<sup>656</sup> [www.lanzatech.com/](http://www.lanzatech.com/)

<sup>657</sup> Turning "Garbage" into Ethanol. Establishing a first-in-the-world innovative production technology. Press release. Sekisui Chemical, December 6, 2017.

<sup>658</sup> <http://www.inentec.com>

<sup>659</sup> Aemetis Completes Operation of Cellulosic Ethanol Integrated Demonstration Unit. Aemetis Press Release, March 6, 2018

<sup>660</sup> An Introduction to SOLENA FUELS CORPORATION. Brian Milikosky. World Waste to Energy City Summit London, UK, May 19-20, 2015

<sup>661</sup> Solena Fuels files for bankruptcy. Bioenergy International, Oct. 25, 2015.

## 8.1. R&D NEEDS

The heterogenous aspects of waste fuels means that improvement in the quality of handling and mechanical transport, i.e. the quality of the pre-treatment in separating non-combustible and low-melting material, and safe, reliable and controlled feeding of fluffy materials, are areas where improvement would result in improved availability and performance.

Other improvements would be to supervise some key features of the as-fed fuel on-line, e.g. moisture, chlorine content, etc., to allow feed-forward process optimisation in the gasifier and for the gas cleaning. For waste separation and incineration plants, NIR techniques are being introduced to monitor moisture and chlorine content by correlations and can also be used to estimate derived properties such as fossil carbon content and energy content, etc.<sup>662, 663, 664,665</sup>. XRF-technologies are used measure troublesome metals, glass and halogenated compounds<sup>666, 667, 668</sup>.

The feeding and dosing of a heterogenous material with typically low bulk density is also an area where developments of feed systems and components would be of use for waste treatment developers alike, including gasifier developers. Feed system outages is a common cause of down-time and loss of availability in gasifiers feeding biomass and wastes. The restart procedure, even from hot start conditions, takes time. Even a short interruption of the actual feeding leading to a trip causes down-time of typically hours before the plant is back to operating conditions, in particular for plants with many downstream cleaning and upgrading process steps. Therefore, feed system reliability also has an economic impact. There is also a safety aspect of the feed system, as it serves as the barrier for escape of the combustible and toxic gases in the gasifier, in particular if gasification at some level of pressure above atmospheric is used. This is therefore also an area where gasification differs from incinerators which typically operates at a slight underpressure and can accept that air enters the furnace as a means of reducing smell problems.

Regarding the gasification step itself, as can be seen from the above text, there are a number of two-stage gasification systems, fixed beds, stationary and circulation fluidized beds, which operate on wastes and RDF, such that the main R&D need is not in the gasification step itself, although there is always room for improvements. In view of the many types of gasifiers being considered for waste fuels, also the R&D issues vary between the gasifier types so that generalisation is difficult. Since many types of gasifiers, e.g. grates, fluidized beds, kilns have more or less direct analogies with incinerators designs, there are some common features that can be improved by R&D, issues with e.g. grate blockages etc., optimisation of air distribution etc.

For fluidized beds, the choice of bed materials, both from cost and mechanical stability perspectives, as well as from interactions with the fuel inorganic components is important. Even if this has been extensively studied, both for gasification and incineration conditions, there is an improvement potential in the understanding of such interactions. In addition, the effect of bed materials on the contaminants, and in particular on the tar components is of interest. A bed material that apart from being low-cost, chemically and mechanically stable etc. simultaneously also has a high activity for

---

<sup>662</sup>Critical review of real-time methods for solid waste characterisation: informing material recovery and fuel production. C. Vrancken, P.J. Longhurst, S.T. Wagland. Waste Management, Vol. 61, March 2017, pp. 40-57

<sup>663</sup> Utilization of Near Infrared (NIR) Spectrometry for Detection of Glass in the Waste-based Fuel. Jan Skvaril *et al.* Energy Procedia 75 (2015) 734 – 741

<sup>664</sup> Quality control of substitute fuels with UniSort online analysis. STEINERT Elektromagnetbau GmbH, undated

<sup>665</sup> Shredder residues: Problematic substances in relation to resource recovery. Environmental Project No. 1568, 2014. Jiri Hyks, Anke Oberender, Ole Hjelmar, Ciprian Cimpan, Henrik Wenzel, Guilin Hu, Jesper Cramer. Miljøstyrelsen (Environmental Board), Denmark, 2014

<sup>666</sup> XRF–New Applications in Sensor-Based-Sorting Using X-ray Fluorescence. Martin Weiss. Waste Management, vol3, pp.139-148. TK Verlag, 2012.

<sup>667</sup> Online sorting of recovered wood waste by automated XRF-technology: part I, detection of preservative-treated wood waste and part II. Sorting efficiencies. Hasan A.R. *et al.* Waste Manag. 2011 Apr;31(4):688-694 and 695-704, respectively.

<sup>668</sup> Applicability of portable XRF systems for screening waste loads on hazardous substances as incoming inspection at waste handling plants. C. Vanhoof *et al.* X-Ray Spectrometry 42(4):224-231, July 2013

reducing tars already in the gasifier would have been ideal. However, the search for this catalytically active bed material has at present not resulted in that any such a bed material has been identified, at least not when considering also other boundary conditions. The conditions inside a gasifier may, due to contact time limitations between hydrocarbons formed during devolatilization and a bed material, limit the *in situ* effect even of a very active catalytic bed material. Nevertheless, even if a bed material does not reduce tars significantly in relation to the total tar level, selective reduction of e.g. the heaviest fractions already in the gasifier can have significant impact on the downstream gas cooling and gas cleaning, as evidence from the GoBiGas experience<sup>195</sup>.

One of the main differences between incineration and gasification is the generation of significant quantities of tars in the latter process. Methods for the conversion of tar or their removal are one of the process development issues that has high priority, as the presence of tars also is interrelated to other cleaning operations, to heat recovery and in some cases also to water treatment.

The main pathway followed for reducing tars in the gasifier raw product gas is by thermal treatment downstream of the gasifier. Sufficiently good results have been obtained by various developers using both an oxidant or an oxidant plasma combination in laboratory and pilot plant scale to include this in the scale-up to the industrial prototype scale. When scaling-up such a gas cleaning technique, it is important to have an understanding for what is the "chemical" effect of the mixing/reaction zone in the flame volume, the hold time of the homogenous gas volume at temperature, wall quenching effects etc., the mixing of oxidant and gas in the flame volume as well as the mixing between the gas in these different volumes, respectively. There is also a need to develop predictive CFD models to allow the use of such basic process data for the scale-up of reactor system to ensure that the performance from pilot or demonstration units can be retained at the increased capacity.

Scrubbing systems are also being used and but the number of scrubbing liquids in use has been limited to RME and the proprietary OLGA scrubbing liquids. R&D to find other suitable scrubbing liquids, using own-generated fluids or liquid products and by-products from other industries is of interest.

Another area of importance is the heat recovery downstream the gasifier. The sensible heat of the gas can comprise 10-20 % of the energy content of the fuel, which in a steam turbine could potentially generate 2-5 % points of additional electrical energy a bottoming cycle, in addition to what a prime mover could generate, and thus significantly increase the overall efficiency. Due to the technical and operational challenges with gas cooling, many installations use a direct quench from more or less gasifier outlet temperature down to more or less ambient temperature, e.g. AlterNRG / Air Products at Teesside, whereby this potential is lost. On the other hand, the experience from e.g. Amergas with fouling in the gas cooler indicates that this is an area where R&D, with emphasis on the D, "development", part could increase the potential. Optimising the gas cooling vs. fouling and tar condensation and its integration into a steam could make a large fraction of this sensible energy available for heat recovery.

What defines true gasification from incinerators, one- or two-stage, is the opportunity for pre-combustion cleaning. In some cases, the same kind of filters and chemicals that are used also for post-combustion cleaning can be used, assuming that other contaminants, notably tar, have been reduced to a level where they do not interfere with e.g. filter operation. This can apply to particulate removal in high-temperature filters at > 300 °C, in conventional filters at 200 °C or WESPs, absorption of strong acids like HCl, HF and to removal of heavy metals including Hg. Under such circumstances, there are technologies available that only need some adaption for the gasification application.

However, when it comes to sulphur and nitrogen compounds formed under gasification conditions, there is no proven and cost-efficient method for the removal of such compounds using high-temperature conversion or adsorbents. In the case of ammonia formed from fuel-bound nitrogen, it is often absorbed into acid water, and then has to be treated as a water treatment issue prior to discharge of waste water, alternatively by stripping and recycling to a zone with suitable conditions, e.g. high temperature in the gasifier. The other option also often used under gasification conditions is post-combustion treatment by SNCR or SCR, which are both well-established methods but somewhat reduce the benefits of gasification. For removal of HCN, also produced from fuel bound nitrogen, if required from emission or process considerations, this can be done after the main gas cleaning steps by catalytic hydrogenation simultaneously with COS hydrolysis.

When it comes to sulphur species, notable H<sub>2</sub>S but also COS, as shown in Table 19, there is a variety of methods being used. This also reflects that different methods are applicable at different plant capacities and amounts of sulphur being treated. The use of sulphur sorbents for regenerative systems has been a topic for research for many years mainly in coal gasification, but the technology is not yet really applied industrially. Coal gasification is characterised by very large plant capacities, more reducing gas conditions than for waste gasification, in particular in dry feed coal gasifiers and also typically higher sulphur content in the gas. Therefore, these developments cannot be directly transferred to a waste gasification application without adaptation and cost impacts.

Once-through systems based on zinc oxide or activated carbon are costly and generate secondary wastes that need to be disposed of. The use of alkaline scrubbing is well-established in the coal, oil and gas industries and both for more selective absorption of H<sub>2</sub>S and for simultaneous absorption of H<sub>2</sub>S and CO<sub>2</sub>. However, since the selectivity for H<sub>2</sub>S over CO<sub>2</sub> is limited and there is always a high partial pressure of CO<sub>2</sub> in the gas, the co-absorption of CO<sub>2</sub> is in most cases undesirable due to the unnecessary high chemicals consumption to maintain the pH or a high regeneration energy cost. Even in LOX system, where the design of the gas-liquid contact and the reaction of H<sub>2</sub>S to elemental sulphur enhances the sulphur selectivity, the co-absorption of CO<sub>2</sub> occurs to some extent. LOX systems have been used or considered for use but are costly at the scale of most waste gasification systems. They are also consuming chemicals and generate other by-products in addition to solid sulphur, in addition to being maintenance intensive and more suitable for larger plants.

The use of sodium hypochlorite (although also other oxidants are used) to oxidise sulphide in the water to sulphate prior to the discharge of waste water, is an alternative at smaller capacities. However, the theoretical dosing is over 9 kg/kg S and, furthermore, the presence of ammonia in the water increases the chemicals consumption significantly and can generate undesired by-products.

Reducing the sulphur content more than what is possible by H<sub>2</sub>S removal implies the elimination of COS and organic sulphur compounds. This can be done after the initial gas cleaning and after compression by well-established catalytic methods as the product gas at that point is comparable to other gas streams in refineries and chemical plants.

So, one area for R&D that could result in a huge improvement for waste gasification is a sulphur removal technology that would suit the conditions in terms of the gas composition, sulphur concentration and capacity scale of most waste gasifier. Even if such a method would not be sufficient to remove all sulphur compounds to meet the requirements, bulk removal would make polishing by sorbent or chemical methods already available far easier and less costly. This applies to both power generation and to fuel applications.

Many gasifiers generate a carbon-rich fly-ash where also other contaminants are concentrated. Some processes, such as indirect fluidized beds (e.g. Taylor and Milena) can recycle and oxidize such ashes in the combustion section within the process. For other processes, such ashes are a



significant secondary waste that needs treatment and disposal. Methods for on-site treatment of such ashes, inside the process, or as an add-on to the process could reduce the disposal cost of such material and, overall make the gasification route more comparable to conventional incineration.

Overall, there is not only a need to identify methods that improves the gasifier operation or the cleaning of the gas at laboratory scale, there is also a need to define complete processes and validate gas cleaning concepts at scale that includes the removal of all regulated or end-use process-limited contaminants to ensure that such systems meet the environmental requirements and that any secondary wastes can be disposed of economically. This also includes the evaluation of different methodologies developed to determine the balance between up-front costs for the cleaning process and the O&M costs related to use of materials, utilities and cost of secondary waste disposal.

## **8.2. WASTE GASIFICATION PERFORMANCE**

Thermal treatment, including gasification, in general has advantages over other forms of treatment in that it can convert all combustible waste components. Other treatment methods such as composting and anaerobic digestion are only effective in decomposing biodegradable components such that a secondary residue still containing combustible material can result. However, thermal treatment has limitations for very wet materials (e.g. sludges, etc., that may be easier to handle in e.g. AD systems, unless these can be dried in an economic way). This applies in particular to gasification, as evaporation of water consumes energy that would otherwise be contained as chemical energy in the gas. The highest acceptable moisture content varies depending on the dry fuel energy content and the gasification system and the intended end use of the gas. But, in general terms, fuels with moisture content above 25-30%, reduce the efficiency to a point where drying of the fuel should be considered.

The performance of waste gasification in terms of the conversion efficiency to power, relative to conventional incineration, is clearly higher for "true" gasification systems, due to the steam temperature limitations of incinerators. Likewise, gasifiers of the type two-stage incinerators, i.e. with no or only rudimentary gas cleaning, is subject to the same limitations in terms of steam superheat as incinerators, and hence also have (almost) the same efficiency, typically 20-25 %.

This is due to the fact that for a clean gas, higher steam conditions that are more optimal for power generation are feasible, or due to the fact that other prime movers, ICE, gas turbines, in combination with bottoming cycles can be adopted. This means that it is possible to reach a net efficiency 20-25 % even without a bottoming cycle at a capacity were a comparable, normal incinerator would have lower efficiency. At larger scale, firing clean gas or by introducing a bottoming cycle in addition to the main prime movers, net efficiencies well in excess of 30 % are possible, even if apart from the Kymijärvi II gasifier, no such installation has yet been constructed.

However as can be derived from the economic discussion in Section 8.4, this can be a mixed blessing from an economic perspective unless policies requiring a certain level of efficiency are adopted, or there is some form of incentive pricing for the power generation. Thus, the WFD R1 efficiency concept, and where the factor was raised from 0.60 to 0.65 in 2009, could be such a driver, if raised beyond 0.65 in the future. As can be seen from Table 7, any further increase in the R1 beyond the current 0.65 would make it very difficult for conventional incinerators only producing power to meet such a criteria without raising the steam conditions and have higher costs for the alloy materials and/or maintenance costs. This would favour more efficient technologies such as gasification, but would also favour the use of CHP, and where also incinerators using conventional steam conditions could meet an increase in the R1 factor.

When it comes to the environmental performance, the very stringent limiting emission values required by regulation or adopted for other reasons for incineration technologies in general, and including gasification for power generation, imply that gasification have to accomplish at least the same environmental performance. But since the reduction required in most cases imply a removal of the order of 90 % or more, see Table 14, and since for some contaminants similar type of cleaning technology is used as for incinerators, the potential to go significantly beyond this at reasonable costs is not very well-defined. Therefore, it cannot be said to be superior to incineration in terms of emissions. Furthermore, some of the benefits in terms of air emissions that can be achieved by gasification, in comparison to incineration using dry cleaning without liquid scrubbing, come with the drawback that a process condensate is obtained that needs to undergo further treatment.

Instead, it is the cost of meeting the emission performance that is important, i.e. the equipment and maintenance cost, the use of different material feeds and the possibility for recycling or the cost of the disposal of any secondary residues. Such aspect favoured gasification-melting procedures in Japan as far as the regulations set demands for ash melting.

Even if there dry or semi-dry cleaning using lime and PAC is the state-of-the-art method for gas cleaning, it consumes a significant quantity of lime and generates a significant quantity of residues, where the flue gas cleaning additives are also mixed with ashes from the wastes to which heavy metals have been enriched. Some gasification procedures contribute to this secondary solid residue by also adding unconverted char and soot to this stream, and thereby also adds another step before the final disposal.

However, one could also consider a treatment sequence where high-temperature filtration is used in both gasifiers and incinerators to remove the combustible residues and fly ash including most heavy metals as a concentrated residue, and then do the additional cleaning with e.g. lime or other sorbents for acid removal afterwards such that lime-based gas cleaning residues would not be mixed with fly ash.

It can also be possible to do all cleaning as wet cleaning by scrubbing to remove acid gases, ammonia and sulphur species, and then only use PAC to remove mercury. Even if such wet cleaning would require essentially a tar-free gas to be feasible, LOX treatment to disposable sulphur or oxidation to sulphate in combination with ammonia stripping and recycling would significantly reduce the quantity of secondary residues. Although such schemes have been explored in the projects described in Sections 7.3.2 and 7.4, the feasibility and overall impact in relation to incinerator technologies have not yet been proven.

One performance aspect where gasification technologies are unique in relation to other conventional thermal waste treatment methods is that the product of the treatment can be a chemical or fuel and the treatment can be classified a material recovery and not as energy recovery only when power and/or heat is the output. This has not been seen as very important in the past when reducing volume and avoiding landfills have been the main drivers for thermal treatment. However, as there is an increasing drive towards decarbonisation of the transport system and for biomaterials, this is an area that can be expected to be more and more interesting in the future. The benefits of using wastes have already been recognized in the US RFS2 system and in the recently agreed RED II directive in the EU, the introduction of "recycled carbon fuels" in parallel to "advanced biofuels" means that both the fossil and biogenic part of fuels produced from mixed wastes can be incentivised by the member states.

### 8.3. BARRIERS AND OPPORTUNITIES FOR GASIFICATION

To adopt efficient thermal treatment methods including energy recovery, in the first instance conventional incineration but also other methods, requires a certain development in overall societal waste management system such that wastes are collected in an organised way. It would also require some form of separation of unsuitable material prior to thermal treatment. In addition, waste scavenging for material that is suitable as a fuel may reduce the energy content of the waste considerably, in particular in economies where organic and maybe wet material is more predominant than packaging materials. Unless suitable conditions are at hand, thermal conversion may be challenging in parts of the world where such conditions are lacking, and hence gasification would not be suitable as a means of implementing advanced technologies in waste treatment by frog-leaping over other waste management development stages that are necessary prerequisites as a success factor for advanced thermal treatment.

Another barrier in the shorter term is the development status of conventional incineration technologies. These are proven and mature technologies in terms of performance; there are financially strong suppliers with experience and reference installations that provide guarantees on energy performance, availability and meeting emission and other requirements. This makes incinerators more “bankable” and a safer option for the local decision-makers in e.g. a city council. In the absence of such a track record, gasification and other not so established technologies must prove, or at least make it very likely, that the performance and other conditions at least meet, and preferably go beyond, the conventional technologies by a sufficient margin to motivate selection of such a process, while not generating risks that come back to the decision-makers. There have also been some rather spectacular failures for advanced technologies (Thermoselect projects, Teesside etc.) that also stains advanced technologies in general. But there is also examples of successful use of gasification in e.g. industrial applications such as the Cemex plant in Germany and the Kymijärvi I and II plants (Sections 7.1.1, 7.2.2 and 7.3.2.4, respectively.), that however are lesser known by the public.

However, the use of less well-known technologies can be at least partially off-set by the deep public scepticism or resistance against incinerators, whereby other thermal treatment methods are actively trying to be differentiated from the conventional technology to facilitate gaining public acceptance. In a recent article<sup>669</sup>, the various public and commercial actors in the UK have used anchoring of views and expectations associated with a specific technology to resist or promote different technologies, e.g. by promoting so-called advanced technologies (“true” gasification with high efficiency and improved performance<sup>287, 635</sup>), to generate an association between conventional technologies with advanced technologies (similar performance, two-stage concepts being gasifiers, the superior characteristics of true gasification insufficiently demonstrated<sup>412</sup>) in the case of the established stakeholders, or in the opposite sense (all thermal treatments are more or less equal, gasifiers are incinerators in disguise and the advanced technologies does not deliver on the promises<sup>670</sup>) by those opposed to thermal waste treatment and incinerators in general.

To prove that novel thermal waste treatment technologies can meet and surpass the performance of conventional technology other than on paper requires a reference installation of some reasonable capacity, even if it is not at full commercial capacity. From the descriptions in Section 7 and in particular in Sections 7.3 and 7.4, most developers have spent at least a decade in developing their technologies and pursued many prospect projects to reach first a pilot stage and a then first, prototype demonstrator. To establish such a prototype demonstrator is in itself a large project of

---

<sup>669</sup> Socio-technical change linking expectations and representations: Innovating thermal treatment of municipal solid waste. Les Levidow Paul Upham. *Science and Public Policy*, Volume 44, Issue 2, 1 April 2017, Pages 211–224

<sup>670</sup> <http://ukwin.org.uk/>

minimum several tens of million €. So, disregarding the technology, the developer of any concept must be available to find the means to financing the development cost for a period of many years and where the stakes are escalating rapidly as the market introduction approaches. Most investors have little appetite for so long time-to-market developments in an area subjected to both technical and regulatory risks. The financing of the development, and in particular in the latter stages is a very significant market threshold to become commercial, even if novel technologies and their improvement potential also give opportunities to attract various forms of development financing (grants, loan guarantees, incentive tariffs) that would not become available for mature, conventional technologies.

The drivers for advanced treatment are also important. As will be seen below, the driver of improving efficiency is only a driver when there is a cost of fuel, which is typically not the case for waste. Instead, regarding long-term barriers for adoption of waste gasification, these are related to the policies on waste management and are in many aspects not differing from the impact of such aspects on thermal treatment in general. Examples of policies that would constitute an opportunity are landfill bans or substantial landfill taxes that would transfer waste from landfills to other treatment methods, including thermal treatment.

Another barrier for introducing a new technology such as gasification would be more stringent waste reduction polices and associated targets as well as recycling targets that would be efficient in significantly reducing the combustible fraction in the residual wastes, i.e. the potential waste fuel basis for thermal treatment. This is in particular a barrier in those regions where there is already a surplus of existing incinerator capacity, or where a reduction in the waste fuel potential would shift the balance in the direction of an excess incinerator capacity. An excess of incinerating capacity in existing installations would mean that the economics of the existing plants would see investments as more or less sunk cost and accept lower gate fees than otherwise. Excess capacity and the associated drop in gate fees would therefore become a significant barrier for new investments in any form of treatment technology, and hence an even higher barrier to introducing new technologies such as e.g. gasification.

There are also a number of economic factors that influence the feasibility of a waste gasification project. There has been a general decline in the grid power prices over the last years, partially because of low fossil energy prices and partially due to a rapid increase in renewable power generation (solar, wind, etc.) at low marginal costs. Lower power prices mean a higher need for gate fee revenues and, furthermore, does not provide an incentive for investing in higher efficiency on the basis of the power revenues. In the past, this has been compensated by incentive pricing by e.g. feed-in tariffs, quota systems, etc. to promote the use of renewables and waste in power production. However, there is a general drive within the EU towards more market-based price mechanism also for renewables, and since the fossil part of wastes can be of the order of 30-50 % of the total carbon content, any support for CO<sub>2</sub>-free generation would be reduced as a result. In the EU, there is another cost driver for co-incineration plants, as these require the purchase of emission rights.

In general, there is also a decline in the heat demand in district heating grids as a result of the promotion of energy efficiency and rational use of energy in buildings, as well as from the growing use of heat pumps as power costs are reduced. This could be both an advantage and a disadvantage. In the case of a declining heat demand, technologies such as gasification, that has a higher power/heat ratio could stand to gain. In most cases, the design for waste incinerator CHP heat generation is related to the lower, summer, heat loads as there is a need to operate incinerators even in summer time the impact will be less than from the changes in the electric market. However, as heat revenues are important (see Section 8.4), the overall revenue-generation could go down and affect the project return negatively.

Another strong form of promotional policy driver in line with circular economy principles, is by setting ambitious performance targets for new installations beyond the current state-of-the-art performance, in particular as an efficiency target, and use these as a driver for technology development. The WFD in the EU has initiated this approach by introducing the efficiency factor to qualify as efficient energy recovery. Although this would be technology neutral and stimulate innovations also in the state-of-the-art commercial technologies, this would also require developments and associated costs for these technologies. This would reduce the difference between such technologies and gasification-based technologies, while the potential for higher efficiency in gasification systems would then be seen as more valuable.

Another clear opportunity in line with the circular economy principles is to produce chemicals and fuels such that the reliance on power and heat revenues would be more or less eliminated. The WFD foresees this possibility as a recovery operation under the R3 heading. However, and unlike the R1 criterion, there is no similar criterion that establish a recovery efficiency factor to distinguish between R3 and D10. In addition, and as was noted above, both the RED and the RFS2 systems include promotional aspects for fuels produced from waste via e.g. gasification.

Even so, there has even been a debate within the EU on whether even the biogenic fraction of mixed fossil and biogenic wastes would be accepted as "advanced biofuels" in the RED II. This was finally settled in June 2018 and the biogenic fraction of wastes, with some recycling-related exceptions, is still part of Annex IXa. However, the status of the non-biogenic fraction of the fuel produced, although the "recycled carbon fuel" was defined in RED II, the full requirements regarding the GHG emission threshold required and the associated estimation methodology will only be fully settled in 2021. Furthermore, whether such recycled carbon fuels will be included in the overall member state RE-T target is left to each member state to decide. Therefore, a significant fraction, 30-50 %, of the fuel output may not be receive any benefits in some member states. By comparison, Enerkem has received the US EPA approval to receive D3 (cellulosic ethanol) RINs for their ethanol output if sold in the USA<sup>671</sup>.

#### **8.4. ECONOMICS OF WASTE INCINERATION AND GASIFICATION**

There are few data available in the public domain regarding costs of waste gasification installations with some element of gas cleaning before use of the gas, which is the focus of this report, and the data are mostly reported as lump sums with little explanation as to what is included or not. Furthermore, waste gasification projects are mostly one-off and not comparable to other project with regard to the process and local conditions. This is contrary to waste incinerators, where there are a limited number of proven technologies offered by different suppliers. If there is little detailed information on investments costs, when it comes to O&M costs there is even less public information and mostly based on projections, as long-term operating experience in cases are lacking. Therefore, the discussion below on the economics of waste gasification is based on order of magnitude figures and uses a very simplistic approach, i.e. back-of-envelope estimate level, to highlight the impact of the major cost drivers and revenue streams.

When it comes to cost and performance data for waste incineration and CHP plants, such data can be found in regularly updated reports made by different organisations<sup>672, 673, 674, 675</sup>. The numbers contained in these reports can be generalized to a range of 8 000- 10 000 €/kW<sub>e</sub> net and 10 000-

<sup>671</sup> Enerkem press release, Nov.7, 2017

<sup>672</sup> Cost of Electricity Generation. DEFRA, UK, November 2016.

<sup>673</sup> Technology Data for Energy Plants for Electricity and District heating generation. August 2016. Update 2017 and July 2018. EnergiNet, Danish Energy Agency

<sup>674</sup> El från nya och framtida anläggningar 2014 (Electricity generation from new and future plants). Elforsk rapport 14:40, 2014.

<sup>675</sup> Cost and Performance Characteristics of New Generating Technologies, Annual Energy Outlook 2018. U.S. Energy Information Administration, February 2018

12 000 €/kW<sub>e</sub> net as the installed cost of conventional incinerators for power generation and CHP, respectively, for power outputs in the range of 10-50 MW<sub>e</sub> output capacity. This is far higher than for conventional power generation using coal, biomass or natural gas, where the specific investment is typically in the range 2 000-4 000 €/kW<sub>e</sub>. The difference in the cost for these two configurations predominantly reflects the lower power output for CHP plants but there is also a certain economy of scale effect in the investment. With regard to the O&M cost, most of these sources splits the O&M cost on a fixed annual cost and a variable cost per unit of electricity produced, i.e. there is also an economy of scale effect on the fixed annual cost. For the purpose of this report, this can be further simplified as an annual cost in relation to the investment cost and such figures end up being of the order of approximately 5 % of the investment per year.

When it comes to gasification-based power generation with some level of pre-combustion gas cleaning, the numbers given for different projects in Section 7.3.2 can be equated to an investment magnitude cost of 6 000- 12 000 €/kW<sub>e</sub> net, with one exception, the Lahti II plant that is in the order of 4 000 €/kW<sub>e</sub> only. However, this is also one of the two largest plant, 50 MW<sub>e</sub> gross output, and uses a fuel prepared off-site, such that costs for the fuel preparation is not included in the above investment. It is also interesting to note that the numbers cited for the specific investment for the smallest plant mentioned in Section 7.3.2, Syntech at 1.5 MW<sub>e</sub>, come out very close to the second largest plant, the Teesside plant at 49 MW<sub>e</sub> gross. Furthermore, both plants are also first-of-a kind installations, which has a cost impact. This is in itself, considering that in this span the economy of scale should be reflected, an indication that there is a significant uncertainty in these numbers when used as costs for a generic technology when fully industrially developed. There are no O&M numbers publicly available for gasification plants, so for lack of better information the same 5 % is also assumed to be valid also for gasification plants.

Regarding the production of fuels and chemicals, the numbers cited in Section 7.4 can be equated a magnitude of 4 000-7 000 €/kW fuel output, when also considering a front-end MBT facility. The higher numbers relate to the small GoGreenGas and AMBIGO projects, each at 4 MW fuel input, and both of them having a significant development and demonstration character. The announced projects in Rotterdam and Tarragona involving Enerkem have not been included in judging the above range. The specific investments mentioned for these projects fall far below the cited figures above, but it is not clear if this involves a complete functional plant including fuel pre-treatment and they also seem to have a very high yield, probably from some other element than gasification only, and this high yield reduces the specific investment in a distorting way. The same uncertainty as discussed above is also relevant for fuel production plants costs as very few of these have been built and data available are not well-documented. Again, for lack of better data, the annual O&M cost has been assumed to be 5 % of the investment.

It may seem strange that the more complex waste-to-fuels plants have a lower specific investment cost per unit of output energy than the seemingly more straightforward power or CHP units. However, the efficiency of the waste-to-fuels plants falls into the range of 50-60 %, i.e. approximately twice the efficiency for waste-to power, or more. So, if the specific investment numbers are instead based on the input of the waste fuels, i.e. €/kW<sub>th</sub> fuel input, depending on the efficiency used, the waste-to-power plants come out more or less the same or slightly lower than the waste-to-fuels plants in terms of specific investment. This also means that for a given size of the input, say 200 000 tonnes per year of RDF at 4 MW/tonne energy content, the absolute investment cost figure will not be very different if 25 MW electric power or if instead 50-60 MW fuel is produced, i.e. 150-300 million € for the power plant and 200-420 million € for the fuels, using the numbers above.

For the estimates to follow in Table 40 to Table 45, the lowest and highest specific investment costs have been considered in order to limit the number of columns in the tables below, as any

intermediate can easily be linearly interpolated. But in some tables an intermediate case to facilitate comparisons.

Other data used for the economic estimates are the sales value of the electricity. This has been set to 45 €/MWh<sub>e</sub>, based on the day-ahead wholesale indexed "average" price for power in the EU<sup>676</sup>. This represents the grid value without any incentives for the use of waste or production of RE power.

The value of fuel produced has been set to 90 €/MWh, being a sort of "average" between market prices of the main biofuel competitors, first generation ethanol and biodiesel, and this would presumably be a floor value for producing advanced biofuels.

The gate fee has been set to 50 €/tonne of waste feed, assumed to hold 4 MWh/tonne, i.e. 12.5 €/MWh. The magnitude of the gate fee is what can be found in many places in the EU and elsewhere but does not represent the highest values noted, see also Section 3.1.

For CHP cases the heat credit is assumed to be 30 €/MWh thermal. The plants have been assumed to operate for 8000 hrs per year for both power and CHP cases, as these would be seen as base-load plants, the annual operation period being dictated more than anything else by the need for getting rid of the wastes. For CHP plants a constant total efficiency of 85 % has been considered assuming that the plant is used as base-load at more or less full capacity, for the reasons given above. But, for base-load CHP plant the seasonal low heat load becomes a limitation for the potential capacity of the plant as otherwise the utilization factor is reduced. As an observation, overall efficiency of 85 % to power and heat is also conservative as many waste incinerators use flue gas condensing systems that could bring the total efficiency close to or even above 100 % on an LHV basis.

To translate the specific investment cost to an annual cost for this simplistic estimate, an interest of 8 % over a 20-year lifetime has been assumed, i.e. an annuity factor of 10 %. The economic estimates based on such numbers are shown in Table 40 to Table 45. The tables are organised such that other assumptions are at the top. Costs are counted as positive, i.e. all revenues are denoted as negative, such that a negative total annual cost means that revenues are higher than costs. The zero power and zero gate fee figures, respectively, are the specific sales prices of power per MWh, or gate fee per tonne to achieve a zero-net cost, assuming that the other revenue stream price is unchanged.

For the economic analysis, three limiting scenarios were considered, the first scenario being that the plant is contracted for a certain production of electrical energy (or fuel) per year and can access waste feedstock within reasonable quantities. The second, and probably most likely scenario, is that the installation is either contracted to treat a specified annual amount of waste or have permitting limitations on the treatment capacity. The third scenario only applies to CHP plants, and where the minimum base-load heat output is limiting the design.

#### **8.4.1. Power and CHP Back-of-an-envelope Economics**

The results of the first scenario, i.e. the output of electric power (or fuels) is contractually limited or capped for receiving support, are shown in Table 40 and Table 41. For an incinerator only producing power, Table 40, shows the outcome of this estimate. Data representing conventional technology are on the left-hand side and gasification technologies data, with the potential for higher efficiency,

---

<sup>676</sup> Quarterly Report on European Electricity Markets. Volume 11, issue 1; first quarter of 2018. Directorate-General for Energy, Market Observatory for Energy, 2018.

are shown on the right-hand side. It has also been assumed that that the marginal investment required for an increased efficiency is balanced against the gains from economy-of scale related to the increased plant output, so the specific investment costs used are the ones discussed above.

**Table 40 Back-of-envelope power-only incinerator and gasifier economics, Scenario 1.**

<b>Input values</b>	<b>Incinerator, power</b>				<b>Gasifier, power only</b>					
Specific investment, 1000 €/kW <sub>e</sub>	8	10	8	10	4	8	12	4	8	12
Efficiency, power	20%	20%	25%	25%	30%	30%	30%	35%	30%	35%
Efficiency, heat	0%	0%	0%	0%	0%	0%	0%	0%	0%	0%
<b>Calculated values</b>										
Capital-related, €/MWh <sub>e</sub>	100	125	100	125	50	100	150	50	100	150
O&M, €/MWh <sub>e</sub>	50	63	50	63	25	50	75	25	50	75
<b>Total costs, €/MWh<sub>e</sub></b>	<b>150</b>	<b>188</b>	<b>150</b>	<b>188</b>	<b>75</b>	<b>150</b>	<b>225</b>	<b>75</b>	<b>150</b>	<b>225</b>
Gate fee, €/MWh <sub>e</sub>	-63	-63	-50	-50	-42	-42	-42	-36	-36	-36
Power, €/MWh <sub>e</sub>	-45	-45	-45	-45	-45	-45	-45	-45	-45	-45
<b>Tot. revenues, €/MWh<sub>e</sub></b>	<b>-108</b>	<b>-108</b>	<b>-95</b>	<b>-95</b>	<b>-87</b>	<b>-87</b>	<b>-87</b>	<b>-81</b>	<b>-81</b>	<b>-81</b>
<b>Net cost, €/MWh<sub>e</sub></b>	<b>43</b>	<b>80</b>	<b>55</b>	<b>93</b>	<b>-12</b>	<b>63</b>	<b>138</b>	<b>-6</b>	<b>69</b>	<b>144</b>
Zero net power €/MWh <sub>e</sub>	-88	-125	-100	-138	-33	-108	-183	-39	-114	-189
Zero net gate fee, €/tonne	-84	-114	-105	-143	-36	-126	-216	-42	-147	-252
Annuity factor 10 %, O&M 5 % of investment/year, power revenue 45 €/MWh, gate fee 50 €/tonne, heating value of waste 4 MWh/tonne, heat credit 30 €/MWh, 8 000 annual operating hours assumed.										

The cost assumptions are not sufficient generous to generate a net revenue (i.e. a negative net cost) in Table 40, apart if from a very low specific investment cost is at hand for a gasifier case further discussed below. The gate fee is an important source of revenue for all cases, but if the efficiency increases, the total revenues actually decrease, in particular for the gasification cases as less waste is required to produce the same output.

The decrease in the total revenues can only be compensated by either a low investment cost or a higher power sales or higher gate fees revenues, or a combination of all three. In Table 40, the lowest investment case is based on data for the Kymijärvi II installation (and with the caveat that the MBT facility was not included in this investment cost) and shows a negative net, i.e. the revenues are higher than the costs. From the data it can also be estimated that a gasification-based incinerator at higher efficiency needs to be 10-15 % lower in specific investment compared to the range reported for conventional incinerators to compensate for the lower revenues.

Disregarding the lowest specific investment cost, the increase in the power costs required (for the same 50 €/tonne gate fee) to break even ranges from a factor of 2 to 3. The increase in the gate fee to reach break-even (at the 45 €/MWh<sub>e</sub> power price) in the last two rows of the table must also increase by a factor 2-3.

If instead a CHP plant is considered, Table 41, yet another major product, heat, adds to the revenues. The revenue from heat is by far larger than the value of power sales under the assumptions in this calculation, and also exceeds the revenue from the gate fee. Again, increasing the efficiency to power decreases the total revenue, and also increases the net cost.

In this estimate, both the lowest efficiency and specific investment cost incinerator case (first column) and the case of a CHP gasifier at the lowest specific investment cost (5<sup>th</sup> and 8<sup>th</sup> column,



respectively) have negative net costs, i.e. lower gate fees or power prices could be accepted at break even.

The lowest investment at 4000 €/kWh<sub>e</sub>, representing the Kymijärvi II case, shows an excellent net. However, as noted above, in this case the MBT plant is outside of the investment, and it is not likely that the internal city economics allocate a gate fee for the city-owned energy plant to be paid by the city waste management organisation. Even so, if the gate fee is set to 0, there is still a net revenue (negative net cost) showing that such conditions are robust when a heat revenue is available. This also corroborates the statement by Valmet that the plant is commercial in the sense that it does not require any incentive pricing or subsidy.

**Table 41 Back-of-envelope CHP incinerator and gasifier economics, Scenario 1.**

<b>Input values</b>	<b>Incinerator, CHP</b>				<b>Gasifier, CHP</b>			
Specific investment, €/kW <sub>e</sub>	10 000	12 000	10 000	12 000	4 000	12 000	4 000	12 000
Efficiency, power	20%	20%	25%	25%	25%	25%	30%	30%
Efficiency, heat	65%	65%	60%	60%	60%	60%	60%	60%
<b>Calculated values</b>								
Capital-related, €/MWh <sub>e</sub>	125	150	125	150	50	150	50	150
O&M, €/MWh <sub>e</sub>	<u>63</u>	<u>75</u>	<u>63</u>	<u>75</u>	<u>25</u>	<u>75</u>	<u>25</u>	<u>75</u>
<b>Total costs, €/MWh<sub>e</sub></b>	<b>188</b>	<b>225</b>	<b>188</b>	<b>225</b>	<b>75</b>	<b>225</b>	<b>75</b>	<b>225</b>
Gate fee, €/MWh <sub>e</sub>	-63	-63	-50	-50	-50	-50	-42	-42
Power, €/MWh <sub>e</sub>	-45	-45	-45	-45	-45	-45	-45	-45
Heat, €/MWh <sub>e</sub>	<u>-98</u>	<u>-98</u>	<u>-72</u>	<u>-72</u>	<u>-72</u>	<u>-72</u>	<u>-60</u>	<u>-60</u>
<b>Tot. revenues, €/MWh<sub>e</sub></b>	<b>-205</b>	<b>-205</b>	<b>-167</b>	<b>-167</b>	<b>-167</b>	<b>-167</b>	<b>-147</b>	<b>-147</b>
<b>Net cost, €/MWh<sub>e</sub></b>	<b>-17</b>	<b>20</b>	<b>21</b>	<b>58</b>	<b>-92</b>	<b>58</b>	<b>-72</b>	<b>78</b>
Zero net power €/MWh <sub>e</sub>	-28	-65	-66	-103	47	-103	27	-123
Zero net gate fee, €/tonne	-36	-66	-71	-108	42	-108	36	-144
Annuity factor 10 %, O&M 5 % of investment/year, power revenue 45 €/MWh, gate fee 50 €/tonne, heating value of waste 4 MWh/tonne, heat credit 30 €/MWh, 8 000 annual op. hours assumed.								

A similar case utilizing co-firing into an already existing fossil boiler, would have an even lower investment cost than assumed for the lowest case above, while also have a higher efficiency in the boiler. Such a case could be also be a good application for waste gasification.

Below in Table 42 and Table 43, the corresponding cost-revenue schemes for the second limiting scenario are presented, i.e. the scenario where the annual quantity of waste processed is limited by contractual or permit conditions. In Table 42 the first two columns, at the lowest efficiency to electric energy, remain the same as in Table 41. For comparison, the last row in italics, the net cost row from Table 41, has been added.

Since the revenue from the gate fee is capped as a condition for Scenario 2 and therefore is the same for all columns, increasing the revenue from this lowest case at 20 % means that additional power can be produced and sold, such that an increase in the efficiency also reduce the net cost. When comparing the net cost of Scenario 2 with the Scenario 1, where a higher efficiency increased the net cost, the effect is instead a strong reduction of the net cost for Scenario 2.

When comparing the Scenarios and disregarding the case of the lowest specific investment cost of 4 000 €/kW<sub>e</sub> (the background of which was already discussed above), the net cost is still positive of all other parameter combinations. However, the change required to the power revenue or the gate fee, respectively, to come to break-even is now only a factor ranging from 1.1 to 2.2 to have a, compared to a factor of between 2 and 3 for Scenario 1.

If the values for a specific investment cost of 8 000 €/kW<sub>e</sub> are compared, the net cost goes down from 43 €/MWh<sub>e</sub> over 31 €/MWh<sub>e</sub> and 20 €/MWh<sub>e</sub> to 9 €/MWh<sub>e</sub> as the efficiency is increased from 20 % to 35 % in steps of 5 %. Both the gasifier cases of 30 % and 35 % efficiency, respectively, only require a marginal adjustment of the power sales revenue or the gate fee to break even. The incinerator case at 25 % efficiency would require a gate fee of 75 €/tonne, a number that is in line with actual gate fees in the UK.

**Table 42 Back-of-envelope power-only incinerator and gasifier economics, Scenario 2.**

<b>Input values</b>	<b>Incinerator, power only</b>				<b>Gasifier, power only</b>					
Specific inv., 1000 €/kW <sub>e</sub>	8	10	8	10	4	8	12	4	8	12
Efficiency, power	20%	20%	25%	25%	30%	30%	30%	35%	30%	35%
Efficiency, heat	0%	0%	0%	0%	0%	0%	0%	0%	0%	0%
<b>Calculated values</b>										
Capital-related, €/MWh <sub>e</sub>	100	125	100	125	50	100	150	50	100	150
O&M, €/MWh <sub>e</sub>	50	63	50	63	25	50	75	25	50	75
<b>Total costs, €/MWh<sub>e</sub></b>	<b>150</b>	<b>188</b>	<b>150</b>	<b>188</b>	<b>75</b>	<b>150</b>	<b>225</b>	<b>75</b>	<b>150</b>	<b>225</b>
Gate fee, €/MWh <sub>e</sub>	-63	-63	-63	-63	-63	-63	-63	-63	-63	-63
Power, €/MWh <sub>e</sub>	-45	-45	-56	-56	-68	-68	-68	-79	-79	-79
<b>Tot. revenues €/MWh<sub>e</sub></b>	<b>-108</b>	<b>-108</b>	<b>-119</b>	<b>-119</b>	<b>-130</b>	<b>-130</b>	<b>-130</b>	<b>-141</b>	<b>-141</b>	<b>-141</b>
<b>Net cost, €/MWh<sub>e</sub></b>	<b>43</b>	<b>80</b>	<b>31</b>	<b>69</b>	<b>-55</b>	<b>20</b>	<b>95</b>	<b>-66</b>	<b>9</b>	<b>84</b>
Zero net power €/MWh <sub>e</sub>	-88	-125	-70	-100	8	-58	-108	7	-50	-93
Zero net gate fee,	-84	-114	-75	-105	-6	-66	-126	3	-57	-117
Annuity factor 10 %, O&M 5 % of investment/year, power revenue 45 €/MWh, gate fee 50 €/tonne, heating value of waste 4 MWh/tonne, heat credit 30 €/MWh, 8 000 annual operating hours assumed.										
<i>Net cost, €/MWh<sub>e</sub>, Scenario 1, Table 40</i>	43	80	55	93	-12	63	138	-6	69	144

Looking at the investment cost instead, a power-only gasifier investment cost of around 7 000 €/kW<sub>e</sub> would reach break-even conditions under the cost assumptions made, and generally speaking the higher efficiency would mean that gasifier systems are competitive with conventional incinerators if the same specific investment cost can be realised.

Table 43 shows the result for Scenario 2 for a CHP installation, i.e. where the waste processing is limited. The heat revenue contributes most to the sales revenues, but since power has a higher value per energy unit than heat the net revenues increase with increasing efficiency. This results in that higher revenues are obtained compared to the Scenario 1. It also decreases the gap between the gasification-CHP cases and incineration-CHP at the same specific investment cost, compared to Scenario 1, where the higher efficiency assumed for the former cases actually led to an increased net cost. In Scenario 2, the higher efficiency is beneficial and reduces the cost of the gasifier cases.

**Table 43 Back-of-envelope CHP incinerator and gasifier economics, Scenario 2.**

<b>Input values</b>	<b>Incinerator, CHP</b>				<b>Gasifier, CHP</b>			
Specific investment. €/kW <sub>e</sub>	10 000	12 000	10 000	12 000	4 000	12 000	4 000	12 000
Efficiency, power	20%	20%	25%	25%	25%	25%	30%	30%
Efficiency, heat	65%	65%	60%	60%	60%	60%	55%	55%
<b>Calculated values</b>								
Capital-related, €/MWh <sub>e</sub>	125	150	125	150	50	150	50	150
O&M, €/MWh <sub>e</sub>	<u>63</u>	<u>75</u>	<u>63</u>	<u>75</u>	<u>25</u>	<u>75</u>	<u>25</u>	<u>75</u>
<b>Total costs</b>	<b>188</b>	<b>225</b>	<b>188</b>	<b>225</b>	<b>75</b>	<b>225</b>	<b>75</b>	<b>225</b>
Gate fee, €/MWh <sub>e</sub>	-63	-63	-63	-63	-63	-63	-63	-63
Power, €/MWh <sub>e</sub>	-45	-45	-56	-56	-56	-56	-68	-68
Heat, €/MWh <sub>e</sub>	<u>-98</u>	<u>-98</u>	<u>-90</u>	<u>-90</u>	<u>-90</u>	<u>-90</u>	<u>-83</u>	<u>-83</u>
<b>Total revenues</b>	<b>-206</b>	<b>-206</b>	<b>-209</b>	<b>-209</b>	<b>-209</b>	<b>-209</b>	<b>-213</b>	<b>-213</b>
<b>Net cost, €/MWh<sub>e</sub></b>	<b>-18</b>	<b>20</b>	<b>-21</b>	<b>16</b>	<b>-134</b>	<b>16</b>	<b>-138</b>	<b>13</b>
Zero net power €/MWh <sub>e</sub>	-28	-65	-28	-58	-62	-58	47	-67
Zero net gate fee, €/tonne	-36	-66	-33	-63	57	-63	60	-60
Annuity factor 10 %, O&M 5 % of inv./year, power revenue 45 €/MWh, gate fee 50 €/tonne, heating value of waste 4 MWh/tonne, heat credit 30 €/MWh, 8000 op. hours assumed.								
<i>Net cost, €/MWh<sub>e</sub>, Scenario 1, Table 41</i>	-17	20	21	58	-92	58	-72	78

Below in Table 44, the results for Scenario 3, i.e. when the CHP heat demand is setting the limit.

**Table 44 Back-of-envelope CHP incinerator and gasifier economics, Scenario 3**

<b>Input values</b>	<b>Incinerator, CHP</b>				<b>Gasification incinerator, CHP</b>			
Specific investment, €/kW <sub>e</sub>	10 000	12 000	10 000	12 000	4 000	12 000	4 000	12 000
Efficiency, power	20%	20%	25%	25%	25%	25%	30%	30%
Efficiency, heat	65%	65%	60%	60%	60%	60%	55%	55%
<b>Calculated values</b>								
Capital-related, €/MWh <sub>e</sub>	125	150	125	150	50	150	50	150
O&M, €/MWh <sub>e</sub>	<u>63</u>	<u>75</u>	<u>63</u>	<u>75</u>	<u>25</u>	<u>75</u>	<u>25</u>	<u>75</u>
<b>Total costs, €/MWh<sub>e</sub></b>	<b>188</b>	<b>225</b>	<b>188</b>	<b>225</b>	<b>75</b>	<b>225</b>	<b>75</b>	<b>225</b>
Gate fee, €/MWh <sub>e</sub>	-63	-63	-68	-68	-68	-68	-74	-74
Power, €/MWh <sub>e</sub>	-45	-45	-61	-61	-61	-61	-80	-80
Heat, €/MWh <sub>e</sub>	<u>-98</u>	<u>-98</u>	<u>-98</u>	<u>-98</u>	<u>-98</u>	<u>-98</u>	<u>-98</u>	<u>-98</u>
<b>Tot. revenues, €/MWh<sub>e</sub></b>	<b>-205</b>	<b>-205</b>	<b>-226</b>	<b>-226</b>	<b>-226</b>	<b>-226</b>	<b>-251</b>	<b>-251</b>
<b>Net cost, €/MWh<sub>e</sub></b>	<b>-18</b>	<b>20</b>	<b>-39</b>	<b>-1</b>	<b>-151</b>	<b>-1</b>	<b>-176</b>	<b>-26</b>
Zero net power €/MWh <sub>e</sub>	-28	-65	-16	-44	67	-44	54	-30
Zero net gate fee, €/tonne	-36	-66	-21	-49	62	-49	69	-32
Annuity factor 10 %, O&M 5 % of investment/year, power revenue 45 €/MWh, gate fee 50 €/tonne, heating value of waste 4 MWh/tonne, heat credit 30 €/MWh, 8 000 annual op. hours assumed.								
<i>Net cost, €/MWh<sub>e</sub>, Scenario 2, Table 43</i>	-18	20	-21	16	-134	16	-138	13

Again, the two right-most columns remain the same, and a row in italics with the net cost of Scenario 2 has been added at the bottom. In this scenario, since the base-load heat demand is limiting the output, the revenue from the sales of heat is the same for all cases.

As the sales of heat is the same for all cases in Table 44, an increase in the efficiency to power while maintaining the total efficiency to power and heat, results in a higher power output, but also that more energy input is required as the total output of energy increase, i.e. more wastes can be processed and generate gate fee revenues. In this scenario, 7 out of the 8 cases shows a negative net cost, i.e. the revenues are higher than the costs.

With reference to Scenario 1, where an increase in the efficiency results in that the economics come out less favourable, a recent evaluation of the UK CfD system<sup>677</sup> recognises that there is a trade-off between gate fees and plant efficiency and denotes it as a “perverse incentive”, and the lessons learned is that, since an overall good resource usage should be promoted, a minimum efficiency eligibility requirement should be introduced in the CfD system in the future to counterbalance this effect.

Furthermore, as can be seen above, in most cases for power-only or CHP incinerators, both conventional and gasification-based, the assumptions on the cost elements used are not sufficient to give revenues meeting the costs that are linked to the specific investments. Nevertheless, if the efficiency increase possible via waste gasification technologies is valued, the investment cost of a gasifier can be similar in magnitude to a conventional incinerator and still come out better in terms of the simplified economics above. But, as discussed above, while the magnitude of the specific investment cost of conventional waste incinerators are known, there is less data available for gasifiers, and these mainly represent first-of-a-kind installations with limited operational track record.

However, the use of waste fuel to produce power and CHP power typically benefits from some form of incentive or can charge higher gate fees, irrespective of the technology used. In Japan there is both grant support of 25 % or more available in combination with financial support that effectively reduce the plant owner investment, i.e. reduces the effective specific investment cost. In the UK, and for plants coming into operation up to March 31, 2017, the Renewable Obligation Order awarded waste gasification plants 2 ROCs/MWh<sub>e</sub> for waste gasification plants. ROCs have traded in the 35-50 £/ROC range in recent years, i.e. a compensation making a lot of difference to the net cost numbers in Table 40 or Table 41.

The current UK auctioning scheme for supporting technology developments in renewable energy, including waste conversion by advanced technologies, uses a guarantee price (strike price) via a so-called Contract for Differences (CfD). For advanced waste treatment, the first auction in 2015 gave 140 €/MWh<sub>e</sub> and 90 €/MWh<sub>e</sub> in 2017 (converted from a common 2017 GBP value)<sup>678</sup>, i.e. far higher than the 45 €/MWh assumed in the above calculations.

For the Morcenx first-of-a-kind plant, See Section 7.3.2.2, the effective PPA value was 150 €/MWh<sub>e</sub>, while the original investment was approximately 8 000 €/kW<sub>e</sub> net, which would result in feasible conditions. The CHP situation is more favourable when applicable and in particular Scenario 3 is very favourable, if the heat demand and the waste availability conditions are present.

---

<sup>677</sup> Contracts for Difference Scheme for Renewable Electricity Generation. Government response to consultation on proposed amendments to the scheme Part B & Follow-up consultation on implementation, contract changes, and a revised CHPQA standard. Department for Business, Energy & Business Strategy, UK. August 2018.

<sup>678</sup> UK unveils CfD winners. Ends Waste & Bioenergy, 11 September 2017

But, in any case, from a policy perspective, support schemes should always be combined with a minimum efficiency requirement to foster good resource utilisation, in particular when support is linked to a specified annual energy production or if the gate fees is the dominating revenue stream.

#### 8.4.2. Fuel Production Back-of-an-envelope Economics

The production of fuels, under the assumption of a fixed output such as in Scenario 1, results in a situation similar to the one in Table 40, i.e. there are two revenue streams and when efficiency goes down, the revenue goes down, such that this case is not so interesting to analyse. Table 45, represents the results for fuel production under Scenario 2, i.e. with a fixed annual waste quantity by contract or by permit.

In this case, the relation between cost and revenues is more balanced compared to the power only cases in Table 40 and Table 42. This balance can be ascribed to three factors, the lower investment cost per output of fuel (although in absolute terms the plant can be similar in investment or even higher than an incinerator processing the same waste quantity, as discussed above. A specific investment of 4 000 €/kW<sub>fuel</sub> at an efficiency of 50 % corresponds to 8 000 €/kW<sub>e</sub> at 25 % efficiency), the high efficiency that gives more sellable product per unit of waste feedstock and the higher unit selling price of this product, relative to the power and heat prices used here.

**Table 45 Back-of-envelope waste-to-fuel plant economics, Scenario 2**

Input values	Fuel					
Specific investment €/kW <sub>fuel</sub>	4000	5500	7000	4000	5500	7000
Efficiency, fuel	50%	50%	50%	60%	60%	60%
Efficiency, heat	0%	0%	0%	0%	0%	0%
<b>Calculated values</b>						
Capital-related, €/MWh <sub>fuel</sub>	50	69	88	50	69	88
O&M, €/MWh <sub>fuel</sub>	25	34	44	25	34	44
<b>Total costs</b>	<b>75</b>	<b>103</b>	<b>131</b>	<b>75</b>	<b>103</b>	<b>131</b>
Gate fee, €/MWh <sub>fuel</sub>	-25	-25	-25	-25	-25	-25
Fuel, €/MWh <sub>fuel</sub>	<u>-85</u>	<u>-85</u>	<u>-85</u>	<u>-102</u>	<u>-102</u>	<u>-102</u>
<b>Total revenues</b>	<b>-110</b>	<b>-110</b>	<b>-110</b>	<b>-127</b>	<b>-127</b>	<b>-127</b>
<b>Net, €/MWh<sub>fuel</sub></b>	<b>-35</b>	<b>-7</b>	<b>21</b>	<b>-52</b>	<b>-24</b>	<b>4</b>
Zero net fuel, €/MWh <sub>fuel</sub>	-65	-99	-133	-42	-65	-89
Zero net gate fee, €/tonne	-10	-78	-145	54	-2	-59
Annuity factor 10 %, O&M 5 % of inv./year, gate fee 50 €/tonne, heating value of waste 4MWh/tonne, fuel credit 85 €/MWh, 8 000 op. hours assumed.						

At the high efficiency that can be expected, the contribution from fuel sales is by far the major revenue generator and hence the dependency of the gate fee is not as large as for power generation. For the lower investment cost, this estimate indicates feasible conditions, while even for higher investment cost, the additional incentive or rise in the gate fee per tonne required to become feasible is smaller than for e.g. the power only cases in Table 40 and Table 42.

As an example, the Fulcrum project, see Section 7.4.2.4, claims to have zero cost fuel, i.e. have no gate fee. The operation of the waste pre-treatment facility is covered by the gate fee for the untreated MSW received and the value of recyclables recovered and sold. From the publicised numbers an investment cost in the region of 4 000- 4 500 €/kW fuel product can be concluded. At

this lower investment cost, a low gate fee would still make it possible to more or less be at break even. So, from these simplistic economics, fuel production looks very attractive and there are a number of companies pursuing this pathway at various stages in development.

## 9. Conclusions

The quantities of wastes that could be treated by thermal methods is huge and globally amounts to many hundreds of millions of tonnes, if not over thousand million tonnes, annually, some of which is already processed in incinerators but still a very considerable fraction is disposed of in landfills.

The state-of-the-art thermal treatment technology is waste incineration with energy recovery. There are of the order of some two thousand such installation world-wide. However, due to the presence of contaminants in wastes, notably chlorine, corrosion issues limit the feasible steam superheat temperatures, while the scale of operation is smaller than for other solid-firing thermal power plants with more sophisticated steam cycles. Therefore, the efficiency to power of waste incinerators are significantly lower than in thermal power plants using other fuels.

The use of waste gasification technologies has the potential to increase the efficiency to power. In addition, waste gasification can also be used not only for energy recovery but also to produce fuels, i.e. material recovery. Both these options are however linked to that the product gas from the gasifier is subjected to a more or less extensive cleaning in several stages before it is combusted or used for synthesis of fuels.

Despite this potential for high efficiency or fuel production most applications for gasification in a large number of plants, predominantly in Japan and the UK, utilize some form of close-coupled downstream combustion equipment, a boiler or furnace, without any, or with only some rudimentary gas cleaning. Such installations can use the gas as a fuel or supplementary fuel in industrial kiln e.g. in the cement industry, there is a long-term experience at one such plant in Germany, and several such plants are in operation in China using Japanese gasification technology.

However, when the gasification system is designed such that the gas generated is used for power production by being combusted directly in a close-coupled boiler or furnace with a downstream heat recovery steam generator, the efficiency to power has the same limitations of the steam conditions as an incinerator. The efficiency of such installations is therefore similar or slightly inferior to a comparable waste incinerator. There are around one hundred such installations in operation, mainly in Japan but also in the UK. Although such conversion systems are often referred to as gasifiers, such units can equally well be termed two-stage incinerators as the potential benefits of gasification systems with gas cleaning are not exploited.

The driver for such systems in Japan was a legal requirement for a period of time for the vitrification of the ashes from waste incineration. Using gasification systems with integrated ash vitrification, this requirement can be fulfilled without external fuel or power consumption, which would not be the case for a separate vitrification. Instead, some of the fuel energy is consumed to reach the vitrification temperature and for the vitrification process, that could otherwise have been used for raising steam and subsequently be result in more power generation. In most cases, the remaining gas is combusted directly without any pre-combustion gas cleaning. These gasification technologies are still being installed by some suppliers, but ash vitrification is since a decade no longer mandated. The need for power from non-nuclear sources in Japan has instead shifted the focus from this type of gasification installations towards promotion of higher electrical output and conventional incineration. Although incinerator ash is a problematic secondary residue which could be addressed by vitrification, it has not been a strict requirement for ashes from ordinary MSW or RDF

installations outside of Japan such that the use of these type of systems have been limited elsewhere. However, developers of plasma gasification such as AlterNRG, APP and CHOPower promotes this as an additional advantage of their gasification concepts.

In the UK, the driver has been the support system for renewable power and an ambition to support improvements in the thermal treatment of waste. The support system gave specific incentives to gasification technologies defined in such a way that the requirements were met already by an installation with a physical separation between the gasifier and the combustor/boiler and where a certain gas heating value could be measured in between these sections.

As for individual suppliers, the main suppliers in terms of their number of references for these kinds of two-stage incinerators are Japanese companies such as Nippon Steel & Sumikin Engineering, Ebara, JFE, Kawasaki and Kobelco etc., and then most often in conjunction with ash vitrification. In Europe, and with far less references than the main Japanese suppliers, Norwegian Energos was quite successful for a period of time and now companies like Biomass Engineering and Eqtec appears to be strong on the UK market, but there are also others. In terms of companies from North America, AlterNRG also has some references while, more recently, also Outotec and Nexterra have been selected for the supply of plants mainly in the UK.

In parallel, there have for a long time been developments that includes cleaning of the waste gasification product gas, "true gasification" systems, to enable its use in more efficient power cycles than used in the conventional incineration technology, or for producing fuels. Several such developments are described in the report, but these have not come to the technical maturity of conventional incinerators or gasification system using the two-stage incineration approach. At present, there are a few plants either using an efficient steam cycle (Valmet), or at lower capacity, ICE engines (CHOPower, Sierra Energy and others). There are yet some other developers in various stages of planning (LLT, Syntech and others), and where e.g. Synova and Taylor Bioenergy are also developing its gasification system to feed the gas into gas turbine combined cycles. For fuel products, there is at present only one such commercial plant in operation in Canada, using Enerkem technology to produce ethanol. In addition, there is also one plant in early construction phase in the USA, Fulcrum Sierra Biofuels where FT liquids will be produced, and yet another at a smaller demonstration scale is in commissioning, the GoGreenGas bio-methane demonstration plant in the UK. Appendices 3 and 4 includes a listing of some 80 waste gasification developers and some 300 plants and projects in planning/development identified during the course of this work, a listing that may still be lacking several entries for developers and projects.

There is a wide variety of gasifier types in use; grates, shaft furnaces, fluidized beds etc. Many of these generic equipment/reactor types are also being used for conventional incineration. There is no real difference between the generic gasifier types used for two-stage incineration and concepts involving gas cleaning, except that for the latter concepts involving gas cleaning, indirect gasifiers, typically fluidized beds, are also used in addition to the direct gasification systems. This is explained by the fact that the gas cleaning is mainly taking place downstream of the gasifier such that for the gasification stage itself, there is limited differences between two-stage incineration and true gasification systems for direct gasifiers. Indirect gasifiers, where the process is divided between a gasification and combustion reactor, are less relevant when the gas is burned directly.

The gas cleaning requirements for waste gasification, which is the centrepiece in realising both the efficiency and the flexibility potential of the technology, differs from conventional waste incineration in the sense that for this latter technology the control technology needs to meet limits in a number of regulated emissions at the exhaust stack. For advanced gasification systems, gas cleaning operations are necessary to, first, meet the requirements to enable the use of the gas in engines, gas turbines and efficient steam cycles as well as for the synthesis of material energy carriers:

Secondly, in the case of power production, where the cleaned gas is consumed in boilers, engines or gas turbines, the exhaust gas from these are then also being subject to the same limiting stack emission requirements as an incinerator.

When considering the gas cleaning before the gas is used, in particular hydrocarbons in the form tars are present in the gasifier exit in high concentration, whereas in an incinerator such compounds are efficiently combusted to meet the level of regulated emission. The presence of tars in the concentrations at hand in most gasifiers makes it a primary target for cleaning, as tars interfere with heat recovery via gas cooling and cleaning addressing other contaminants.

The primary method for removal of tars in waste gasification systems is by thermal decomposition at elevated temperatures relative to the bulk of the gasifier. This can be accomplished in some section inside of the gasifier itself, but more commonly is to have a separate unit for this purpose downstream of the gasifier. The increase in the temperature above the gasifier temperature is achieved by the use of additional oxidant, air or oxygen, and in some cases also in combination with plasma torches. Another less common way to remove tars used is by scrubbing with a suitable liquid to absorb tar hydrocarbons.

Other gasification specific issues are that sulphur compounds are present in a different chemical form than in an incinerator and the formation of ammonia and predominantly  $\text{NH}_3$  from fuel bound nitrogen. In the case of sulphur present in the waste fuel, it is not oxidized to primarily  $\text{SO}_2$  as in an incinerator, and then captured by well-proven cleaning technologies for this species. In a raw gasifier product gas sulphur is present predominantly as  $\text{H}_2\text{S}$  but also  $\text{COS}$  and organic sulphur compounds which are more difficult to remove. Pre-combustion gas cleaning technologies therefore rely on the adoption and adaption of technologies used in other industries e.g. chemical, oil and gas industries and a variety of technologies are being used to suit different conditions, e.g. plant capacity and end use requirements. This is an area where in particular research could assist in improving the outlook for waste gasification by providing suitable and cost-efficient cleaning methods. Ammonia, which is largely converted  $\text{NO}$  when the gas is burnt or is undesirable when the gas is used for synthesis of other fuels, can be removed by scrubbing and dealt with by water cleaning. Alternatively, if a combustion process is used where ammonia is oxidized to  $\text{NO}_x$ , there is also the opportunity to use established post-combustion de- $\text{NO}_x$  technologies.

Other contaminants are removed by cleaning technologies that are similar to what is used in incineration processes and other industries, and therefore the adaption of these to suit gasification conditions does not constitute a similar technical barrier as tars and sulphur cleaning.

However, in terms of environmental performance, the EU and other legislation for incinerators imply that the regulated contaminants must be removed to an extent of 90-95 %, or more, in relation to their presence in typical waste fuels and other jurisdictions have similar official or unofficial requirements. In the EU, a waste gasifier producing power and heat would also fall under the definition of an incinerator, and the exhaust gas would be subject to the same regulations. At this required high level of cleaning it is difficult to claim that gasification systems, where, can drastically reduce the emissions. For the purpose of chemical synthesis, the gas cleaning requirements are even higher in relative terms.

The benefit of waste gasification relative to incineration, in addition to the potential for higher efficiency to power and the possibility to produce e.g. liquid fuels, could instead lie in that the gas volume to be cleaned by pre-combustion cleaning is one only 30-50 % of the gas volume to be subjected to post-combustion cleaning and therefore be lower in cost. Using pre-combustion cleaning, secondary gas cleaning wastes could be reduced or more or less avoided by producing e.g. sulphur instead of producing contaminated gypsum and other by-products. This could reduce the



cost of disposal of such materials and also reduce the material intensity of the waste processing procedures.

Nevertheless, and as is described in the report, there have not been many plants in which waste gasification in combination with a more extensive gas cleaning have been used, and some of these have not been very successful for various reasons, such that the accumulated experience from such installations are not sufficient to validate if there are substantial performance and environmental advantages of waste gasification systems over conventional incineration technologies.

There has been a wide variety of gasification and gas cleaning technologies used. This is in itself a sign that the technology is not mature and concentrated to a smaller number of varieties that have proven to be more cost-efficient and reliable than other options tried. When it comes to projects including gas cleaning, Thermoselect has the longest list of actual projects but also associated with various issues that limits the presence of this technology on the market in recent years. It is noticeable that the plants built by the licensee JFE in Japan appears to have performed better than plants elsewhere, possibly because the licensee could deploy more resources to overcome teething problems than the original developers had. AlterNRG have also had a few plants but with mixed results, and the withdrawal of Air Products from the Tees Valley projects in 2016 has cast some shadows on this technology. Other developers have succeeded in establishing projects of some significant capacity from a commercialisation perspective and are engaged in getting these plants operational to be used as a reference when marketing their technology. Even a resourceful company as Valmet with the Kymijärvi II plant in regular operation for 5 years have not been successful in selling a second unit.

Considering the economics, waste incinerators and also waste gasification units have higher specific investment cost and also lower conversion efficiencies to power than conventional thermal power plants. For both conventional and gasification-based systems, a simplistic evaluation of economics using the average market conditions without any incentives, the figures do not show good economic results if only seen as a power plant project with an opportunity fuel. The revenues from selling power to the grid, and also heat if in a CHP environment, at these conditions are not sufficient to cover the capital-related and operating. To reach break-even the economy is relying on combinations of monetized additional societal services in waste treatment gate fees and supports such as e.g. investments subsidies and financing assistance, as in Japan, or an incentivized mark-up of the power price (FiT, sellable certificates etc.). Under the assumptions made, the major cost driver is the capital-related costs. The gate-fee is a large contributor to the revenue stream for power-only plants and together with heat sales a very significant part of the revenues for CHP systems. This also means that the link between efficiency to produce power, within the boundaries of the total efficiency to heat and power in a CHP plant, is weaker than for other types of thermal power plants.

The economic potential for advanced gasification for power or CHP plants lies in a combination of similar or lower investments compared to conventional incineration at the capacity band targeted and the higher efficiency compared to a conventional incinerator. Despite the uncertainty, the data seem to indicate that there is such a window in investment cost. However, there are really too few installations and too little operating experience to establish any more precise generic cost band. The increased efficiency associated with advanced gasification and gas cleaning technologies in itself does not necessarily results in that such developments are pursued, considering the high development cost and the long time-to-market, and where high gate fees does not provide incentives to increase the conversion efficiency by investing in more advanced technologies. Therefore, policies that sets minimum demands for the conversion efficiency to power to have permits or for obtaining economic incentives favour and promote higher efficiency processes. If such policies are implemented, gasification and gas cleaning technologies would be a strong contender,

while the more established conventional incineration technology would also require development to meet such demands.

The points above relate to the production of mainly power and to some degree also to power and heat in CHP installation. By comparison, the economy of producing renewable fuels looks from this perspective very favourable. There is no other waste technology that competes with this value chain such that the gasification technology develops as a new value chain for this type of product, not as a replacement of a well-established conventional technology. This is a result of several factors. The energetic efficiency is high, which both reduces the specific investment cost related to the energetic output of the product (even if the specific investment in terms of investment cost per input energy unit is more or less the same as for a conventional incinerator) and results in an output of more product per tonne of waste. Furthermore, the sales value of this fuel product is higher than for power or heat on an energy basis. The back of the envelope estimates indicate that the level of support and subsidies required to break-even for this case can be nil or in any case at least be significantly lower than for most power generation and CHP cases.

Waste gasification with gas cleaning have been struggling for decades in the power and CHP markets without really catching on with, a few exceptions in markets where regulatory or market interventions by incentives have been introduced. The thermal conversion of waste to produce fuels may well be the niche where the break-through for waste gasification technologies will come. Fuels from the biogenic fraction of the carbon in the waste has been recognised as advanced biofuels for quite some time but also so-called recycled carbon fuels meeting sustainability boundaries are now also being acknowledged as replacement virgin fossil fuels.

So, what can be concluded on the outlook for waste gasification technologies, and then again limiting the discussion to systems involving gas cleaning and to developers and concepts that have been more actively pursued in recent years. It is clear that this is a technology still in development and where a number of first-of-a-kind installations are in early operation, commissioning, construction or in later stages of planning, so both performance and costs are still uncertain or unproven. To move such projects to financial closure and to second or third installations, there needs to be an incitement for the developers and investors to engage in a technically and non-technically risky development that stretches over several years or even a decade before being established on the market.

Policy interventions to limit or decrease the direct disposal of waste, such as landfill bans, restrictions, and taxation, promote recycling and thermal treatment of residual wastes in general. However, the competitive situation between well-established waste incineration technologies and the emerging gasification technology, such measures on their own may not be sufficient to promote gasification. In this case, subsidies, incentives and grants directed towards new technologies can to some extent even out such a difference and steer developments.

Another strong form of policy driver is by, and in line with circular economy principles, setting ambitious performance targets for new installations, in particularly as an efficiency target, and use these as a driver for technology development. Although this would be technology neutral and stimulate innovations also in the state-of-the-art commercial technologies, this would also require developments and associated costs for conventional technologies, while the potential for higher efficiency in gasification systems would then be seen as more valuable.

Similar to setting performance targets, promotion of renewable fuels production from waste would side-step the main conventional incineration competitor and directly stimulate development of the few technically feasible pathways, including gasification, that can utilize wastes to provide such fuels. This may be the most interesting and feasible application for waste gasification in the future.

## Appendices

### Appendix 1 – Waste and SRF standards

**Table A1.1 CEN/TC292 standards and other outputs**

CEN/TR 15310-1:2006	Characterization of waste-Sampling of waste materials- Part 1: Guidance on selection and application of criteria for sampling under various conditions
CEN/TR 15310-2:2006	Characterization of waste - Sampling of waste materials - Part 2: Guidance on sampling techniques
CEN/TR 15310-3:2006	Characterization of waste - Sampling of waste materials - Part 3: Guidance on procedures for sub-sampling in the field
CEN/TR 15310-4:2006	Characterization of waste - Sampling of waste materials - Part 4: Guidance on procedures for sample packaging, storage, preservation, transport and delivery
CEN/TR 15310-5:2006	Characterization of waste - Sampling of waste materials - Part 5: Guidance on the process of defining the sampling plan
CEN/TR 16130:2011	Characterization of waste - On-site verification
EN 13965-2:2010	Characterization of waste - Terminology - Part 2: Management related terms and definitions
EN 14899:2005	Characterization of waste - Sampling of waste materials - Framework for the preparation and application of a Sampling Plan
EN 16457:2014	Characterization of waste - Framework for the preparation and application of a testing programme - Objectives, planning and report

**Table 2 CEN TC43 recommendations, specifications and standards<sup>679</sup>**

CEN/TR 15404:2010	Solid recovered fuels - Methods for the determination of ash melting behaviour by using characteristic temperatures
CEN/TR 15441:2006	Solid recovered fuels - Guidelines on occupational health aspects
CEN/TR 15508:2006	Key properties on solid recovered fuels to be used for establishing a classification system
CEN/TR 15591:2007	Solid recovered fuels - Determination of the biomass content based on the 14C method
CEN/TR 15716:2008	Solid recovered fuels - Determination of combustion behaviour
CEN/TS 15401:2010	Solid recovered fuels - Determination of bulk density
CEN/TS 15405:2010	Solid recovered fuels - Determination of density of pellets and briquettes
CEN/TS 15406:2010	Solid recovered fuels - Determination of bridging properties of bulk material
CEN/TS 15412:2010)	Solid recovered fuels - Methods for the determination of metallic aluminium
CEN/TS 15414-1:2010	Solid recovered fuels - Determination of moisture content using the oven dry method - Part 1: Determination of total moisture by a reference method

<sup>679</sup>[https://standards.cen.eu/dyn/www/f?p=204:7:0:::FSP\\_ORG\\_ID:407430&cs=149459C8162DDED070B30C74A5A6F058B](https://standards.cen.eu/dyn/www/f?p=204:7:0:::FSP_ORG_ID:407430&cs=149459C8162DDED070B30C74A5A6F058B)

**Table A1.2 CEN TC43 recommendations, specifications and standards, continued**

CEN/TS 15414-2:2010	Solid recovered fuels - Determination of moisture content using the oven dry method - Part 2: Determination of total moisture content by a simplified method
CEN/TS 15639:2010	Solid recovered fuels - Determination of mechanical durability of pellets
EN 15357:2011	Solid recovered fuels - Terminology, definitions and descriptions
EN 15358:2011	Solid recovered fuels - Quality management systems - Particular requirements for their application to the production of solid recovered fuels
EN 15359:2011	Solid recovered fuels - Specifications and classes
EN 15400:2011	Solid recovered fuels - Determination of calorific value
EN 15402:2011	Solid recovered fuels - Determination of the content of volatile matter
EN 15403:2011	Solid recovered fuels - Determination of ash content
EN 15407:2011	Solid recovered fuels - Methods for the determination of carbon (C), hydrogen (H) and nitrogen (N) content
EN 15408:2011	Solid recovered fuels - Methods for the determination of sulphur (S), chlorine (Cl), fluorine (F) and bromine (Br) content
EN 15410:2011	Solid recovered fuels - Methods for the determination of the content of major elements (Al, Ca, Fe, K, Mg, Na, P, Si, Ti)
EN 15411:2011	Solid recovered fuels - Methods for the determination of the content of trace elements (As, Ba, Be, Cd, Co, Cr, Cu, Hg, Mo, Mn, Ni, Pb, Sb, Se, Tl, V and Zn)
EN 15413:2011	Solid recovered fuels - Methods for the preparation of the test sample from the laboratory sample
EN 15414-3:2011	Solid recovered fuels - Determination of moisture content using the oven dry method - Part 3: Moisture in general analysis sample
EN 15415-1:2011	Solid recovered fuels - Determination of particle size distribution - Part 1: Screen method for small dimension particles
EN 15415-2:2012 (	Solid recovered fuels - Determination of particle size distribution - Part 2: Maximum projected length method (manual) for large dimension particles
EN 15415-3:2012	Solid recovered fuels - Determination of particle size distribution - Part 3: Method by image analysis for large dimension particles
EN 15440:2011	Solid recovered fuels - Methods for the determination of biomass content
EN 15440:2011/AC:2011	Solid recovered fuels - Methods for the determination of biomass content
EN 15442:2011	Solid recovered fuels - Methods for sampling
EN 15443:2011	Solid recovered fuels - Methods for the preparation of the laboratory sample
EN 15590:2011	Solid recovered fuels - Determination of the current rate of aerobic microbial activity using the real dynamic respiration index

**Table A1.3 ISO TC 300 Solid recovered fuels standards under development**

ISO/AWI 21637	Solid recovered fuels -- Terminology, definitions and descriptions
ISO/CD 21640	Solid recovered fuels -- Specifications and classes
ISO/AWI 21644	Solid recovered fuels -- Method for the determination of biomass content
ISO/AWI 21645	Solid recovered fuels -- Methods for sampling
ISO/CD 21654	Solid recovered fuels -- Determination of calorific value
ISO/CD 21656	Solid recovered fuels -- Determination of ash content
ISO/CD 21660-3	Solid recovered fuels -- Determination of moisture content using the oven dry method -- Part 3: Moisture in general analysis sample
ISO/AWI 21663	Solid recovered fuels -- Methods for the determination of carbon (C), hydrogen (H), nitrogen (N) and sulphur (S) by the instrumental method
ISO/AWI 21911	Solid recovered fuels -- Determination of self-heating
ISO/AWI 21912	Solid recovered fuels -- Safe handling and storage of solid recovered fuels
ISO/AWI TR 21916	Solid recovered fuels -- Guidance for specification of solid recovered fuels (SRF) for selected uses
ISO/AWI 22105	Solid recovered fuels -- Determination of the total Sulphur content using a high temperature tube furnace combustion method -- IR-detection
ISO/CD 22167	Solid recovered fuels -- Determination of content of volatile matter
ISO/AWI TS 22940	Solid recovered fuels -- Determination of elemental composition by X-ray fluorescence

## Appendix 2 – Limiting Emission Values 2016

### EU EMISSION LIMITS (EID, MCP DIRECTIVES)

The EID directive LEVs apply to plants above 50 MW thermal and waste incinerators above 3 tonnes/hr. The LCP directive LEVS applies or will apply to plants from 1 to 50 MW thermal.

**Table A2.1 Emission limit values (mg/Nm<sup>3</sup> dry gas) for biomass-fired LCPs**

Limiting emission values for selected LCPs	SO <sub>2</sub>	Dust	NO <sub>x</sub>	CO
Biomass @ dry gas 6 % O <sub>2</sub> 50-100 MW	200	20	250	100
100-300 MW,	200	20	200	100
> 300 MW	150	20	150	100
Combustion plants other than gas turbines and gas engines at 3% O <sub>2</sub>	35	5	100	100
Gas turbines (including CCGT) above 70 % load at 15% O <sub>2</sub> ,			50 <sup>1</sup>	100
Gas engines at 15% O <sub>2</sub>			75	100

(1) Increased by proportioning GTs with single cycle efficiency above 35 %

**Table A2.2 Emission limit values for waste incinerators**

Limiting emission values. All values are referred to dry gas at 11% O <sub>2</sub> to which any measurements should be recalculated.	Daily average, (mg/Nm <sup>3</sup> dry gas)	Half-hourly average, (mg/Nm <sup>3</sup> dry gas) are of all measurements below indicated value	
		(100%) A	(97%) B
Total dust	10	30	10
Total organic carbon (TOC)	10	20	10
Hydrogen chloride (HCl)	10	60	10
Hydrogen fluoride (HF)	1	4	2
Sulphur dioxide (SO <sub>2</sub> )	50	200	50
Nitrogen monoxide (NO) and nitrogen dioxide (NO <sub>2</sub> ), expressed as NO <sub>2</sub>	200 (400 below 6 ton/hr.)	400	20
Emission limit values (mg/Nm <sup>3</sup> ) for CO:	Daily average	Half-hourly average	10-minute average
	50	100 (150 fluid beds)	150
Average emission limit values (mg/Nm <sup>3</sup> dry gas) for the following heavy metals over a sampling period of a minimum of 30 minutes and a maximum of 8 hours			
Cadmium and its compounds, expressed as cadmium (Cd)	Total = 0.05		
Thallium and its compounds, expressed as thallium (Tl)			
Mercury and its compounds, expressed as mercury (Hg)	0.05		
Antimony and its compounds, expressed as antimony (Sb)	Total = 0.5		
Arsenic and its compounds, expressed as arsenic (As)			
Lead and its compounds, expressed as lead (Pb)			
Chromium and its compounds, expressed as chromium (Cr)			
Cobalt and its compounds, expressed as cobalt (Co)			
Copper and its compounds, expressed as copper (Cu)			
Manganese and its compounds, expressed as manganese (Mn)			
Nickel and its compounds, expressed as nickel (Ni)			
Vanadium and its compounds, expressed as vanadium (V)	0,1		
Average emission limit value (ng/Nm <sup>3</sup> ) for dioxins and furans over a sampling period of a min. of 6 h and a max. of 8 h			

The MCP directive gives limiting emission values for combustion plants in the range 1 to 20 MW thermal.

**Table A2.3 Emission limit values (mg/Nm<sup>3</sup> dry gas) for biomass-fired MCPs**

Pollutant in mg/Nm <sup>3</sup>	Solid biomass @ 6 %O <sub>2</sub>	Gas fuels other than natural gas @ 3 % O <sub>2</sub>
SO <sub>2</sub>	200(1)	35**, 100
NO <sub>x</sub>	300 (500 < 5 MW)	200
Dust	20 50 < 5 MW, 30 5-20 MW)	

\* Does not apply for solid wood.

\*\* (400 for coke oven gas and 200 for blast furnace gas in steel industries, 100 for biogas)

**Table A2.4 Emission limit values (mg/Nm<sup>3</sup> dry gas) for gas-fired MCPs**

Pollutant in mg/Nm <sup>3</sup>	Type of MCP	Gas fuel other than natural gas @ 15 % O <sub>2</sub>
SO <sub>2</sub>	Engines and gas turbines	15
NO <sub>x</sub>	Engines	190
	Gas turbines above 70 % load	200
Dust	Engines and gas turbines	

## JAPANESE EMISSION LIMITS

The limits below are based on the 1993 Environmental Act and the 1998 Law Concerning Special Measures against Dioxins, including amendments. A revision of these was initiated in 2014.

**Table A2.5 Japanese boiler LEVs<sup>680</sup>**

mg/Nm <sup>3</sup> dry gas Type of installation	Flue gas capacity 1 000 Nm <sup>3</sup> /h	SO <sub>x</sub> mg/Nm <sup>3</sup>	Dust mg/Nm <sup>3</sup>	NO <sub>x</sub> ppm
Gas boiler	< 10	Site and stack height specific emission in Nm <sup>3</sup> /	100 (50)	150p
	10 - 40-		100(50)	130
	40-500		50 (30)	100
	> 500		50 (30)	60
Solid fuel boiler (other than coal)	< 40		300 (200)	300p
	40-700		300 (150)	250
	> 700		300 (150)	200

**Table A2.6 Japanese waste incinerator LEVs<sup>681</sup>**

Dry gas, @ 12 % O <sub>2</sub>	Cap. ton/ h	SO <sub>x</sub> mg/Nm <sup>3</sup>	Dust mg/Nm <sup>3</sup>	NO <sub>x</sub> ppm	HCl mg/Nm <sup>3</sup>	Dioxin mg/Nm <sup>3</sup>	CO mg/Nm <sup>3</sup>	Hg mg/Nm <sup>3</sup>
Incinerator type (new facilities)								
Waste material continuous incinerator (vortex combust.)	2 - 4	Site and stack height specific emission in Nm <sup>3</sup> /h	80	450	700	1	38	Not regulated
	> 4		40			0.1		
Waste material continuous incinerator (other)	- 2		150	250		5		
	2 - 4		80			1		
	> 4 t		40			0.1		
Typical client specification <sup>682</sup>			143-157	10		<50		

<sup>680</sup> <https://www.env.go.jp/en/air/qa/air.html>

<sup>681</sup> <https://www.env.go.jp/en/air/qa/air.html>

<sup>682</sup> Waste Management and Recycling in Japan. Opportunities for European Companies (SMEs focus) Christine Yolin. EU-Japan Centre for Industrial Cooperation. Tokyo September 2015

## US EPA EMISSION LIMITS

**Table A2.7 US EPA emission limits for commercial and industrial waste incinerators**

Subpart CCCC of 40 CFR Part 60—Commercial and Industrial Solid Waste Incineration Units That Commenced Construction after June 4, 2010, or Reconstruction or Modification after August 7, 2013					
Pollutants @ 7% O <sub>2</sub> in dry gas	Incinerators (Table 5)	Energy Recovery Units (Table 6)		Waste-Burning kilns (Table 7)	Small, remote incinerators (Table 8)
		Gas/liquid	Biomass		
Cadmium, mg/Nm <sup>3</sup> dry	0,0023	0.023	0.0014	0.0014	0.67
Carbon monoxide, ppm	17	35	240	90 long	13
Dioxins, furans ng/Nm <sup>3</sup>	(tot. mass)	0.58		0.51	1 800
	(toxic eq.)	0.13	0.076	0.093	31
Fugitive ash, visible in % within hourly period	< 5	< 5			< 5
Hydrogen chloride ppm	0,091	14	0.2	3	200
Lead, mg/Nm <sup>3</sup>	0.015	0.096	0.014	0.014	2.0
Mercury, mg/Nm <sup>3</sup>	0.0084	0.00056	0.0022	0.0037	0.0035
Oxides of nitrogen ppm	23	76	290	200	170
Particulate matter (filterable) mg/Nm <sup>3</sup>	18	110	5.1	4,9	270
Sulphur dioxide, ppm vol.	11	720	7.3	28	1.2

**Table A2.8 US EPA emission limits for waste incinerators**

Pollutants @ 7% O <sub>2</sub> in dry gas	40 CFR Part 60, Subparts Cb and Eb - 71 FR 27324	Subpart AAAA of 40 CFR Part 60	
	Large MSW Incinerators > 250 s tons/day	Small MSW Incinerators 40- 250 s tons/day	Other Solid Waste Incinerator
Cadmium, mg/Nm <sup>3</sup>	0.010	0.020	0.018
Carbon monoxide, ppm	17	50-200*	40
Dioxins, furans ng/Nm <sup>3</sup>	(tot. mass)	0.13	0.33
	(toxic eq.)		
Fugitive ash, visible in % within hourly period		5	
Opacity, %		10	10
Hydrogen chloride ppm vol.	25 or 95 % reduction	25 or 95 % reduction	15
Lead, mg/Nm <sup>3</sup>	0.14	0.20	0.226
Mercury, mg/Nm <sup>3</sup>	0.05 or 85 % reduction	0.08 or 85 % reduction	0.074
Oxides of nitrogen ppm vol.	150	150, 500**	103
Particulate matter (filterable) mg/Nm <sup>3</sup>	20	24	30
Sulphur dioxide, ppm vol.	30 or 80 % reduction	30 or 80 % reduction	3.1

\* Technology dependant, mass burn 100, stoker 150, FB 150-200

\*\* Aggregated units on site, aggregated capacity above or below 250 short tons per day, respectively.



## COMPARISON OF EU, JAPANESE AND US LEV'S

Below in Table A2.9 the data on limiting emission values from Tables A2.1 to Tables A2.5 and Tables A2.7 and A2.8 are shown after recalculation to a common reference condition, namely mg/Nm<sup>3</sup> dry gas @ 11 % O<sub>2</sub> to allow a direct comparison of the limiting emission values.

**Table A2.9 Comparison of EU, Japanese and US limiting emission values**

mg/Nm <sup>3</sup> dry gas @ 11 % O <sub>2</sub>	EU Waste or Biomass firing (in brackets gas boilers, ICE, GT)			USA Waste Incineration 40 CFR Part 60			Japan	
	IED waste	Biomass (Gas) LCP >50 MW	Biomass MCP 1-50 MW	Incinerators		Bio- mass	Air Pollution Act**	Typical Client Criteria
				Large	Small			
<b>Dust</b>	10	13 (n.l.)	13-33 (n.l.)	14	17	4	44-90	11
<b>CO</b>	50	66 (55, 166)	n.l.	15	45-180*	215	42	< 42
<b>SO<sub>2</sub></b>	50	100-130 (20, n.l.)	130 (n.l.)	61 or 80 % red.	61 or 80 % red.	15	Site specific	160-175
<b>NO<sub>x</sub></b>	200	100-130 (55, 83-125)	200-333 (316- 333)	220	220	425	280-500	< 50
<b>HCl</b>	10			29 or 95 % red.	29 or 95 % red.	0.2	780	90-100

\* Technology dependent. Mass burn lowest, stoker intermediate, fluid. bed highest

\*\* The order establishing LEVs is undergoing revision and an amended order is expected shortly

## Appendix 3 Waste Gasification developers

Gasifier developers are listed in alphabetical order in Table A3.1.

**Disclaimer:** Making a compilation of waste gasification developers involves identifying which entities are active in the field at present, i.e. 2018, and also of selecting those that have been active but for various reason are no longer active or have decreased their activities in recent year but where their past activities has still made an imprint on the technology area. The list below is a compilation of waste gasification developers belonging to either of these three categories.

However, there are certainly still actively developers that were not identified, there are commercial and name changes among the entities listed and the retrospect selection of developers with more prominent activities in the past has been based on more or less subjective criteria.

So, this compilation does not have the pretence of being anywhere near complete; it reflects the status of the waste gasification technology developers active in 2018 and also some decades earlier, based on information found in the public domain, company information and also found by the author to be of interest enough to be selected.

There are certainly a number of developers out there that are not included in the compilation. Their absence is not reflecting on their development status or technical competence, it is more reflecting that these entities have not showed up in circumstances where the author has been able to find references to their activities.

Developer	Gasifier	Applications	Installations tph, tpa tonnes or tons (USA) per hour or year MW=thermal input MWe =Electric output	Web page
AlterNRG Corp. (CAN)	Plasma, shaft	CHP, syngas	Yoshii (JP) pilot plant 1 tph 1999 Utashinaai 5 tph 2002 Miharni-Mikata 1 tph 2002 Pune (IN) 3 tph Wulhan Kaidi (CHINA) 100 tpd syngas for BTL 2013 Teesside (UK) 2 * 1000 tpd idle	<a href="http://www.alternrg.com">www.alternrg.com</a>
Advanced Plasma Processes, APP. (UK)	FB (Outotec), plasma thermal unit	CHP, syngas	Pilot unit Swindon Tysely Urban Resource Centre 1 000 tpa SNG demo in constr.	<a href="http://www.advancedplasmapower.com">www.advancedplasmapower.com</a>
Aries Clean Energy (USA)	Downdraft	CHP, fuel gas	Covington, TN, USA 12 tpd 2013 CHP via ORC, 125 KWe Lebanon, TN, USA 64 tpd, CHP via ORC, 420 kWe	<a href="http://ariescleanenergy.com">ariescleanenergy.com</a>
Babcock Hitachi (JP)	see Hitachi			
Bioengineering Resources Inc.	Grate		See Ineos bio	<a href="http://www.bioenergyresourcesllc.com">www.bioenergyresourcesllc.com</a>
Biomass Energy Systems, Inc. BESTI (USA)	Rotary Kiln	CHP	S. Korea 4 tph Honolulu, Hawaii 10 tpd 2015 University Park, Ill. 2 tpd pilot 2017	<a href="http://bestiusa.com">bestiusa.com</a>
Biomass Power Ltd. (UK)	Step grate		Hoddesdon 10 MWe start-up Aberdare 11 MWe in construction Belfast 15 MWe in construction Hamilton, in planning Washwood, in planning	<a href="http://www.biomasspower.co.uk/">www.biomasspower.co.uk/</a>
Brightstar Environmental (AU)	Separation by autoclaving Ext. heated pyrolysis Stream gasification of char Solid Waste and Energy Recycling Facility (SWERF)	CHP	Kembla Grange, Wollongong, Australia 50 000 tpa 2001-2004	<a href="http://www.brightstarenvironmental.com">www.brightstarenvironmental.com</a>
Boson Energy (LU)	Updraft plasma		Link to EER plasma technology, Israel	<a href="http://www.bosonenergy.com">www.bosonenergy.com</a>
Chinook Science (USA)	Batch pyrolysis, thermal oxidation		West Midlands. 160 000tpa ASR converted to 40 MWe Eastern US 160 000 tpa ASR Also claims to have 16 plants in operation worldwide. Three projects, Westbury, Dagenham and Skelton Grange in planning in the UK.	<a href="http://www.chinooksciences.com">www.chinooksciences.com</a>
CHOPower (FR)	Gasifier, plasma posttreatment PRME gasifier	CHP	Morcens, France 40 MW Three project in planning in France, Thouars, Locomin� and Montauban de Bretagne, Brodliande, Le Pohier, Rives de Moselle KIWI pilot with Kobelco 2010-2015 0.8 tph, 4 MW	<a href="http://www.cho-power.com">www.cho-power.com</a>
	Kobelco FB gasifier			

Developer	Gasifier	Applications	Installations tph, tpa tonnes or tons (USA) per hour or year MW=thermal input MWE =Electric output	Web page
Concord Blue (DE)	Three stage moving bed		Mahad, IN 2011 1200 Nm <sup>3</sup> /hr Omuta, JP 300 Nm <sup>3</sup> /hr Mumbai, IN 2009 Izurno, JP 0.25 MWE 2006 Pune, IN 3*3MWE 2012 Herten, DE 5MWE in constr. ? Cardiff, UK, 10 MWE , in planning Chennai, IN, 15 MWE in constr. ?	<a href="http://www.concordblueenergy.com">www.concordblueenergy.com</a>
Covanta (USA)	Cleegas Grate pyrolyzer+ furnace		Tulsa, OK 12 tph pilot unit, 2012	<a href="http://www.covanta.com">www.covanta.com</a>
D4Energy (USA)	Pyrolysis, hydro-pyrolysis			<a href="http://d4energy.com">d4energy.com</a>
DPS Process Solution (UK)	Pyrolysis/gasification	Heat, CHP	Small scale plant, 1 000 to 10 000 tpa. Planning for Severn Bridge, Caldicot. Bankrupt 2018	<a href="http://www.endwasteandbioenergy.com/article/146317">www.endwasteandbioenergy.com/article/146317</a>
Ebara (JP)	CFB, Twin REC gasifier		Joetsu, Niigata 2*8 tpd 2000 Kurobe, Toyama 1* 63 tpd 2001 Sakata, Yamagata, 2*98 tpd 2002 Kawaguchi, Satama 3*140 tpd 2002 Ube, Yamaguchi 3*66 tpd 2002 Aomori, Aomori 2*225 tpd 2002 Sekii, Gifu 3*56 2003 Lida, Nagano 2*47 2003 Nagareyama, Chiba 3*69 tpd 2004 Tokyo Rinki, Tokyo 2*275 tpd 2006 Hino, Shiba 3*60 tpd 2007 Dalseung, Korea 1*70 tpd 2008 (Lic) Eunpyeong, Korea 1*48 tpd, 2009 (Lic.) Hwasung, Korea, 2*150 tpd, 2010 (Lic.) Kurahama, Okinawa, 3*103 tpd 2010 <i>Green Valley 2*100 tpd 2010 (Lic.)</i> UBE 2*307 tpd 2001, 2002 Showa Denko K.K., 195 tpd, 2003	<a href="http://www.eep.ebara.com">www.eep.ebara.com</a>
EUP (Ebara UBE Process) (JP)	Pressurized twin CFB			<a href="http://www.eep.ebara.com">www.eep.ebara.com</a>
Eneco (CA)	Unclear	CHP	Claim to have 10 units in S-E Asia, Canada	<a href="http://eneco.ca">eneco.ca</a>
Energos (UK, NO)	Grate	CHP	Ranheim (NO) 10 000 tpa 1997-2010 Averøy (NO) 34 000 tpa 2000-2011 Hurum (NO) 36 000 tpa 2001-2011 Minden (DE) 37 000 tpa 2001 Sarpsborg (NO) 2*38 000 tpa 2002 Forus (NO) 38 000 tpa 2002 Isle of Whight retrofit 30 000 tpa (UK) 2009 Sarpsborg (NO) 2*38 000 tpa 2010 Polnadle, Glasgow 144 000 tpa (UK) 2018 Sinfm, Derby (UK) 144 000 tpa 2018 Milton Keynes, 96 000 tpa (UK) 2018 <i>Bankrupt + restructuring in 2016</i> Enerkem Alberta Biofuels, AB, (CA) 100 000 tpa RDF	<a href="http://www.energ-group.com/energy-from-waste/">www.energ-group.com/energy-from-waste/</a>
Enerkem (CAN)	FB	Ethanol		<a href="http://www.enerkem.com">www.enerkem.com</a>
Entech	Grate+ combustor			<a href="http://www.entech-res.com/wtgas/">www.entech-res.com/wtgas/</a>

Developer	Gasifier	Applications	Installations tph, tpa tonnes or tons (USA) per hour or year MW = thermal input MWe = Electric output	Web page
ENVIROTHERM GmbH	Fix bed, slagging British Gas Lurgi CFB		Schwarze Pumpe (DE) 1992-2006 Rudersdorf cement 75 MW (DE) 1996- Amerigas 70 MW (NL) 2000-2014, decision on op. Pending see also Lurgi	<a href="http://www.envirotherm.de">www.envirotherm.de</a>
Environmental Energy Resources Ltd. (EER)	Fixed-bed, updraft countercurrent plasma		Yibin, (IL) 12-20 tpd 2006	
EQTEC	FB	CHP	Osnabruck 0.5 MWe in design Reliance Energy Melton Hill 16 MWe in planning Reliance Energy Seals Sands 12 MWe in planning Usk 6 MWe in planning	<a href="http://eqtec.es">eqtec.es</a> <a href="http://eqtepc.com">eqtepc.com</a>
Foster Wheeler (FI), now Sumitomo Foster Wheeler	CFB	Fuel gas, syngas	Lime kiln gasifiers (FI+SE) Kyrnjarvi 1 (FI) 70 MW Ruien (BE) 70 MW Varmamo (SE) 18 MW Valkaus (FI) 12 MW	<a href="http://www.fwc.com">www.fwc.com</a>
Frontline Bioenergy (USA)	FB	Fuel gas, syngas	Chippewa Valley Ethanol Syrtech Energy Centre, (UK), 1 MWe in construction	<a href="http://www.frontlinebioenergy.com">www.frontlinebioenergy.com</a>
Güssing Renewable Energy GmbH, GRE. (AT)	FIGFB	CHP	Nong Bua, Thailand, 4 MWth, 1 MWe, RDF op. 2017 Daigo, Jp., 4 MWth, 1 MWe. Various fuels, in commissioning	<a href="http://www.gussingrenewable.com">www.gussingrenewable.com</a>
Greene (ES)	3-stage (kiln gasifier, kiln pyrolyzer, thermal gas cleaning, licensee of or cooperation partner for PRME and Edtec.	CHP	0.5 MWe from RDF Zaragoza 2013	<a href="http://greene.es">greene.es</a>
Guascor (ES)				<a href="http://www.guascorbioenergia.com">www.guascorbioenergia.com</a>
Hitachi (JP)	Plasma shaft process		Westinghouse process license Yoshi 2000 6 ton/hr Utashina 2002-2013 6 ton/hr Mihama-Mikati 1 ton/hr 2002	<a href="http://www.alternrg.com">www.alternrg.com</a>
	Pyrolysis Klin		Eddith process, licensor Thide Itsiogawa (JP) 25000 tpa Izumo (JP) 70 000 tpa	
Hitachi Zosen	FB		9 units in Japan Toyoda Alchi 15 tph 2007 Namyangju S Korea 4 tph 2012	<a href="http://www.hitachizosen.jp">www.hitachizosen.jp</a>
HoST (NL)	CFB	CHP, SNG	Galati, (RO) 4.5 MW Biomass residues Santiago de Besteros (PT) 5 MW, chicken litter, other fuel tests	<a href="http://www.host.nl">www.host.nl</a>
ICM, Inc.	Auger gasifier	Fuel gas, CHP, char	Harvey County, KS, 200 tpd MSW 2009-2012 Colway, KS, unknown capacity for CHP	<a href="http://www.icminc.com">www.icminc.com</a>

Developer	Gasifier	Applications	Installations tph, tpa tonnes or tons (USA) per hour or year MW=thermal input MWe =Electric output	Web page
34	IHI (JP) IHI Pyrolysis Gasification & Melting System TIGAR CFB+ FB process Auger gasifier		Chita, (JP) 2*65 tpd 2003 pilot plant Indanisa Mecca, CA, USA 1.5 tph LA County	www.ihico.jp
35	International Environmental Solutions IES, USA			
36	InEntech (USA)	Plasma melt gasifier	Various	www.inentec.com
37	INEOS New Planet BioEnergy	Consumat gasifier	300 tpd feed to ethanol+ 6 Mwe 2012-2014	http://www.ineosbio.com
38	IWT	Thermoselect licensee		www.iwtonline.com
39	JFE (JP)	Shaft Furnace Gasifying and Melting System (NKK)	Kakamigahara, Gifu 3*3 tph 2003 Amagi, Fukuoka 2*2,5 tph 2003 Hidaka, Hokkaido 2*1 tph 2003 Moroka-Shiwa, Iwate 2*3 tph 2003 Saiki, Oita 2*2 tph 2003 Fukuyama, Hiroshima 13 tph 2004 Kasama, Ibaraki 2*3 tph 2006 Aki, Kochi 2*17 tph 2006 Hamada, Shimane 2*2 tph 2006 Chikushino, Fukuoka 2*5 tph 2008 Albano (IT) 2006, 2*13 tph, license to Gruppo Serrain Cecchini Nanyang Technol. University (NTU), Singapore 0.5 tph 2018	http://www.jfe-eng.co.jp/en/products/environmenter
40	JFE (JP)	Tunnel Kiln (Thermoselect)	Power Chiba 2*150 tpd 1999 Mutsu 2*70 tpd 2003 2,4 MWe Nagasaki 3*100 tpd 2005 7.5 MWe Kurashiki 2*185 tpd 2005 Yorii 2*225 tpd 2005 23 MWe, 3MWe engines Sainokuni 2006 3MWe = Yorii Tokushima 2*60 tpd 2005 1.8MWe Izumi 1*95 tpd 2005 Okayama, Japan 20 tph 2005 = Kurashiki OK Isehaya 2005 7.5 MWe =nagasaki Yoshino 2005 1.8 MWe= tokushima	
41	JFE (JP)	Updraft (Bacoock-Völund)	CHP Yamagata 8 MW 2007 Ishigawa 9 MW Daijo 12 MW 2009	
42	Kawazaki Giken (JP)	Shaft	Hokushou Hokuibu 3 tph Chubu-hta 6 tph Hamamatsu 2 tph Nikko 6 tph Narita 8 tph + 3 other units	www.kawasaki-giken.com

Developer	Gasifier	Applications	Installations tph, tpa tonnes or tons (USA) per hour or year MW=thermal input MWe =Electric output	Web page
Kawasaki Heavy Industries (JP)	FB	Power, CHP, fuel gas	Tokyo Setagaya 300 tpd Shaft gasifier Site n.a., Japan 1*43 tpd CHP Fluidized bed gasifier Site n.a., Shiga 2*37,5 tpd CHP Setagaya, Clean Association of Tokyo 23, Tokyo 2*150 tpd 2010 CHP Fluidized bed gasifier , cement kiln Tongling Conch Cement, Tongling City, Anhui, 300 tpd*1, 2010 Guiding, Guizhou, 200 tpd*1, 2012 Zunyi, Guizhou, 400 tpd*1, 2013 Pingliang Conch Cement, Pingliang City, Gansu, 300 tpd*1 Chongqing Conch Cement, Chongqing City, 200 tpd*1, Fujian Longlin Group, Longyan City, Fujian, 400 tpd*1 Zunyi Conch Panjiang Cement, Zunyi City, Guizhou, 400 tpd*2 Qingzhen Conch Cement, Qingzhen City, Guizhou, 300 tpd*1, Yangchun Conch Cement, Yangchun City, Guangdong, 200 tpd*1, Qiyang Conch Cement, Qiyang County, Hunan, 300 tpd*1, Shuangfeng Conch Cement, Shuangfeng County, Hunan, 200 tpd*1, Shimen Conch Cement, Shimen County, Hunan, 200 tpd*1, Nanjiang Conch Cement, Nanjiang County, Sichuan, 200 tpd*1, Yuping Ketelin Cement, Yuping County, Guizhou, 100 tpd*1, TCC Anshun Cement, Anshun City, Guizhou, 200 tpd*1, Sctus Xishui Cement, Xishui County, Guizhou, 300 tpd*1, Shuicheng Conch Cement, Shuicheng County, Guizhou, 200 tpd*1 Esheng Cement, Emeshaan City, Sichuan, 400 tpd*1, Baoshan Conch Cement, Baoshan City, Yunnan, 300 tpd*1, Fusu Xinning Conch Cement, Fusu County, Guangxi, 200 tpd*1, Guangxi Lingyun Tonghong Cement, Lingyun County, Guangxi Zhuang, 100 tpd*1 Tongling Conch Cement, Tongling City, Anhui, 300 tpd*1,	www.khi.co.jp/english/aplant/index.html
Kobelco (JP)	FB	Fuel gas, CHP	Chubur-Kamikita, Amori 2* 1,5 tph 2000 Aki, Hiroshima 2*3 tph 2002 Kasuno, Aki 2*1,5 tph 2002 Ishinomaki, Miagi 2*5 tph 2003 Nakatsugawa, Gifu 2*2 tph 2004 Ono-Katsuyama, Fukui 2*2 tph 2006 Nemuro-Hokubu, Hokkaido 2*1,5tph 2007 Sashima, Ibaraki 2*4 tph 2008 Iwade, Wakayama 2*1,5 tph 2008 Kawagoe, Saitama 2*6 tph 2010 Sagamihara, Kanagawa 2*7 tph 2010 Pangyo Clean Tower, S. Korea (licensing) 2* 2tph 2009 Paju Engyon New Town, S. Korea (licensing) 2* 2 tph 2011 Haga, Tochigi 2*3 tph 2014 Nishikigawa, Tokyo 2*2,5 tph 2014 Senman, Miyagi 2*4 tph 2017 Kofu-Kyoto, Yamanshi 3*5 tph 2017 Koiki, Yamagat 2*3 tph 2018 Kamitina Koiki 2*2,5tph 2019 Walsall, UK, 20 MWe in planning	www.kobelco-eco.co.jp
45	Leroux Lotz Technologies (LLT)	CFB (Successor to TPS)	ESKA, Hoogzaand (NL) 15 MW 2016 Villiers-sous-Montrond (FR), 50 GWh/e/90 GWhth 2018	www.lerouxlotz.com

Developer	Casifier	Applications	Installations tph, tpa tonnes or tons (USA) per hour or year MW=thermal input MWe =Electric output	Web page
Lurgi	EF		Schwarze Pumpe complex 1992 Bergakademie Freiberg pilot (DE) Bioliq pilot 5 MW 2011 (DE)	
Lurgi	CFB		Schwarze Pumpe complex 1992 Rudersdorf Cement 7.5 MW 1996 Ameygas 70 MW 2000-2014, decision pending	see Envirotherm
Michaelis (DE)	Grate type		Glasgow (UK), 2 <sup>1</sup> 30 000 tpa	<a href="http://www.michaelis-umwelttechnik.de">michaelis-umwelttechnik.de</a>
Mitsubishi Heavy Industries (JP)	FB	Power	Kushiro 2 <sup>1</sup> 120 tpd 4,6 MWe 2006 Yamagata 2 <sup>1</sup> 75 tpd 2017	<a href="http://www.mhiac.co.jp/en/products/recycle/ctf/">http://www.mhiac.co.jp/en/products/recycle/ctf/</a>
Mitsui (JP)	Pyrolysis kiln, licensee to Siemens, Thide Environnement	Power	Chiba 1 tph 1994-2000 Yokohama 1 tph 1994-2000 Yame Saiby 2 <sup>1</sup> 5 tph 2000 Toyohashi, Japan 15 tph 2002 Ebetsu 2 <sup>1</sup> 3 tph 2002 Koga city 2 <sup>1</sup> 3 tph 2003 Nishi Iburi 2 <sup>1</sup> 2 tph 2003 Kyouku 2 <sup>1</sup> 2 tph 2003 Hamamatsu 3 <sup>1</sup> 150 2009 Yangju City, S. Korea 2 <sup>1</sup> 100 2009	<a href="http://www.mes.co.jp">www.mes.co.jp</a>
Nexterra (CAN)	Fixed bed		Dartmoor, Plymouth (UK) 3,5 MWe, in constr. Welland (UK), 67 000 tpa, 9 MWe, 2017 Tyseley, Birmingham (UK) , 9 MWe, 2017	<a href="http://www.nexterra.ca">www.nexterra.ca</a>
51				



Developer	Gasifier	Applications	Installations tpd, tpa tonnes or tons (USA) per hour or year MW=thermal input MW =Electric output	Web page
Nippon steel (JP)	Shaft furnace	Power	<p>Kamaishi City 2*55 tpd 1979-2011 Hot water Ibaraki, Japan 3*150 tpd 1988, 2*150 tpd 1996-2011 10 MW Iryu 2*60 tpd 1.1 MW 1997 East Inclination Facilities Union 2*65 tpd 1997, 1.6 MW, +65 tpd 2002, 1.1 MW Izuka City 2*90 tpd 1998 1.2 MW Itoshima City 2*100 tpd, 3 MW 2000 Kameyama City 2*40 tpd, 1.2 MW 2000 Akita 2*100 tpd 2002, increased to 2*130 tpd 2012, 8.5 MW Niigata City 2*120 tpd, 1.5 MW 2002 Kazusa Clean System Co.2*100 tpd 3MW 2002 Shizukushi 2*50 tpd, 1.2 MW 2002 Hata 2*70 tpd, 1.8 MW 2002 Narashino City, 3*73 tpd 2.4 MW 2002 Tajimi 2*85 tpd, 2 MW 2003 Toyokawa 2*65 tpd 1, 9MW 2003 Oita 3*129 tpd 9,5 MW 2003 Munakata 2*80 tpd 2.4 MW 2003 Seinoh Environmental Maintenance Union 1*90 tpd, hot water, 2004 Kita-kyushu Eco Energy Co., Ltd. 2*160 tpd, 14 MW 2005 Nippon Steel &amp; Sumitomo Nagoya Works, 2*120 tpd, steam, 2006 Shimada City 2*74 tpd, 2 MW 2006 Shin-Moji 3*240 tpd, 23,5 MW 2007 Fukuoka, Japan 30 tpd 2007 Fukuroi 2*66 tpd, 1.7 MW 2008 Yongsan S Korea 2*100, hot water,2008 Narumi Clean System Co., Ltd. Aichi 2*265 tpd, 9MW 2009 Shizuoka, Japan 20 tpd 2010 Nishigaya Plant2*250, 14 MW 2010 Himeji City, 3*134 tpd 10MW 2010 Goyang S Korea 2*150 tpd, 5.3 MW, 2010 5.3 MW Matsue City 3*85 tpd 4,8 MW 2011 4,8 MW Iwate 2*73,5 tpd 2,5 MW 2011 Okazaki 2*190 tpd 10,5 MW 2011 Sakai Clean System Co., 2*225 tpd, 13, 5 MW 2013 Tobashisei Union2*47,5 tpd, 1,2 MW 2014 Saitama 2*190 tpd, 8,5 MW 2015 Komaki 2*98,5 tpd, 4,3 MW 2015 4,3 MW Eco Association of the West Saga 2*102,5 tpd, 4,4 MW 2015 Yokkaichi 3*112 tpd, 9 MW 2016 Tobuchita 2*100 tpd, 4,5 MW 2019</p>	www.eng.nssc.com
53 Organic Energy Inc. (CA)	Fixed bed , downdraft		<p>Nord-Trøndelag Energiwerk (NO), 20 tpd MSW, steam 2001 City of Boseong, S. Korea, 2*20 tpd MSW, steam 2001, 2006 City of Gang Jin, S. Korea, 25 tpd MSW 2006</p>	organicenergy.ca
52				

Developer	Gasifier	Applications	Installations tph, tpa tonnes or tons (USA) per hour or year MW=thermal input MWe =Electric output	Web page
Outotec Energy Products (USA)	FB		Plainfield, CT, USA, 37 MWe Some additional gasifiers in the USA, some of which use waste Hooton Park, UK 240 000 tpa 27 MWe in planning, due 2020 Hull, UK, 240 000 tpa 25 MWe, in constr., due 2018 Levensat, Forth, UK, 105 000 tpa 11 MWe, 2017 Ince, UK, 22 MWe, due 2020, in constr., due 2017 Three waste wood plants (Barry, Boston and Hull Biomass UK 1, 2 & 3) in constr. UK Steam Oxygen gasifier 4.4 MWth in construction	<a href="http://www.outotec.com">www.outotec.com</a> <a href="http://www.energyproducts.com">www.energyproducts.com</a>
54				
55	PKA Umwelttechnik GmbH & Co. KG (DE)	Kiln pyrolysis		
56	Plasco (CA)	Grate	Castelgalli, Spain pilot plant Trails Road, Ottawa, Canada 4 tph demo 2007 Ottawa 15 tph plant in planning	<a href="http://www.plascoenergygroup.com">www.plascoenergygroup.com</a>
57	Plagatz AB (SE)	plasma		<a href="http://www.plagatz.se">www.plagatz.se</a>
58	Plasma Power LLC (USA)	plasma	Marion, Iowa, (USA) 250 tpd, in planning?	<a href="http://www.plasmapowerllc.com">www.plasmapowerllc.com</a>
59	Powerhouse Energy Group Plc.	Indirectly heated rotating kiln. Fka Pyromex, acquired 2013	Bisbane 1-3 tph waste plastics and tyres 2015 relocated to Thornon Science Park, Univ. Of Chester (UK) 25 tpd prototype 2017 Protos, Ince Park, Elismere port (UK) in planning for Peel Environmental	<a href="http://www.powerhouseenergy.net">www.powerhouseenergy.net</a>
60	PRIME	Updraft/crossdraft	5-6 plants in USA 25 others claimed to be available worldwide incl. Rossano de Calabria Italy, Moissanne, France	<a href="http://www.primenergy.com">www.primenergy.com</a>
61	Pyrogenesis	plasma EAF primary process, secondary plasma thermal treatment	11 tpd 0.4 MWe pilot Hulburt, FL (USA) 2010	<a href="http://www.pyrogenesis.com">www.pyrogenesis.com</a>
62	Pyrox GmbH	Fixed bed		<a href="http://www.woodgas.eu">www.woodgas.eu</a>
63	Recycling Solutions Technology	Kiln	Inez, KY 12 tph	

	Developer	Gasifier	Applications	Installations tpm, tpa tonnes or tons (USA) per hour or year MW=thermal input MWe =Electric output	Web page
64	Synova	Milena Dual bed	CHP, syngas	Ambigo fka HVC 12 MW (NL) Thailand 2 WGE projects in with gas turbines	synovapower.com
65	Scanarc ab	Shaft plasma		pilot plant Hofors Sweden	www.scanarc.se
66	Sierra Energy	Shaft	CHP, syngas	Fort Hunter Liggett, CA, (USA) 20 tpd 1 MWe 2017	www.sierraenergy.com
67	Siemens KWU	Kiln		Ulm-Wiblingen 4 tpd 1988-96 Furth 2*50 000 tpa 1997-1999 Licensed to Mitsui and Takuma	
68	Solena	Plasma		Greensky London and other projects. Bankrupt 2015	sgbiopower.com
69	Splainex (NL)	Pyrolysis kiln		35 000 tpa plant MSW, IW plants. No details found	www.splainex.com
70	Sumitomo (JP)	FB (UHDHTW license)		Niihama 2 tpm pilot	www.shi.co.jp
71	Syngas Products (UK) fka NEAT	Pyrolysis/gasification	Power (CHP)	Avonmouth 100 000 tpa 2013 Canford 100 000 tpa in planning	www.syngas-products.com
72	Takuma (JP)	Pyrolysis kiln Siemens KWU license	Power	Six units 2-4 tpm per line Kobuko, Kagishima 2*81 tpd 2003 Kamiso, Hokkaido 2*64 tpd 2003 Kakegawa, Shizuoka 2*70 2005 Joso, Hibaraki 3* 86 tpd 2012	www.takuma.co.jp
73	Taylor Biomass Energy (USA)	Dual Bed	Power	Montgomery, NY, USA, 21 MWe in planning	www.taylorbiomassenergy.com
74	Thermoselect (IT, LH)	Tunnel Kiln	Fuel gas, power	Fondotoce 1*100 tpm 1992-1999 Karlsruhe 3*10 tpm 2000-2003 Ansbach 10 tpm, never operated	www.vivacorp.com
75	Thide Environmental (FR)	Indirect heated kiln Eddith process		Arras 50 000 tpa 2003 Licensee Hitachi Italogawa (JP) 25000 tpa Izumoto (JP) 70 000 tpa	
76	Toshiba (JP)			Licensee to PKA Umweltechnik GmbH & Co. KG	
77	TPS Termiska Processer AB (SE)	CFB	Power, fuel gas	Greve-in-Chianti (IT) 2*15 MWh, 3.7 MWe 1996-2004	See LIT www.lenuxlotz.com

	Developer	Gasifier	Applications	Installations tpd, tpa tonnes or tons (USA) per hour or year MW=thermal input MWe =Electric output	Web page
78	Thermochem Recovery Inc. TRI (USA)	FB	Power, FT syngas	Durham NC, PDU Norampac, Canada 10 MW Black liquor 2003 Project Independence 100 MW biomass feed FT, terminated Project Trixie Synthesis 100 MW biomass feed FT, terminated Fulcrum Sierra Bioenergy 200 000 tpa RDF in construc.	www.tri-inc.net
79	UHDE (DE)	HTW FB	Syngas License to Sumitomo	Kemira Ojlo peat 100 MW 1989 Värmlandsmetanol, in planning Sundrop Biofuels, in planning	www.uhde.eu
80	Valmet Power (FI)	CFB	CHP, syngas	Vaskiluoto (FI) 140MW 2014 Kymjärvi II (FI) 2-80MW 2012 (GobGas (SE) licensee to Repotec) 2013	www.valmet.com
81	Vicat & Berkes	Fixed bed?	Cement	Cimentiere Vicat, Crechty, (FR)	http://www.berkes.com/uy/en/news/122-energy/
82	Waste Gen (UK), Tech Trade (DE), Technip (FR)	Indirect and direct pyrolysis kilns aka Contherm	Power, char for co-firing	Burgau 2*3 ton/h CHP 1984-2015 Ham 2* 12 ton/h (75 MW total, 10% NG), co-firing 2001-2009	techtrade.de/backup/company.html
83	WTEC (Waste technology of Canada)	Batch gasification close coupled combustion	CHP	Dargavel, UK , not in. Op. Old Crow, Yukon, Canada, 2012 Peccolli, Italy 5 tpd lixked Waste Kwajalein Atoll, US Army, Marshal Islands, 38 tpd MSW, in construction Husavik, Iceland 2*10 tpd MSW 2006 Fc. Greedy, Alaska, 4 tpd MSW Lincoln County, Wyoming, 2 tpd, MSW Thorax, Coffs Harbor, Victoria Australia, 200 tpd, IW Egecik, Alaska, 3.5 tpd MSW, 2000 Richway Environmental Preservation Co., Ltd Beijing China, 10 tpd IW Erenwaste Taiwan, Cheng Wen Lin, 12 tpd IW MagLite, Croatia, 3 tpd MSW Goodwood Managm. Corp, Cavite Philippines, 50 tpd MSW Dagupan Philippines, Goodwood Inc, 35 tpd MSW Procter & Gamble, Jakarta Indonesia, 6 tpd IW Dunthies (UK) 60 000tpa, 6 MWe 2009-2013 (loss of permit)	wtecandata.com
84	WZE	See BEST		See BEST	wzes.com

## Appendix 4 Waste Gasification Plants and Projects

Gasifier plants and projects are listed in alphabetical order based on their identified name or location in Table A4.1.

**Disclaimer:** Making a compilation of waste gasification plants and projects involves identifying which plants and planned projects that are active in the field at present, i.e. 2018, and also of selecting those plants and projects that have been operated or actively pursued but for various reason are no longer active or have decreased their activities in recent year but where their past activities has still made an imprint on the technology area. The list below is a compilation of waste gasification plants and project developments belonging to either of these three categories.

However, there are certainly still active developments in the field of waste gasification, or project developments no longer pursued that were not identified, and there are commercial and name changes among the entities listed that may result in the continuity of the developments have been lost. Furthermore, the retrospect selection of plants project developments with more prominent activities in the past has been based on more or less subjective criteria.

So, this compilation does not have the pretence of being anywhere near complete; it reflects the status of the waste gasification technology plants and developments active in 2018 and also some decades earlier based on information found in the public domain, company information and also found by the author to be of interest enough to be selected.

There are certainly a number of developments out there that are not included in this compilation as references were not found or because a selection based on interest at present was made.

Project name	Developer	Location	Gasifier	Capacity	Fuels	Applications	Status	Web page
1 Aberdeen	Enviro Parks Ltd	Hirnam (UK)	Biomass Power Ltd.	240 000 tpa	RDF, CWM	11 MWe	In construction, CfD contract	<a href="http://www.enviroparks.co.uk/en/">www.enviroparks.co.uk/en/</a>
2 Aki	Aki Association	Aki, Hiroshima (JP)	Kobelco	2*3 tph	MSW	Power/heat	2002	<a href="http://www.kobelco-eo.co.jp">www.kobelco-eo.co.jp</a>
3 Aki	Aki Association	Aki, Kochi (JP)	JFE (Shaft furnace)	2*17 tph	Waste	Power/heat	2006	<a href="http://www.jfe-eng.co.jp/en/products/environment/">http://www.jfe-eng.co.jp/en/products/environment/</a>
4 Akiya	Akiya City	Akiya City, Akiya Pref. (JP)	Nippon Steel & Sumikin Engineering	2*230 tpd	MSW, Incombustible Residues Sludge, Incineration Residues	8.5 MWe	2002 expanded 2012	<a href="http://www.eng.nsscnc.com">www.eng.nsscnc.com</a>
5 Albano (APP Albano Power Plant)	COEMA, SPV within SCA Group (IT)	Albano (IT)	JFE (Shaft furnace)	2*308 tpd (3 lines planned)	Waste	33 MWe (50 MWe 3 lines)	2016	<a href="http://www.jfe-eng.co.jp/en/foreign/int07.html">http://www.jfe-eng.co.jp/en/foreign/int07.html</a>
6 Amagi	Amagi Asakura Mill Association	Amagi, Fukuoka (JP)	JFE (Shaft furnace)	2*3 tph 2003	Waste	Power/heat		<a href="http://www.jfe-eng.co.jp/en/products/environment/">http://www.jfe-eng.co.jp/en/products/environment/</a>
7 Ambigo	Ambigo	Akmaar (NL)	Symova (Mena gasifier)		Biomass, RDF	4 MW SNG	In planning	<a href="http://www.ambigo.nl">www.ambigo.nl</a>
8 Amergas	RWE Generation	Geturlenberg (NL)	Lurgi Mjjstechnik	70 MW	Demolition wood	Indirect co-firing	In operation	<a href="http://www.rwe.com/web/cms/nl/171654/rwe-generation-se/brandstoffer/overzicht-locaties/nederland/amercentral/">http://www.rwe.com/web/cms/nl/171654/rwe-generation-se/brandstoffer/overzicht-locaties/nederland/amercentral/</a>
9 Ansbach		Ansbach (DE)	Thermoselect	75 000 tpa	MSW	Power	Constructed in 2000 but not operated	<a href="http://www.vivetracorp.com">www.vivetracorp.com</a>
10 Ansbach		Ansbach (DE)	Thermoselect	80 tpd			2000, never operated	<a href="http://www.vivetracorp.com">www.vivetracorp.com</a>
11 Anshun	TCC Anshun Cement	Anshun, Guizhou (CN)	Kawazaki Heavy Industries	200 tpd*1	MSW	Cement	2016	<a href="http://www.khi.co.jp/english/kplant/index.html">www.khi.co.jp/english/kplant/index.html</a>
12 Aomori	RER Aomori Renewable Energy/Recycling Co.,Ltd.	Aomori, Aomori (JP)	Ebara	2*225 tpd	ASR, sludge	18 MWe	2002	<a href="http://www.eep.ebara.com">www.eep.ebara.com</a>
13 Ardre	DREN Ltd	Eggborough (UK)	Not available (Biomass Power?)	200 000 tpa	Waste wood, RDF	10 MWe	In planning	<a href="http://www.drenl.co.uk">www.drenl.co.uk</a>
14 Athlseye	Thide Environment	Aras (FR)	Eddih	50 000 tpa	MSW	Heat+ coke	2003	
15 Averdy		Averdy (NO)	Energos		Wastes	CHP	2000-2011	<a href="http://www.energ-group.com/energy-from-waste/">www.energ-group.com/energy-from-waste/</a>
16 Avonmouth	Syngas Products	Avonmouth (UK)	Syngas products f/a NEAT	100 000 tpd	RDF	8 MWe	2013-2016?	<a href="http://www.syngas-products.com">www.syngas-products.com</a>
17 Baoshan	Baoshan Conchi Cement	Baoshan, Yunnan (CN)	Kawazaki Heavy Industries	300 tpd*1	MSW	Cement	2016	<a href="http://www.khi.co.jp/english/kplant/index.html">www.khi.co.jp/english/kplant/index.html</a>
18 Barry	Biomass UK No. 2	Barry, Wales (UK)		94 000 tpa	Waste wood, RDF	10 MWe	In planning, permit 2018	<a href="https://www.energ-wasteandbioenergy.com/article/1456666/uk-barry-classification-plant-clears-final-hurdle">https://www.energ-wasteandbioenergy.com/article/1456666/uk-barry-classification-plant-clears-final-hurdle</a>
19 Barry Docks	Biogen Power (Energos)	Barry, Wales (UK)	Energos	80 000 tpa	Wastes	Power	In planning (Energos bankrupt 2016). Status not clear	<a href="http://www.witecarada.com">witecarada.com</a>
20 Beijing	Richway Environmental	Beijing (CN)	WTEC	10 tpd	IW			
21 Belfast	Full Circle Generation, RiverRidge Energy Limited,	Belfast, UK	Biomass Power Ltd.	3 units, 60 MW total	RDF	15 MWe	Due for start-up 2018	<a href="http://www.biomasspower.co.uk">http://www.biomasspower.co.uk</a>

Project name	Developer	Location	Gasifier	Capacity	Fuels	Applications	Status	Web page
22 Benson	Chippewa Valley Ethanol	Benson MN	Frontline Bioenergy		biomass residues	CHP	In operation	<a href="http://cvec.com">cvec.com</a> , <a href="http://www.frontlinebioenergy.com">www.frontlinebioenergy.com</a>
23 Blisshope	Waste2Tricity	Blisshope UK	AltanRG		Wastes	16.6 MWe	Status unknown after Tees project failure	<a href="http://www.waste2tricity.com/blisshope.html">www.waste2tricity.com/blisshope.html</a>
24 Blisshope Colliery	Peel Environmental			120 000 tpa	8MWe		In planning	<a href="http://www.peelenvironmental.co.uk/current-opportunities-blog/blisshope-colliery">www.peelenvironmental.co.uk/current-opportunities-blog/blisshope-colliery</a>
25 Binn Farm	Binn Waste Management Ltd.	Glenfara Scotland	Not available	60 000 tpa		4.5 MWe	In planning, permit received	<a href="http://binngroup.co.uk">binngroup.co.uk</a>
26 Blackbridge	Egnedol	Blackbridge, Milton Havens (UK)	n.a.		contaminated wood	49.9 Mwe to be expanded	Planning permission rejected June 2018	<a href="http://www.egnedol.wales">www.egnedol.wales</a> <a href="http://www.bbc.com/news/uk-wales-south-west-wales-44633694">www.bbc.com/news/uk-wales-south-west-wales-44633694</a>
27 Blackbridge TGS 1	Think Greenenergy TOPCO Ltd	Blackbridge Farm, Burton Latimer (UK)	Pyrolysis technology, n.a.	38 750 tpa	Wastes	5.56 Mwe	In Planning CFD contract 2017. Developer in voluntary liquidation 2018 Status unknown after NEAT takeover by Syngas Products	<a href="https://beta.companieshouse.gov.uk/company/09196100/filing-history">https://beta.companieshouse.gov.uk/company/09196100/filing-history</a> <a href="http://www.syngas-products.com">www.syngas-products.com</a>
28 Blaise Farm	NEAT		NEAT			CHP	In planning	<a href="http://www.concordblueenergy.com">www.concordblueenergy.com</a>
29 Blue Tower Technology Hertan	H2Herten GmbH	Herten (DE)	Concordia Blue	13 MW demo	Woody biomass		In planning	
30 Bosingong		Bosingong City, S. Korea	Organic Energy	2-20 tph	MSW	Heat	2001-, 2006	<a href="http://organicenergy.ca">organicenergy.ca</a>
31 Boston Alternative Energy Facility	Alternative Use Boston Projects Ltd	Boston (UK)	Outotec?	3 lines	RDF	50 MWe	Development Consent Order Application 2018	<a href="https://www.emswwasteandbioenergy.com/article/7498409/plants-uks-largest-efw-plant-unveiled">https://www.emswwasteandbioenergy.com/article/7498409/plants-uks-largest-efw-plant-unveiled</a>
32 Bradford	BH Energy Gap	Ripley Road, Bradford (UK)	Not available (Kobelco?)	160 000 tpa	Wastes	20 MWe	In planning	<a href="http://www.bhenergygap.co.uk/projects-bradford/#_overview">http://www.bhenergygap.co.uk/projects-bradford/#_overview</a>
33 Brent Cross	Clean Power Properties Ltd	Cricklewood, Barnet (UK)	pyrolysis technology, n.a.	128 000 tpa		15 MWe	In planning, permission 2014.	<a href="http://www.cleanpowerproperties.com">www.cleanpowerproperties.com</a>
34 Bridgewater	Bridgewater Resource Recovery	Bridgewater, North Petherton (UK)	Originally Energex, but not known at present	90 000 tpa	RDF	c. 9 MWe	In planning 2016.	<a href="http://www.b-rrf.com">www.b-rrf.com</a>
35 Bristol (Avonmouth and Severn recovery parks)	Suez Environmental	Bristol UK	Kobelco?		RDF		Planned as a gasifier, but built as an incinerator by HZ1 2016	
36 Broccilande	CHO Power	Broccilande (FR)	CHO Power	45 000 tpa	Sorted MSW	6 MWe	In planning	<a href="http://www.chobroccilande.fr/">www.chobroccilande.fr/</a>
37 Canford	Syngas Products	Canford (UK)	Syngas products, <i>Rea</i> NEAT	10 000 tpd 100 000 tpd	RDF	0.8 MWe 8 MWe	pilot unit, 2016 In planning	<a href="http://www.syngas-products.com">www.syngas-products.com</a>
38 Cardiff	Cogen/Lockheed Martin	Cardiff (UK)	Concordia Blue	150 000tpa		15 MWe	In planning, due 2020	<a href="http://www.cogenuk.com/features/lockheed-martin-cogen-build-energy-waste-plant-wales">www.cogenuk.com/features/lockheed-martin-cogen-build-energy-waste-plant-wales</a>

Project name	Developer	Location	Gasifier	Capacity	Fuels	Applications	Status	Web page
39) Cavite	Goodwood Managem. Corp	Cavite Philippines	WTEC	50 tpd	MSW			<a href="http://wecanada.com">wecanada.com</a>
40) Charlton lane	Suez Environmental	Shepperton, Hill, (UK)	Outotec Energy	45 000 tpa	RDF	3.5 MWe	Start-up in 2018	<a href="http://www.ecoparksurvey.uk">www.ecoparksurvey.uk</a>
41) Cheng Wen Lin	Enenwaste Taiwan	Cheng Wen Lin, Taiwan	WTEC	12 tpd	IW			<a href="http://wecanada.com">wecanada.com</a>
41) Chiba	Mitsui	Chiba (JP)	Mitsui	1 tpd	waste	demo	1994-200	<a href="http://www.mes.co.jp">www.mes.co.jp</a>
42) Chiba	Japan Recycle Center	Chiba (JP)	JFE (Thermoselect)	13 tpd				1999! <a href="http://www.jfe-eng.co.jp/en/products/environment/">http://www.jfe-eng.co.jp/en/products/environment/</a>
43) Chickenhall lane	Clean Power Properties	Eastleigh, (UK)	Pyrolysis technology, n.a.	195 000 tpa		8-12 MWe	In planning, planning permission 2014	<a href="http://www.cleanpowerproperties.com">www.cleanpowerproperties.com</a>
44) Chikushino	Chikushino Oguri Kyama Ass.	Chikushino, Fukoka (JP)	JFE (Shaft furnace)	2*5 tpd	Wastes	Power/heat		2008! <a href="http://www.jfe-eng.co.jp/en/products/environment/">http://www.jfe-eng.co.jp/en/products/environment/</a>
45) Chita	Chita City	Chita City	IHI kiln system	2*65 tpd	Wastes	Power/heat		2003 <a href="http://www.ihi.co.jp">www.ihi.co.jp</a>
46) Chongqing	Chongqing Conch Cement	Chongqing City (CN)	Kawasaki Heavy Industries	200 tpd*1	Wastes	Cement	Order 2014	<a href="http://www.khi.co.jp/english/kplant/index.html">www.khi.co.jp/english/kplant/index.html</a>
47) Chubu-Kanikita		Chubu-Kanikita, Aomori (JP)	Kobelco	2* 1.5 tpd	Wastes			2000 <a href="http://www.kobelco-eo.co.jp">www.kobelco-eo.co.jp</a>
48) Coathridge	Shore Energy	Coathridge (UK)	Chinook	160 000 tpa	RDF	20 MWe	Start-up 2018	<a href="http://www.shore-energy.co.uk/">www.shore-energy.co.uk/</a>
49) Colway		Colway, KS (USA)	ICM	Not available			Expansion to 27 MWe rejected 2018	<a href="http://www.enbwasteandbioenergy.com/article/1463056/plants-expanding-drv-drafts-shutled">http://www.enbwasteandbioenergy.com/article/1463056/plants-expanding-drv-drafts-shutled</a>
50) Conby	Clean Power Properties	Norwich (UK)	Biomass Power?	200 000 tpa		16 MWe	Not available	<a href="http://www.icmnc.com">www.icmnc.com</a>
51) Corenso	Stora Enso	Varkaus (FI)	Ameac Foster Wheeler	7 tpd	Paper rejects	Fuel gas 50 MWth	In planning, planning permission 2016	<a href="http://www.sh-fw.com">www.sh-fw.com</a>
52) Covington	City of Covington, TN	Covington, TN (USA)	Aires Clean Energy fka PHS Energy	4 000 tpa	waste wood, sewage sludge	0.4 MWe	2000-	2015 <a href="http://airescleanenergy.com">airescleanenergy.com</a>
53) Crechry	Vicat	Cimentiere Vicat, Crechry	Vicat & Berles	3 tpd	Wood waste, RDF	Cement	In op. 2017	<a href="http://www.berles.com/uy/en/news/122-energy/4120-gas%3B3aenq-de-iff-enfranca-2.html">http://www.berles.com/uy/en/news/122-energy/4120-gas%3B3aenq-de-iff-enfranca-2.html</a>
54) Dagenham	Thames Gateway Waste to Energy Ltd	Dagenham, London, (UK)	Chinook	190 000 tpa	RDF	20 Mwe (net 15)	In planning	<a href="http://infratamgroup.com/info/enea-uk-waste-plants-return-market-despite-challenges">infratamgroup.com/info/enea-uk-waste-plants-return-market-despite-challenges</a>
55) Daqunan	Goodwood Inc.	Daqunan Philippines	WTEC	35 tpd	MSW			<a href="http://wecanada.com">wecanada.com</a>
56) Daigo		Daigo, (JP)	GRE		Biomass+ RDF	4 MWth, 1 MWe	In commissioning	<a href="http://www.gussingrenewable.com">www.gussingrenewable.com</a>
57) Dalsung		Dalsung, Korea	Ebara (license)	1*70 tpd	MSW			2008 <a href="http://www.eep.ebara.com">www.eep.ebara.com</a>
58) Darqavel	Scotgen, sold to Rank Recycling Scotland, RRS	Dumfries, Scotland (UK)	Waste2Energy, now WTEC	60 000tpa	MSW	6 MWe	2009, ceased op. 2013, after several op. Issues. Restart under new owner?	<a href="http://https://www.lestrecycle.com/news/latest-news/firm-plans-to-reopen-20m-scotgen-incinerator/">https://www.lestrecycle.com/news/latest-news/firm-plans-to-reopen-20m-scotgen-incinerator/</a>
59) Darlington	Clean Power Properties Ltd.	Durham	Pyrolysis technology, n.a.	100 000 tpa			No information on present status	<a href="http://www.cleanpowerproperties.com">www.cleanpowerproperties.com</a>



Project name	Developer	Location	Gasifier	Capacity	Fuels	Applications	Status	Web page
60 Dartmoor Bio	Cogen	Plymouth, (UK)	Nektara		Waste timber	3.5 MWe	In constr.	<a href="http://www.cogenuk.com">www.cogenuk.com</a>
61 Doncaster	BH Energy Gap	Doncaster (UK)	Kobalco?	120 000 tpa	Wastes	12.5 Mwe	Planning permission granted, in	<a href="http://www.bhenergygap.co.uk">www.bhenergygap.co.uk</a>
62 Drakelow Renewable	Future Earth Energy	Drakelow, Burton-on-Trent (UK)	Biomass Power Ltd.	169 000 tpa	Waste paper, plastics and biomass	15 MWe/9 MWth	In planning. CfD contract 2017	<a href="http://futureearthenergy.com/drakelow/">futureearthenergy.com/drakelow/</a> <a href="http://www.enswasteanthenergy.com/article/1489390/169000-yr-">www.enswasteanthenergy.com/article/1489390/169000-yr-</a>
63 Ebatsu		Ebatsu (JP)	Mitsui	2*3 tph	MSW		2002	<a href="http://www.mes.co.jp">www.mes.co.jp</a>
64 Egecik		Egecik, Alaska (USA)	WTEC	3.5 tpd	MSW		2000	<a href="http://wtecanada.com">wtecanada.com</a>
65 Eslef	Bioessences Ltd.	Marsh Lane, Rainham Essex, UK	Valmet		MSW	25 MWe	Bio-essence in liquidation	
66 Eneishan	Esheng Cement	Eneishan City, Sichuan (CN)	Kawazaki Heavy Industries	400 tpd*1	Wastes	Cement kiln	2016	<a href="http://www.khi.co.jp/english/kibar/index.html">www.khi.co.jp/english/kibar/index.html</a>
67 Enerkem Alberta Biofuels	Enerkem Alberta Biofuels, AB, (CA)	Edmonton, Alberta (CAN)	Enerkem	100 000 tpa input	Biomass, MSW	Ethanol	in commissioning	<a href="http://www.edmontonbiofuels.ca">www.edmontonbiofuels.ca</a>
68 Enviroparc	SBS Waste partnership, Brickkiln	Derry (UK)		140 000 tpa		30 MWe	Planning permission in 2011. Brickkiln in administration in 2015, present status not known	<a href="https://www.lefastatgraph.co.uk/business/news/derry-waste-site-may-down-enviroparc-put-on-market-by-administrator-31474886.html">https://www.lefastatgraph.co.uk/business/news/derry-waste-site-may-down-enviroparc-put-on-market-by-administrator-31474886.html</a>
69 ESCA	ESCA Graphic board	Hoogezand, NL	LLT	15 MW	Paper rejects	16 tph steam 16 bar	In commissioning	<a href="http://www.eska.com">www.eska.com</a> <a href="http://www.leroulotz.com">www.leroulotz.com</a>
70 Eumyeong		Eumyeong, Korea	Ebara (license)	1*48 tpd	MSW		2009	<a href="http://www.eep.ebara.com">www.eep.ebara.com</a>
71 EUP	EUP CO., Ltd. Ube Branch	Ube City (JP)	Ebara	66 tpd	plastic waste	Ammonia syngas	In op. 2002	<a href="http://www.ube-ind.co.jp/english/news/2005/2005_03.htm">http://www.ube-ind.co.jp/english/news/2005/2005_03.htm</a>
72 Faraday	Robton Kilbride	Hams Hall (UK)	Energos?	150 000 tpa		14.5 MW	In planning	<a href="http://www.roltonkilbride.co.uk/flamshell">www.roltonkilbride.co.uk/flamshell</a>
FasOK Pathfinder	Sierra Energy	Fort Hunter Liggett, CA (USA)	Sierra Energy	20 tpd	MSW, biomass	1 MWe	2017, in commissioning	<a href="http://www.sierraenergy.com">www.sierraenergy.com</a>
73 Fondotce		Fondotce (IT)	Thermoselect	1110 tpd			1992-1999	<a href="http://www.vivacorp.com">www.vivacorp.com</a>
74 Ford Airfield Park	Grundon Circular Technology	Arundel, W. Sussex (UK)	Outotec Energy?	140 000 tpa	RDF	15 MWe	Planning permission 2014. environmental permit 2015.	<a href="http://www.grundon.com">www.grundon.com</a>
75 Forest Park	Amye	Newport Isle of Wight (UK)	Energos 2009, to be phased out	30 000 tpa	Wastes	Power	In operation. to be replaced by a Michalis incinerator in 2019	<a href="https://www.leirecycle.com/news/latest-news/isle-wight-drops-gasification-movable-bed-plant/">https://www.leirecycle.com/news/latest-news/isle-wight-drops-gasification-movable-bed-plant/</a>
76 Fort Parkway Energy	Robton Kilbride Legal & General Property's (LGP) Industrial Property Investment Fund (LPIFI)	Birmingham (UK)	Energos	105 000 tpa	Mixed waste+RDF	8.5 MWe	In planning. CfD contract in 2017	<a href="http://www.roltonkilbride.co.uk/fortparkway">www.roltonkilbride.co.uk/fortparkway</a>
77 Forus		Forus (NO)	Energos		Wastes	CHP	2002	<a href="http://www.energy-group.com/energy-from-waste/">www.energy-group.com/energy-from-waste/</a>
78 Freedom Pine	Lanzatech	Soperton, GA, USA	Concord Blue?			Ethanol	In Planning	<a href="http://www.lanzatech.com">www.lanzatech.com</a> <a href="http://ethanolproducer.com/articles/10934/lanzatech-to-move-headquarters-southern-ethanol-operations-wtecanada.com">ethanolproducer.com/articles/10934/lanzatech-to-move-headquarters-southern-ethanol-operations-wtecanada.com</a>
79 Ft. Greely		Ft. Greely, Alaska (USA)	WTEC	4 tpd	MSW			<a href="http://wtecanada.com">wtecanada.com</a>

Project name	Developer	Location	Gasifier	Capacity	Fuels	Applications	Status	Web page
80) Fujian	Fujian Longlin Group	Longyan City, Fujian (CN)	Kawasaki Heavy Industries	400 tpd*1	Wastes	Cement	Order 2014	<a href="http://www.khi.co.jp/english/kplant/index.html">www.khi.co.jp/english/kplant/index.html</a>
Fukuda		Fukuda, Japan	Nippon Steel & Sumikin Engineering	30 tph	Waste		2007	<a href="http://www.eng.nssc.com">www.eng.nssc.com</a>
81) Fukuroi	Fukuroi City and Mori Town Regional Administration	Fukuroi, Shizuoka Prefecture (JP)	Nippon Steel & Sumikin Engineering	2*66 tpd	MSW, Sludge	1, 7 Mwe	2007	<a href="http://www.eng.nssc.com">www.eng.nssc.com</a>
82) Fukuyama		Fukuyama, Hiroshima (JP)	JFE (Shaft turnae)	13 tph	Waste		2004	<a href="http://www.jfe-eng.co.jp/en/products/environment/">http://www.jfe-eng.co.jp/en/products/environment/</a>
83) Fusui Xinning Conch Cement	Fusui Xinning Conch Cement	Fusui, Guangxi (CN)	Kawasaki Heavy Industries	200 tpd*1	Wastes	Cement	2017	<a href="http://www.khi.co.jp/english/kplant/index.html">www.khi.co.jp/english/kplant/index.html</a>
84) Furih		Furih (DE)	Siemens	2*50 000tpa			1997-1999	
85) Gang Jin		Gang Jin City, S. Korea	Organic Energy	25 tpd	MSW	Heat	2006	<a href="http://organicenergy.ca">organicenergy.ca</a>
86) Gampo		Gampo, Korea	Ebara (license)	2*42 tpd 2012 (Lic.)	MSW		2012	<a href="http://www.eep.ebara.com">www.eep.ebara.com</a>
87) Glamorgan	Enviro Parks Ltd	Glamorgan, Wales (UK)	3 units, grate (CHOPEX)	155 000tpa RDF 83 000 tpa CW			In planning, Present status not known.	<a href="http://www.enviroparks.co.uk">www.enviroparks.co.uk</a>
88) Glasgow	W. H. Malcolm Ltd	Glasgow (UK)	Michalis	4*30 000 tpa	RDF	12 MWe/10 MWh	Planning permission rejected 2016, appeal 2017	<a href="http://www.hearldscotland.com/news/15611890.salt-heap-nation-outrage-over-plans-for-super-incinerator-across-scotland/">www.hearldscotland.com/news/15611890.salt-heap-nation-outrage-over-plans-for-super-incinerator-across-scotland/</a>
89) Gafatrana	Cadence Enviro Power	Limerick, Munster (IE)	PRME	1000 tpd	Wastes	40 Mwe	In planning	<a href="http://www.limerickcleanenergy.com">www.limerickcleanenergy.com</a>
90) Goyang	Goyang City	Goyang, S. Korea	POSCO license Nippon Steel & Sumikin Engineering	2*150 tpd	MSW, Incombustible Residues	5,3 MWe	2010	<a href="http://www.eng.nssc.com">www.eng.nssc.com</a>
91) Great Coates Renewable Energy	Vireol Bio-Industries plc, Future Earth Energy Ltd.	Geat Coates, Grimsby (UK)		165 000 tpd	RDF	18 MWe	Planning permission 2017	<a href="http://www.futureearthenergy.com">www.futureearthenergy.com</a>
92) GreenPower	Green3Power Operations Inc	St. Lucie County, FL, USA	Green3Power Operations	1000 spud MSW		FT	In Planning	<a href="http://www.atmospherecentral.com.uk/news/ham-people-warnings-over-biodiesel-magazine.com/articles/439207/company-to-">www.atmospherecentral.com.uk/news/ham-people-warnings-over-biodiesel-magazine.com/articles/439207/company-to-</a>
93) Greengate Energy Recovery Facility	ESB Asset Development, Pilkington	St. Helens, Merseyside (UK)	Not available Permit refers to "R"	150 000 tpa	RDF	15 MWe	Planning permission 2017	<a href="http://www.esb.ie">www.esb.ie</a> <a href="http://www.mineralwastepanning.co.uk/ew-plant-approved-support-merseyside-employer/energy-from-waste/article/143463">www.mineralwastepanning.co.uk/ew-plant-approved-support-merseyside-employer/energy-from-waste/article/143463</a>
94) GreenSky London	Solena	London (UK)	Solena		sorted MSW	BTL (VeloCYS)	Solena bankrupt 2016	<a href="http://sgblpower.com">sgblpower.com</a>
95) Greve-in-Chianti		Greve-in-Chianti, Florens (IT)	TPS	2*15 MWh	RDF pellets	3,7 MWe	1988-2003	
96) Grimsby Renewable Power Facility	Synnova (Ria Royal Dailman)	Grimsby (UK)	Milana	54 000 tpa	RDF	10 Mwe	Planning permission and environmental permit 2014, project no longer active	<a href="http://www.khi.co.jp/english/kplant/index.html">www.khi.co.jp/english/kplant/index.html</a>
97) Guiding		Guiding, Guizhou (CN)	Kawasaki Heavy Industries	200 tpd*1	Wastes	Cement	2010	<a href="http://www.kobelco-eo.co.jp">www.kobelco-eo.co.jp</a>
98) Haha		Tochiq (JP)	Kobelco	2*3 tph			2014	<a href="http://www.kobelco-eo.co.jp">www.kobelco-eo.co.jp</a>
99) Ham		Ham (DE)	Waste Gen (Tech Trade)				2001-2009	

Project name	Developer	Location	Gasifier	Capacity	Fuels	Applications	Status	Web page
100 Hamada	Hamada District Regional Adm. Ass.	Hamada, Shimane (JP)	JFE (Shaft furnace)	2*2 tph	Waste		2006	<a href="http://www.jfe-eng.co.jp/en/products/environment/">http://www.jfe-eng.co.jp/en/products/environment/</a>
101 Hamatsu		Hamamatsu, Shizuoka	Mitsui	3*150	MSW		2009	<a href="http://www.msc.co.jp">www.msc.co.jp</a>
102 Hamilton	Clean Power Properties	Hamilton, S. Lamerkshire, Scotland (UK)	Not available	3 lines 190 000 tpa	RDF	18 MWe	In planning, planning permission rejected twice	<a href="http://www.cleanpowerproperties.com">www.cleanpowerproperties.com</a> <a href="http://www.mineralwasteprocessing.co.uk/revise-energy-from-waste-proposal-visually-intrusive-council-decides/">www.mineralwasteprocessing.co.uk/revise-energy-from-waste-proposal-visually-intrusive-council-decides/</a> <a href="http://energy-from-waste/article/1499082">energy-from-waste/article/1499082</a>
103 Hanoi	PT. CITRA METRO JAYA ENERGI	Hanoi (VT)	EQTEC	2* 4.5 tph, 2* 6 MWe	MSW		In planning	<a href="http://www.eqtec.com">www.eqtec.com</a> <a href="https://waste-management-world.com/122m-waste-to-energy-qualification-deal-for-entec-in-vietnam">https://waste-management-world.com/122m-waste-to-energy-qualification-deal-for-entec-in-vietnam</a>
104 Harvey	ICM	Harvey County, KS (USA)	ICM	200 tpd	MSW, various		2009-2012	<a href="http://www.icminc.com">www.icminc.com</a>
105 Hata	Hata Regional Municipality Administrative Union	Hata, Kochi (JP)	Nippon Steel & Sumikin Engineering	2*70 tpd	MSW, Incombustible Residues, Sludge	1,8 MWe	2002	<a href="http://www.eng.ussmc.com">www.eng.ussmc.com</a>
106 Hidaka		Hidaka, Hokkaido (JP)	JFE (Shaft furnace)	2*1 tph	Waste		2003	<a href="http://www.jfe-eng.co.jp/en/">http://www.jfe-eng.co.jp/en/</a>
107 Hirajiri	Hirajiri City	Hirajiri, Hyogo (JP)	Nippon Steel & Sumikin Engineering	3*134 tpd	MSW	10 MWe	2010	<a href="http://www.eng.ussmc.com">www.eng.ussmc.com</a>
108 Hirno	Chubu Clean Union	Hirno, Shiba (JP)	Ebara	3*60 tpd	MSW	11 MWe	2007	<a href="http://www.eep.ebara.com">www.eep.ebara.com</a>
109 Hoddesdon	Assescten Partner/ Hoddesdon Energy	Hoddesdon (UK)	Biomass Power Ltd.	96 000 tpa	RDF	10 MWe	Commissioning 2018	<a href="https://www.letsrecycle.com/news/latest-news/testing-starts-hoddesdon-qualification-plant/">https://www.letsrecycle.com/news/latest-news/testing-starts-hoddesdon-qualification-plant/</a>
110 Hoff Sundnes Brenneri	Nord-Trøndelag Energiverk	Sundes (NO)	Organic Energy	20 tpd	RDF	Steam	2001	<a href="http://organicenergy.ca">organicenergy.ca</a>
111 Hollisterburg		Hollisterburg, PA (USA)	Chinook					<a href="http://www.chinooksciences.com">www.chinooksciences.com</a>
112 Hodon Park	Cogen	Hodon, (UK)	Outotec Energy	240 000 tpa	RDF	27 MWe	Due 2018	<a href="http://www.cogenuk.com">www.cogenuk.com</a>
113 Howdon Yard,	Howdon Green Energy Park/ Port of Tyne	Howdon Yard, N. Tyneside (UK)	Not announced	190 000 tpa	MSW	25 MWe	In planning	<a href="http://www.portoftyne.co.uk/business-divisions/estates/howdon-yard-proposed-development/">http://www.portoftyne.co.uk/business-divisions/estates/howdon-yard-proposed-development/</a>
114 Hullburt	US Air Force	Hullburt, FL (USA)	Pyrogenesis	3 100 tpa	MSW, various	0,4 MWe	2010	<a href="http://www.pyrogenesis.com/projects/us-air-force-energyworkshull.co.uk">http://www.pyrogenesis.com/projects/us-air-force-energyworkshull.co.uk</a>
115 Hull	Energy Works Hull	Kingston Upon Hull (UK)	Outotec Energy	240 000 tpa	RDF	28 MWe	In constr., due 2018 CfD	<a href="http://www.energy-works.com/energy-from-waste/">www.energy-works.com/energy-from-waste/</a>
116 Hurum		Hurum (NO)	Energos		Wastes	Heat	In operation 2001-2011	<a href="http://www.energ-group.com/energy-from-waste/">www.energ-group.com/energy-from-waste/</a>
117 Husavik		Husavik, Iceland	WTEC	2*10 tpd	MSW			<a href="http://wtecanada.com">wtecanada.com</a>
118 Hwasung		Hwasung, Korea	Ebara (license)	2*150 tpd	MSW	4,4 MWe	2010	<a href="http://www.eep.ebara.com">www.eep.ebara.com</a>
119 HVC	HVC	Alkmaar, (NL)	Dalhman/ECN	12 MW	Various	CHP	See Ambio project	
120 Ibaraki	Ibaraki City	Ibaraki City, Osaka Prefecture (JP)	Nippon Steel & Sumikin Engineering	300 tpd	MSW, Incombustibles	10 MWe	1980-2011	<a href="http://www.eng.ussmc.com">www.eng.ussmc.com</a>
121 Iberfer	Iberfer	Santiago de Besteros (PT)	Host	5 MW	Chicken litter	CHP	Op. 2011	<a href="http://www.host.nl">www.host.nl</a>

Project name	Developer	Location	Gasifier	Capacity	Feed	Applications	Status	Web page
122 Izuka	Izuka City	Izuka City, Fukuoka Pref (JP)	Nippon Steel & Sumikin Engineering	2*90 tpd	MSW, Incombustible Residues, Sludge	1,2 MWe	1998	
123 Inertec, LLC		Reno (ND), USA	INEOS	300 tpd feed	Biomass, wastes	Ethanol + power	In operation	2003 <a href="http://www.inertec.com">www.inertec.com</a>
124 INEOS Bio	INEOS New Planet BioEnergy	Vero Beach, FL, USA	INEOS	300 tpd feed				<a href="http://www.inesbio.com">www.inesbio.com</a> <a href="http://www.wastetodaymagazine.com/article/ineos-bio-indian-river-bioenergy-sale/">www.wastetodaymagazine.com/article/ineos-bio-indian-river-bioenergy-sale/</a>
125 Inez		Inez, KT	Recycling Solutions	300 tpd				Not available
126 Irvine	BioGen Power	Irvine (UK)	Energos	78 000 tpa	Wastes	Power	In planning, Energos in bankruptcy 2016	<a href="http://www.energy-group.com/energy-from-waste/">www.energy-group.com/energy-from-waste/</a>
127 Iryu	Iryu Health Facilities Administration Union	Iryu, Hyogo Prefecture (JP)	Nippon Steel & Sumikin Engineering	2*60 tpd	MSW, Incombustibles	1,1 MWe	1997	<a href="http://www.eng.nsscnc.com">www.eng.nsscnc.com</a>
128 Isahaya	Kemco Kenan Cleaning Centre (Isahaya (JP))	Isahaya (JP)	JFE (Thermoselect)	3*100 tpd	Wastes	7,5 MWe	2005	<a href="http://www.jfe-eng.co.jp/en/products/energywaste/">http://www.jfe-eng.co.jp/en/products/energywaste/</a>
129 Ishinomaki		Ishinomaki, Magi (JP)	KobeIco	2*5 tpd	Waste			<a href="http://www.kobeico-eco.co.jp">www.kobeico-eco.co.jp</a>
130 Itoshima	Itoshima City	Itoshima City, Fukuoka Pref.	Nippon Steel & Sumikin Engineering	2* 100 tpd	MSW, Incombustibles	3 MWe	2000	<a href="http://www.eng.nsscnc.com">www.eng.nsscnc.com</a>
131 Iwade		Iwade, Wakayama (JP)	KobeIco	2*1,5 tpd	Waste		2008	<a href="http://www.kobeico-eco.co.jp">www.kobeico-eco.co.jp</a>
132 Iwate	Iwate South Coast Environmental Union	Iwate Prefecture (JP)	Nippon Steel & Sumikin Engineering	2*74 tpd	MSW, Cooled Residues	2,5 MWe	2011	<a href="http://www.eng.nsscnc.com">www.eng.nsscnc.com</a>
133 Izumi		Izumi (JP)	JFE (Thermoselect)	4 tpd	Wastes		2005	<a href="http://www.jfe-eng.co.jp/en/products/environment/">http://www.jfe-eng.co.jp/en/products/environment/</a>
134 Izumo		Itoiyagawa (JP)	Eddith process, Hitachi	25 000 tpa	Wastes			
135 Izumo		Izumo (JP)	Concord Blue				Op	<a href="http://www.concordblueenergy.com">www.concordblueenergy.com</a>
136 Izumo		Izumo (JP)	Eddith process, Hitachi	70 000 tpa	Wastes			
137 Jakarta	Procter & Gamble	Jakarta, Indonesia	WTEC	6 tpd	TW			<a href="http://wtecanada.com">wtecanada.com</a>
138 Joetsu	Joetsu Union	Joetsu, Niigata (JP)	Ebara	2* 8 tpd	MSW	0,05 MWe	2000	<a href="http://www.eep.ebara.com">www.eep.ebara.com</a>
139 Joint Base Pearl Harbor-Hickam	US Air Force Research Labs	Honolulu, Hawaii, (USA)	BEST	10 tpd	MSW			2015 <a href="http://bestusa.com">bestusa.com</a>
140 Jose Environment Center	Jose District Wide-Area Municipality Administrative Works Association	Jose, Hibaraki (JP)	Takuma	3*86 tpd	MSW	3 MWe		2012 <a href="http://www.takuma.co.jp">www.takuma.co.jp</a>
141 Kagawa	East Incineration Facilities	Kagawa Pref.	Nippon Steel &	3*65 tpd	MSW, Incombustibles	2,7 MWe	1997	<a href="http://www.eng.nsscnc.com">www.eng.nsscnc.com</a>

Project name	Developer	Location	Gasifier	Capacity	Fuels	Applications	Status	Web page
142 Kakamigahara	Kita Waste Disposal Center,	Kakamigahara, Gifu (JP)	JFE (Shaft furnace)	3*3 tph	Waste		2003	<a href="http://www.jfe-eng.co.jp/en/products/environment/">http://www.jfe-eng.co.jp/en/products/environment/</a>
143 Kakegawa		Kakegawa, Shizuoka (JP) 2005	Takuma	2*70 tpd			2005	<a href="http://www.takuma.co.jp">www.takuma.co.jp</a>
144 Kamashi	Kamashi City	Kamashi City, Iwate (JP)	Nippon Steel & Sumikin Engineering	2*55 tpd	MSW , CFC gases Incombustibles	Hot water recovery	1979-2011	<a href="http://www.eng.nssmc.com">www.eng.nssmc.com</a>
145 Kaneyama	Kaneyama City	Kaneyama City, Mie Prefecture (JP).	Nippon Steel & Sumikin Engineering	3*40 tpd	MSW Incombustibles Landfill Waste	1,25 MWe	2000	<a href="http://www.eng.nssmc.com">www.eng.nssmc.com</a>
146 Kamiina Koki		Japan	Kobelco	2*2,5 tph			In constr. due 2019	<a href="http://www.kobelco-eo.co.jp">www.kobelco-eo.co.jp</a>
147 Kamiso		Kamiso, Hokkaido (JP) 2003	Takuma	2*64 tpd			2003	<a href="http://www.takuma.co.jp">www.takuma.co.jp</a>
148 Karlsruhe		Karlsruhe (DE)	Thermoselet	750 tpd	MSW	Power	1999-2004	<a href="http://www.vivactop.com">www.vivactop.com</a>
149 Kasama		Kasama, Ibaraki (JP)	JFE (Shaft furnace)	2*3 tph	Waste		2006	<a href="http://www.jfe-eng.co.jp/en/products/environment/">http://www.jfe-eng.co.jp/en/products/environment/</a>
150 Kasuno		Kasuno, Aika (JP)	Kobelco	2*3 tph	Waste		2002	<a href="http://www.kobelco-eo.co.jp">www.kobelco-eo.co.jp</a>
151 Kawagoe		Kawagoe, Saitama (JP)	Kobelco	2*5 tph	Waste		2010	<a href="http://www.kobelco-eo.co.jp">www.kobelco-eo.co.jp</a>
152 Kawaguchi	Kawaguchi Asahi Environmental Center	Kawaguchi, Saitama (JP)	Ebara	3*140 tpd	MSW	12 MWe	2002	<a href="http://www.eep.ebara.com">www.eep.ebara.com</a>
153 Kawasaki	Shiwa Denko Corp	Kawasaki, Kawasaki (JP)	EUP (Ebara)	65 000 tpa	plastic waste	Hydrogen for ammonia syngas	2003 Expansion announced 2017	<a href="http://www.eep.ebara.com">www.eep.ebara.com</a> <a href="http://www.sdk.co.j">www.sdk.co.j</a>
154 Kazusa	Kazusa Clean System Co	Kazusa , Chiba Prefecture (JP)	Nippon Steel & Sumikin Engineering		MSW, Incombustible Residues, Sludge	1,5 MWe	2002	<a href="http://www.eng.nssmc.com">www.eng.nssmc.com</a>
155 Kembla Grange,	Wollongong City Council	Wollongong, NSW, Australia	Brightstar Environmental	50 000 tpa	MSW		2001-2004	
156 Killoch Energy	Barr Environmental, Killoch Barron Barron Barron UK)	Killoch, E. Ayrshire Scotland (UK)	Not available (grate?)	2*42 500 tpa	RDF	10 MWe gross	In planning	<a href="http://www.killoch.com">www.killoch.com</a>
157 Kingmoor Park	Verus Ltd., Fortum	Kingmoor park, Carlisle, (UK)	Not available	225 000 tpa	RDF	Power	Planning permission 2016	<a href="http://www.verusenergy.co.uk">www.verusenergy.co.uk</a> <a href="http://www.lestricycle.com/news/latest-news/carlisle-gasification-plant-opens-danimo-advoc/">www.lestricycle.com/news/latest-news/carlisle-gasification-plant-opens-danimo-advoc/</a>
158 Kingspan	Kingspan Insulation Ltd,	Selly (UK)	Not available	132 000 tpa	RDF	14 MWe	Permit 2017	
159 Kita-Kyushu	Kita-Kyushu Eco Energy Co	Kita-Kyushu, Fukuoka Prefecture (JP)	Nippon Steel & Sumikin Engineering	2*160 tpd	Industrial Waste, ASR	14 MWe	2005	<a href="http://www.eng.nssmc.com">www.eng.nssmc.com</a>
160 Kitagoya	Kitagoya Clean System C	Nagoya, Aichi Prefecture (JP)	Nippon Steel & Sumikin Engineering	2*330 tpd	MSW, Incombustible Residues	20 MWe	2020	<a href="http://www.eng.nssmc.com">www.eng.nssmc.com</a>
161 Knowsley Park		Knowsley (UK)	Energos	95 000 tpa	Wastes	Power	In planning, Energos in	
162 Kobuko		Kobuko, Kagoshima (JP)	Takuma	2*81 tpd			2003	<a href="http://www.takuma.co.jp">www.takuma.co.jp</a>

Project name	Developer	Location	Gasifier	Capacity	Fuels	Applications	Status	Web page
163 Kohi-Kyoto		Kyoto, Yamanaishi Prefecture (JP)	Kobeeco	3*5 tph				2017 <a href="http://www.kobeeco-ecc.co.jp">www.kobeeco-ecc.co.jp</a>
164 Koga		Koga city (JP)	Mitsui	2*3 tph	Waste			2003 <a href="http://www.msc.co.jp">www.msc.co.jp</a>
165 Koki		Yamagata (JP)	Kobeeco	2*3 tph			In constr. due 2018	<a href="http://www.kobeeco-ecc.co.jp">www.kobeeco-ecc.co.jp</a>
166 Komaki	Komaki Health Union	Aichi Prefecture (JP)	Nippon Steel & Sumikin Engineering	2*98.5 tpd	MSW, Incombustible Residues	4.3 MWe		2015 <a href="http://www.eng.nssm.com">www.eng.nssm.com</a>
167 Kurahama Ecotopia Ikehara	Kurahama Hygiene Facilities Union Ecotopia Ikehara	Kurama, Okinawa (JP)	Ebara	3*103 tpd	MSW	6 MWe		2010 <a href="http://www.eep.ebara.com">www.eep.ebara.com</a>
168 Kurashiki	Mitsushima Eco works Co	Kurashiki (JP)	JFE (Thermoselect)	2*15 tph	Waste			2005 <a href="http://www.jfe-eng.co.jp/en/products/environment/">http://www.jfe-eng.co.jp/en/products/environment/</a>
169 Kurabe	Nikko Mikkaichi Recycling Co. Ltd.	Kurabe, Toyama (JP)	Ebara	1*63 tpd	ASR, waste plastic			2002 <a href="http://www.eep.ebara.com">www.eep.ebara.com</a>
170 Kushiro		Kushiro City, Hokkaido (JP)	Mitsubishi	2*120 tpd	Waste	4.6 MWe		2006 <a href="http://www.eep.ebara.com">www.eep.ebara.com</a>
171 Kwajalein	US Army	Kwajalein Atoll, Marshall Islands (USA)	WTEC	38 tpd				<a href="http://www.wtecanada.com">wtecanada.com</a>
172 KymiJärvi I	Lahti Energia Oy	Lahti (FI)	Foster-Wheeler 1997	70 MW	Wood residues	Indirect co-firing	In op. 1997-2018	<a href="http://www.sh-fw.com">www.sh-fw.com</a> <a href="http://www.lahtienergia.fi/">www.lahtienergia.fi/</a>
173 KymiJärvi II	Lahten Lampovoima Oy	Lahti (FI)	Metsä 2012	2*80 MW	SRF (wastes)	CHP	In op. 2012	<a href="http://www.lahtigasification.com">www.lahtigasification.com</a> <a href="http://www.valmet.com">www.valmet.com</a>
174 Kyouku		Kyouku (JP)	Mitsui	2*2 tph				2003 <a href="http://www.msc.co.jp">www.msc.co.jp</a>
175 Lake County Waste-to-Ethanol	Powers Energy 1	Lake County, IN, USA		2000-10000 spd to ethanol			Cancelled	<a href="http://www.biofuelstogest.com/biofest/2012/02/08/5-indiana-waste-to-ethanol-project-dead/">http://www.biofuelstogest.com/biofest/2012/02/08/5-indiana-waste-to-ethanol-project-dead/</a>
176 Lebanon WTE Gasification Project	City of Lebanon	Lebanon, TN, USA	Aires Clean Energy Aia PHG Energy	64 spd,	SRF tyres, sludge	0.4 MWe		2016 <a href="http://airescleanenergy.com">airescleanenergy.com</a>
177 Levensaet	Levensaet Renewable Energy	Fordh, Lanark, (UK)	Olthec Energy	105 000 tpa	RDF	11 MWe/16 MWh th		2017 <a href="http://reil.levensaet.co.uk/">http://reil.levensaet.co.uk/</a>
178 Lida	Mitsumi-Shinshu Union	Lida, Nagano (JP)	Ebara	2*47 tpd	MSW	0.4 MWe		2003 <a href="http://www.eep.ebara.com">www.eep.ebara.com</a>
179 Lincoln		Lincoln County, Wyoming	WTEC	2tpd	MSW			<a href="http://wtecanada.com">wtecanada.com</a>
180 Lingyun	Guangxi Lingyun Tonghong Cement	Lingyun, Guangxi Zhuang (CN)	Kawazaki Heavy Industries	100 tpd*1	Wastes	Cement		2017 <a href="http://www.khi.co.jp/english/kjant/index.html">www.khi.co.jp/english/kjant/index.html</a>

Project name	Developer	Location	Gasifier	Capacity	Fuels	Applications	Status	Web page
181 Lisburn	Lisburn Energy Recovery	Lisburn (UK)	Energis	80 000 tpa	Wastes	Power	In planning, Energis bankruptcy	
182 Loomie	CHO Power	Loomie (FR)	CHO Power	45 000 tpa	Sorted MSW	11 MWe	In planning	<a href="http://www.choloomie.fr/">www.choloomie.fr/</a>
183 Los Angeles	Intrastate Waste	Los Angeles County (USA)	Thermoselect + Lanzatech	560 000 tpa	MSW	150 000 m <sup>3</sup>	In planning	<a href="http://www.ikonline.com/home.html">http://www.ikonline.com/home.html</a>
184 Lostock Works	Tata Chemicals Ltd.	Northwich		600 000 tpa		90 MWe	Planning permit, 30 MWe in 2012	<a href="http://www.lostockpower.co.uk">www.lostockpower.co.uk</a>
185 Maglie	Maglie	Crotia	WTEC	3 tpd	MSW			<a href="http://wtecanalia.com">wtecanalia.com</a>
186 Mahad		Mahad (IN)	Concord Blue			hydrogen	Op	<a href="http://www.concordblueenergy.com">www.concordblueenergy.com</a>
187 Malagotta	Gruppo Colan?, SCA Group	Rome (IT)	WGM Thermoselect	75 000 tpa	Plastic, tyres		2008-2012	<a href="http://www.colan.it/ty/page/72.aspx">http://www.colan.it/ty/page/72.aspx</a>
188 Massachusetts	Intrastate Waste Technologies	Massachusetts (USA)	Thermoselect + Lanzatech	560 000 tpa	MSW	150 000 m <sup>3</sup> ethanol	In planning	<a href="http://www.ikonline.com/home.html">http://www.ikonline.com/home.html</a>
189 Matsue	Matsue City	Matsue, Shimane Prefecture (JP)	Nippon Steel & Sumikin Engineering	3 85 tpd	MSW, Incombustible Residues, sludge	4, 5 Mwe		2011 <a href="http://www.eng.nssrrc.com">www.eng.nssrrc.com</a>
190 Mihara-Nakata		Mihara-Nakata (JP)	Hitachi, AtherNMG	1 tpd	Wastes	Power	Op, 2002	<a href="http://www.athermg.com">www.athermg.com</a>
191 Millenium EW	Millenium EW / Clincock Urban Mining, Althar)	Bulwell, Nottingham (UK)	Chinook	160 000 tpa	Wastes	25 MWe	Planning permission 2016	<a href="http://www.chinooksciences.com">www.chinooksciences.com</a>
192 Milton Keynes	Arey/Cespa	Milton Keynes (UK)	Energis	96 000 tpa	RDF	7.7 Mwe	In commissioning	<a href="http://www.endwasteandblueenergy.com/article/140381/go-ahead-wasteservices.amey.co.uk/where-we-work/milton-keynes">www.endwasteandblueenergy.com/article/140381/go-ahead-wasteservices.amey.co.uk/where-we-work/milton-keynes</a>
193 Miami-Shinsu Kibayashi Clean Center	Miami-Shinsu Integrated Region Association	Miami-Shinsu (JP)	Ebara		Waste		Op	<a href="http://www.ebar.com">www.ebar.com</a>
194 Minden	AML Immobilien GmbH	Minden (DE)	Energis		Wastes	Heat	2001-	<a href="http://www.energy-group.com/energy-from-waste/">www.energy-group.com/energy-from-waste/</a>
195 Monroe	Energy3 LLC.	Monroe county, FL (USA)	Chinook		Yard wastes	Power	In planning	<a href="http://www.waste360.com/yard-waste/florida-keys-na-approve-gasification-yard-waste">http://www.waste360.com/yard-waste/florida-keys-na-approve-gasification-yard-waste</a>
196 Moor Street	Clean Power Properties Ltd.	Dudley (UK)		100 000 tpa		6 MWe	Environmental permit withdrawn by the company 2017	<a href="http://www.cleanpowerproperties.com">www.cleanpowerproperties.com</a>
197 Morcenx	CHOPower	Morcenx (FR)	CHO	55 000 tpa	waste wood, sorted MSW	11 MWe	In operation 2010	<a href="http://www.cho-power.com">www.cho-power.com</a>
198 Moritaka-Shiwa		Moritaka-Shiwa, Iwate (JP)	JFE (Shaft furnace)	2*3 tpd	Waste			2003 <a href="http://www.jfe-eng.co.jp/en/products/environment/products/environment/">http://www.jfe-eng.co.jp/en/products/environment/</a>
199 Movlisa	Movlisa	Campo Criollo (ES)	Ertec	5.9 MWE	Biomass waste	CHP	In operation	<a href="http://www.ertec.es">ertec.es</a> <a href="http://www.ertec.com">ertec.com</a>
200 Murakata	Genkal Environmental Union	Fukushima Prefecture (JP)	Nippon Steel & Sumikin Engineering	2*80 tpd	MSW, Incombustible Residues	2.4 MWe		2003 <a href="http://www.eng.nssrrc.com">www.eng.nssrrc.com</a>
201 Mumbai		Mumbai (IN)	Concord Blue				Op	<a href="http://www.concordblueenergy.com">www.concordblueenergy.com</a>
202 Matsui	AX Green	Matsui (JP)	JFE (Thermoselect)	8 tpd	Waste			2003 <a href="http://www.jfe-eng.co.jp/en/products/environment/">http://www.jfe-eng.co.jp/en/products/environment/</a>

Project name	Developer	Location	Gasifier	Capacity	Fuels	Applications	Status	Web page
203 Nagayama	Nagayama City Clean	Nagayama, Chiba (JP)	Ebara	3*69 tpd	MSW			2004 <a href="http://www.ebara.com">www.ebara.com</a>
204 Nagasaki	Kenou Kemari Association	Nagasaki (JP)	JFE (Thermoselect)	15 tpd	Waste	3 MWe		2005 <a href="http://www.jfe-eng.co.jp/en/products/environment/">http://www.jfe-eng.co.jp/en/products/environment/</a>
205 Nagoya Works	Nippon Steel & Sumitomo Metal Corporation	Nagoya, Aichi Prefecture (JP)	Nippon Steel & Sumikin Engineering	2*120 tpd	ASR	Steam		2006 <a href="http://www.eng.nssmc.com">www.eng.nssmc.com</a>
206 Nakatsugawa		Nakatsugawa (JP)	Kobeeco	2*4 tpd	Waste			2004 <a href="http://www.kobeeco.co.jp">www.kobeeco.co.jp</a>
207 Namyangju	City of Namyangju	Namyangju S Korea	HitechZosen		Wastes		In operation	<a href="http://www.hitechzosen.co.jp">www.hitechzosen.co.jp</a>
208 Namyangju		Namyangju S Korea	Hitech Zosen		Waste			<a href="http://www.hitechzosen.co.jp">www.hitechzosen.co.jp</a>
209 Nanjing	Nanjing Conch Cement	Nanjing, Sichuan (CN)	Kawazaki Heavy Industries	200 tpd*1	Wastes	Cement		2016 <a href="http://www.khi.co.jp/english/kohat/index.html">www.khi.co.jp/english/kohat/index.html</a>
210 Narashino	Narashino City	Narashino, Chiba Prefecture (JP)	Nippon Steel & Sumikin Engineering	2*73 tpd	MSW, Incombustible Residues, Sludge	2.4 MWe		2002 <a href="http://www.eng.nssmc.com">www.eng.nssmc.com</a>
211 Narumi	Narumi Clean System Co	Nagoya, Aichi (JP)	Nippon Steel & Sumikin Engineering	2*265 tpd	MSW, Incombustibles, Incineration Residues	9 MWe		2009 <a href="http://www.eng.nssmc.com">www.eng.nssmc.com</a>
212 Nemuro-Hokubu		Nemuro-Hokubu, Hokkaido (JP)	Kobeeco	2*1.5 tpd	Waste			2007 <a href="http://www.kobeeco.co.jp">www.kobeeco.co.jp</a>
213 New Lodge Fram	Clean Power Properties Ltd.	Cwmgwill, UK	Prolysis technology, n.a.	128 000 tpa		8-12 Mwe	Planning permission refused in 2016	<a href="http://www.cleanpowerproperties.com">www.cleanpowerproperties.com</a>
214 Newport Docks	Biogen	Newport (UK)	Energos	120 000 tpa	Wastes	Power	Under Energos in bankruptcy	<a href="http://www.energy-group.com/energy-from-waste/">www.energy-group.com/energy-from-waste/</a>
215 Niigajo	Niigajo Conch Cement	Niigajo, Aichi (CN)	Kawazaki Heavy Industries	300 tpd*1	Wastes	Cement		2018 <a href="http://www.khi.co.jp/english/kohat/index.html">www.khi.co.jp/english/kohat/index.html</a>
216 Nishi Ibari		Nishi Ibari (JP)	Mitsui	2*2 tpd	Waste			2003 <a href="http://www.mes.co.jp">www.mes.co.jp</a>
217 Nishikigawa		Tokyo City (JP)	Kobeeco	2*2.5 tpd				2014 <a href="http://www.kobeeco.co.jp">www.kobeeco.co.jp</a>
218 Nihiyara	Shizuoka City	Shizuoka, Shizuoka Prefecture (JP)	Nippon Steel & Sumikin Engineering	2* 250 tpd	MSW, Crushed Residues	14 MWe		2010 <a href="http://www.eng.nssmc.com">www.eng.nssmc.com</a>
219 Nong Bua		Nong Bua, Thailand	GRE		Biomass+ RDF	4 MWth, 1 MWe		2017 <a href="http://www.gussingrenewable.com">www.gussingrenewable.com</a>
220 Northampton	Northampton Community Energy Scheme	Northampton (UK)	Kobeeco		RDF	23 MWe	In planning	<a href="http://www.kobeeco-eco.co.jp">www.kobeeco-eco.co.jp</a>
221 Oita	Oita City	Oita, Oita Prefecture (JP)	Nippon Steel & Sumikin Engineering	3*129 tpd	MSW, Sludge	1, 9 MWe		2003 <a href="http://www.eng.nssmc.com">www.eng.nssmc.com</a>
222 Okayama	Mitsubishi Eco-Works Corp.	Okayama (JP)	JFE (Thermoselect)	20 tpd	Wastes			2005 <a href="http://www.jfe-eng.co.jp/en/products/environment/">http://www.jfe-eng.co.jp/en/products/environment/</a>



Project Name	Developer	Location	Gasifier	Capacity	Fuels	Applications	Status	Web page
223 Okazaki	Okazaki City	Okazaki, Aichi Prefecture (JP)	Nippon Steel & Sumikin Engineering	3* 190 tpd	MSW, Incineration Residues Sludge	10.5 MWe	2011	<a href="http://www.eng.nssc.com">www.eng.nssc.com</a>
224 Old Crow		Old Crow, Yukon, (CA)	WTEC				2012	<a href="http://wtecanada.com">wtecanada.com</a>
225 Omura	JBEC	Omura (JP)	Concord Blue					<a href="http://www.concordblueenergy.com">www.concordblueenergy.com</a>
226 Ono-Katsuyama		Ono-Katsuyama, Fukui (JP)	KobeIto	2*2 tpd	waste	0.5 MWe	2006	<a href="http://www.kobeito-eco.co.jp">www.kobeito-eco.co.jp</a>
227 Onshbruck		Onshbruck (DE)	EQTEC				In construction	<a href="http://eqtec.es">eqtec.es</a> <a href="http://eqtecdk.com">eqtecdk.com</a>
228 Baji Engyon New Town, S. Korea	Korean National Housing Corp.	S. Korea	KobeIto (licensing)	2* 2tpd	Waste		2009	<a href="http://www.kobeito-eco.co.jp">www.kobeito-eco.co.jp</a>
229 Pangyo Clean Tower	Korean Land Corporation	S. Korea	KobeIto (licensing)	2* 2tpd	Waste		2011	<a href="http://www.kobeito-eco.co.jp">www.kobeito-eco.co.jp</a>
230 Pectoli		Pectoli, (IT)	WTEC	5 tpd	Mixed wastes		2006	<a href="http://wtecanada.com">wtecanada.com</a>
231 Peterborough Renewable Energy Park (Green Energy Parks)	Peterborough Energy Park (Green Energy Parks)	Ferriam, Peterborough (UK)	Biomass Power?	79 MWe	RDF		Planning permission 2016	<a href="http://www.greenenergyparks.co.uk/">www.greenenergyparks.co.uk/</a>
232 Pingliang	Pingliang Conch Cement	Pingliang City, Gansu	Kawasaki Heavy Industries	300 tpd*1	Wastes	Cement	2013	<a href="http://www.khi.co.jp/english/kdant/index.html">www.khi.co.jp/english/kdant/index.html</a>
233 Plainfield			Outotec Energy	37 MWe				<a href="http://www.outotec.com">www.outotec.com</a> <a href="http://www.energyproducts.com">www.energyproducts.com</a> <a href="http://www.dtc-power.com">www.dtc-power.com</a>
234 Pohler	CHO Power	Pohler (FR)	CHOPower					
235 Polnadle, Glasgow	Vindor	Glasgow (UK)	Energos	144 000 tpa	Wastes	Power	Cancelled 2016 Incinerator in constr.	
236 Protos	Ince Bio Power Cogent/Peel Environmental	Ince Park, Eilsmere port (UK)	Outotec Energy	170 000 tpa	Recycle wood etc.	22 MWe	In constr., due 2017	<a href="http://www.cogenuk.com/projects/ince-bio-power">www.cogenuk.com/projects/ince-bio-power</a> <a href="http://www.peelenvironmental.co.uk">www.peelenvironmental.co.uk</a>
237 Protos	Peel Environmental	Ince Park, Eilsmere port (UK)	PowerHouse Energy Group	25 tpd			In planning	<a href="http://www.peelenvironmental.co.uk">www.peelenvironmental.co.uk</a> <a href="http://www.powerhouseenergy.net">www.powerhouseenergy.net</a>
238 Pune		Pune (IN)	Concord Blue				In operation	<a href="http://www.concordblueenergy.com">www.concordblueenergy.com</a>
239 Pune	Maharashtra Enviro Power Limited	Pune (JP)	AlterNRG	3 tpd	Haz. Wastes	Power	Op. 2009	<a href="http://www.alternrg.com">www.alternrg.com</a>
240 Qingzhen	Qingzhen Conch Cement	Qingzhen City, Guizhou (CN)	Kawasaki Heavy Industries	300 tpd*1	Wastes	Cement	2015	<a href="http://www.khi.co.jp/english/kdant/index.html">www.khi.co.jp/english/kdant/index.html</a>
241 Qiyang	Qiyang Conch Cement	Qiyang, Hunan (CN)	Kawasaki Heavy Industries	300 tpd*1	Wastes	Cement	2015	<a href="http://www.khi.co.jp/english/kdant/index.html">www.khi.co.jp/english/kdant/index.html</a>
242 Ransheim	Energos Ransheim	Ransheim (NO)	Energos 1997		Wastes	Heat	1997-2010	<a href="http://www.energ-group.com/energy-from-waste/">www.energ-group.com/energy-from-waste/</a>
243 Redruth	Redruth Env. Ltd.	Redruth, UK	n. a.		Wastes	8 MWe	In Planning Received Cfb contract 2017, but changed to plant-drops-cfb-process	<a href="https://www.endswasteandbioenergy.com/article/1447066/efw-plant-drops-cfb-process">https://www.endswasteandbioenergy.com/article/1447066/efw-plant-drops-cfb-process</a>
244 Reliance Energy Melton Hill	Reliance Energy	Hull (UK)	EQTEC	120 000 tpa	Wastes	16 MWe	In planning	<a href="http://www.relianceenergy.eu">www.relianceenergy.eu</a> <a href="http://eqtec.es">eqtec.es</a> <a href="http://entrac.com">entrac.com</a>

Project name	Developer	Location	Gasifier	Capacity	Fuels	Applications	Status	Web page
245 Reliance Energy Seals Sands	Reliance Energy	Newcastle (UK)	EQTec	72 000 tpa		12 MWe	In planning	<a href="http://www.relianceenergy.eu/eqt/eces">www.relianceenergy.eu/eqt/eces</a>
246 Riverside Industrial Plant	Biomass UK No. 3	Riverside, Boston (UK)	Staged FB ?	84 000 tpa	wood, sludge	12 MWe	Operational	<a href="https://www.letsrecycle.com/news/latest-news/boston-biomass-approves-rmw-consults-harry">https://www.letsrecycle.com/news/latest-news/boston-biomass-approves-rmw-consults-harry</a>
247 Rotherham	Rotherham Kilnride	Rotherham (UK)	Not available	215 000 tpa		23 MWe	In planning	<a href="http://www.rotherhamkilnride.co.uk/rotherham">http://www.rotherhamkilnride.co.uk/rotherham</a>
248 Rüdersdorf	CEMEX Deutschland	Rüdersdorf bei Berlin (DE)	Envirotech (Fka Lurgi)	25 tph total, 15-20 tph sec. fuels (135,000 tpa)	Coal ash + RDF	Gas to cement kiln	1996	<a href="http://www.cemex.de">www.cemex.de</a>
249 Saga	Eco Association of the West Saga	Saga Prefecture (JP)	Nippon Steel & Sumikin Engineering	2*102.5 tpd	MSW, Incombustibles	4.4 MWe	2015	<a href="http://www.eng.nssmc.com">www.eng.nssmc.com</a>
250 Sagamihara		Sagamihara, Kanagawa (JP)	Kobelco	2*7 tph			2010	<a href="http://www.kobelco-eco.co.jp">www.kobelco-eco.co.jp</a>
251 Sakai	Eco Center Banjo	Sakai, Oita (JP)	JFE (Shaft furnace)	2*2 tph	Waste		2003	<a href="http://www.jfe-eng.co.jp/en/products/environment/">http://www.jfe-eng.co.jp/en/products/environment/</a>
252 Sainokuni	Sainokuni Thermal Recycle Facility	Sainokuni (JP)	JFE (Thermoselect)	3 MWe	Waste		2006	<a href="http://www.jfe-eng.co.jp/en/products/environment/">http://www.jfe-eng.co.jp/en/products/environment/</a>
253 Satama	Satama City	Satama, Satama Prefecture (JP)	Nippon Steel &	8.5 MWe	MSW, Incombustible		2015	<a href="http://www.eng.nssmc.com">www.eng.nssmc.com</a>
254 Sakai	Sakai Clean System Co.	Sakai, Osaka Prefecture (JP)	Nippon Steel & Sumikin Engineering	2*225 tpd	MSW	13.5 MWe	2013	<a href="http://www.eng.nssmc.com">www.eng.nssmc.com</a>
255 Sakata	Sakata Area Clean Union	Sakata, Yamagata (JP)	Ebara	2*98 tpd	MSW	2 MWe	2002	<a href="http://www.eep.ebara.com">www.eep.ebara.com</a>
256 Sarsborg (NO)	Borregaard Sarsborg Energiøvinning	Sarsborg (NO)	Energos 2010	40 MW	Wastes	Heat	In operation	<a href="http://www.energy-group.com/energy-from-waste/">www.energy-group.com/energy-from-waste/</a>
257 Sarsborg (NO)	Hafslund Borregaard Wte	Sarsborg (NO)	Energos 2002	2*15 MW	Wastes	Heat	In operation	<a href="http://www.energy-group.com/energy-from-waste/">www.energy-group.com/energy-from-waste/</a>
258 Sasima		Sasima, Ibaraki (JP)	Kobelco	2*4 tph	Waste		2008	<a href="http://www.kobelco-eco.co.jp">www.kobelco-eco.co.jp</a>
259 Scarborough	Scarborough Power	Scarborough(UK)	GEM flash pyrolysis	15 000-25 000 tpa	RDF		2009-2011	Not available
260 Senoh	Senoh Environmental Maintenance Union	Gifu Prefecture (JP)	Nippon Steel & Sumikin Engineering	2*90 tpd	MSW, Incineration Residues	Hot water	2004	<a href="http://www.eng.nssmc.com">www.eng.nssmc.com</a>
261 Seki	Chuno Union	Seki, Gifu (JP)	Ebara	3*56	MSW	2 MWe	2003	<a href="http://www.eep.ebara.com">www.eep.ebara.com</a>
262 Seman		Seman, Miyagi Prefecture, (JP)	Kobelco	2*4 tph			2017	<a href="http://www.kobelco-eco.co.jp">www.kobelco-eco.co.jp</a>
263 Setagaya	Clean Association of Tokyo	Tokyo (JP)	Kawasaki Heavy Industries	2*150 tpd		Power	2010	<a href="http://www.khi.co.jp/english/khanf/index.html">www.khi.co.jp/english/khanf/index.html</a>
264 Severn Bridge		Portskewett, Cardiff (UK)	DPS Process Solution	20 000 tpa	MSW		Planning, DPS bankrupt 2018	
265 Shale	Shuangji Cement	Shale City, Hebei	Kawasaki Heavy Industries	300 tpd*1	Wastes	Cement	2018	<a href="http://www.khi.co.jp/english/khanf/index.html">www.khi.co.jp/english/khanf/index.html</a>
266 Shale	Shuangji Cement	Shale City, Hebei	Kawasaki Heavy Industries	300 tpd*1	Wastes	Cement	2018	<a href="http://www.khi.co.jp/english/khanf/index.html">www.khi.co.jp/english/khanf/index.html</a>
267 Shiga		Shiga (JP)	Kawasaki Heavy Industries	2*37.5tpd		Power	Operational	<a href="http://www.khi.co.jp/english/khanf/index.html">www.khi.co.jp/english/khanf/index.html</a>

Project name	Developer	Location	Gasifier	Capacity	Feed	Applications	Status	Web page
268 Shimada	Shimada City	Shimada, Shizuoka Prefecture (JP)	Nippon Steel & Sumikin Engineering	2*74 tpd	MSW, Incombustible Residues Sludge	2 Mwe	2006	<a href="http://www.eng.nsscnc.com">www.eng.nsscnc.com</a>
269 Shimen	Shimen Conch Cement	Shimen, Hunan (CN)	Kawasaki Heavy Industries	200 tpd*1	Wastes	Cement	2016	<a href="http://www.khi.co.jp/english/kplant/index.html">www.khi.co.jp/english/kplant/index.html</a>
270 Shin-roji	Kita-kyushu City	Kita-kyushu, Fukuoka Prefecture (JP)	Nippon Steel & Sumikin Engineering	3*240 tpd	MSW, Incombustibles, Sludge	23.5 Mwe	2007	<a href="http://www.eng.nsscnc.com">www.eng.nsscnc.com</a>
271 Shizukushi T	Shizukushi Takizawa Environmental Union	Shizukushi, Iwate Prefecture (JP)	Nippon Steel & Sumikin Engineering	2*50 tpd	MSW Incombustibles	1.2 MWe	2002	<a href="http://www.eng.nsscnc.com">www.eng.nsscnc.com</a>
272 Shuangfeng	Shuangfeng Conch Cement	Shuangfeng, Hunan (CN)	Sumikin Engineering	200 tpd*1	Wastes	Cement	2016	<a href="http://www.khi.co.jp/english/kplant/index.html">www.khi.co.jp/english/kplant/index.html</a>
273 Shucheng	Shucheng Conch Cement	Shucheng, Guizhou (CN)	Kawasaki Heavy Industries	200 tpd*1	Wastes	Cement	2016	<a href="http://www.khi.co.jp/english/kplant/index.html">www.khi.co.jp/english/kplant/index.html</a>
274 Sierra Biofields Plant	Fulcrum BioEnergy	Macaran, NY, USA	TRI	200 000 tpa 226M\$	MSW	FT		<a href="http://www.inretec.com">www.inretec.com</a>
275 Sifm Integrated Waste Treatment Centre	RRS	Derby (UK)	Energos	140 000 tpa	RF+mixed waste	11 MWe	Operational 2018	<a href="http://www.rtsderbyshire.net">www.rtsderbyshire.net</a>
276 Skelton Grange	Chinook Urban Mining	Leeds (UK)	Chinook	180 000 tpa			In planning	<a href="http://www.chinooksciences.com">www.chinooksciences.com</a>
277 South Marston	Robton Kibrite	South Marston, Swindon (UK)	Not available	150 000 tpa	RF	15 MWe	Planning permission rejection appealed in 2017	<a href="http://www.robtonkibrite.co.uk/swindon">www.robtonkibrite.co.uk/swindon</a>
278 Station Yard CFD 1	DC2 Engineering Ltd.	Wales (UK)	n.a.	n.a.	n.a.	0.05 MWe	In planning CfD contract 2017.	<a href="http://dc2engineering.co.uk/">dc2engineering.co.uk/</a>
279 Stores Road	DREML Ltd	Cotby (UK)	Biomass Power	80 000 tpa	MSW	12 MWe	Planning permission 2014. Variation application 2015	<a href="http://www.dreml.co.uk">www.dreml.co.uk</a>
280 Sunderland	Robton Kibrite	Sunderland (UK)	n.a.			27 MWe	In planning	<a href="http://www.robtonkibrite.co.uk/sunderland">www.robtonkibrite.co.uk/sunderland</a>
281 SVZ	Suset SVZ Schwarze Pumpe	Schwarze Pumpe (DE)	Envirothem (for BGI)	200 000 tpa	RF co-gasification w. coal, lignite		2006-2007	
282 SWNOV Déchets	SWNOV Déchets	Villiers-sous-Montrond, FR	LLT	45 tpd 56/90 GWh	SRF, waste wood		In construction	<a href="http://www.lerouxkiz.com">www.lerouxkiz.com</a> <a href="http://www.endswasteandbioenergy.com/article/1414609/multi-fuel-gasification-plant-revealed">www.endswasteandbioenergy.com/article/1414609/multi-fuel-gasification-plant-revealed</a>
283 Synthesis HVC Alkmaar	HVC	Alkmaar, NL	Dahman (ECN Milena)		Biomass, wastes	CHP later SNG	See Ambiqo project	
284 Tachiyagawa Energy Recovery	Yamagata Area Environmental Office	Yamagata prefecture (JP)	MHIEC	2*75 tpd	MSW	Power	2017	<a href="https://waste-management-world.com/6150m-waste-to-energy-gasification-order-for-mitsubishi-in-japan">https://waste-management-world.com/6150m-waste-to-energy-gasification-order-for-mitsubishi-in-japan</a>
285 Tajimi	Tajimi City	Tajimi, Gifu Prefecture (JP)	Nippon Steel & Sumikin Engineering	2*85 tpd	MSW, Incombustible Residues, Sludge	2 MWe	2003	<a href="http://www.eng.nsscnc.com">www.eng.nsscnc.com</a>
286 Taylor Biomass	Taylor Recycling	Montgomery NV USA	Taylor (Batalie)		Wastes	21 MWe		<a href="http://www.taylorbiomassenergy.com">www.taylorbiomassenergy.com</a>
287 Teeside	Air Products	Teeside (UK)	Albemarrg	2*350 000 tpa feed	sorted MSW	2*50 MWe	2016, idle	<a href="http://www.airproducts.co.uk/microsite/uk/teesvalley/index.htm">http://www.airproducts.co.uk/microsite/uk/teesvalley/index.htm</a> <a href="http://www.albemarrg.com">www.albemarrg.com</a>

Project name	Developer	Location	Gasifier	Capacity	Fuels	Applications	Status	Web page
288 Thai project		Thailand	Synova (Malaya)	30 MW th input				<a href="http://synovapower.com">synovapower.com</a>
289 Tronton Science Park		Ince, Cheshire, (UK)	PowerHouse Energy Group	25 tpd			2017	<a href="http://www.powerhouseenergy.net">www.powerhouseenergy.net</a>
290 Thora		Coffs Harbor, Victoria (AU)	WTEC	200 tpd	IW			<a href="http://wtecanada.com">wtecanada.com</a>
291 Tiger	CHO Power	Thouars (FR)	CHO Power	45 000 tpa	sorted MSW	10 MWe	Planning	<a href="http://www.chopier.fr/">http://www.chopier.fr/</a>
292 Tohatsisei	Tohatsisei Union	Tohatsisei, Mie Prefecture (JP)	Nippon Steel & Sumikin Engineering	2*48 tpd	MSW, Incombustible Residues	1.2 MWe	2014	<a href="http://www.eng.rsscnc.com">www.eng.rsscnc.com</a>
293 Tobuchita	Tobuchita Health Union	Tobuchita, Aichi (JP)	Nippon Steel & Sumikin Engineering	2*100 tpd	MSW, sludges	4.5 MWe	2019	<a href="http://www.eng.rsscnc.com">www.eng.rsscnc.com</a>
294 Tokushima	Chuoai Kokui Env. Union	Tokushima (JP)	JFE (Thermosect)	2*60 tpd	Wastes		2005	<a href="http://www.jfe-eng.co.jp/en/products/environment/">http://www.jfe-eng.co.jp/en/products/environment/</a>
295 Tokyo	Tokyo Kinikai Recycle Power	Tokyo City (JP)	Ebara	2*275 tpd	Plastic waste, CDW	23 MWe	2006	<a href="http://www.eep.ebara.com">www.eep.ebara.com</a>
296 Tokyo Setagaya		Setagaya, Tokyo City (JP)	Kawasaki Heavy Industries	300 tpd	MSW	6.75 MWe		<a href="http://www.khi.co.jp/english/kpbanf/index.html">www.khi.co.jp/english/kpbanf/index.html</a>
297 Tongling	Tongling Conchi Cement	Tongling City, Anhui (CN)	Kawasaki Heavy Industries	300 tpd*1 300 tpd*1	Wastes	Cement	2010	<a href="http://www.khi.co.jp/english/kpbanf/index.html">www.khi.co.jp/english/kpbanf/index.html</a>
298 Toyoada Aichi		Toyoada Aichi (JP)	Hitachi zosen		Waste		In operation	<a href="http://www.hitachizosen.co.jp">www.hitachizosen.co.jp</a>
299 Toyohashi		Toyohashi, Japan	Mitsui	15 tpd	Waste		2002	<a href="http://www.mes.co.jp">www.mes.co.jp</a>
300 Toyokawa	Toyokawa City	Toyokawa City, Aichi Prefecture (JP)	Nippon Steel & Sumikin Engineering	2*65 tpd	MSW, Incombustible Residues, Sludge Sludge residues	1.9 MWe	2003	<a href="http://www.eng.rsscnc.com">www.eng.rsscnc.com</a>
301 Trails Road	Plasco	Ottawa (CA)	Plasco	100 tpd	Wastes	CHP		<a href="http://www.plascoenergygroup.com">www.plascoenergygroup.com</a>
302 Tyseley	Birmingham Bio Power Ltd	Birmingham, (UK)	Nuvera	67 000 tpa	Recycle wood RDF	9 MWe	In commissioning	<a href="http://www.cogenuk.com">www.cogenuk.com</a>
303 Tyseley Urban Resource Centre	APP	Birmingham, (UK)	APP (Outtec)	10 000 tpa?	Recyl wood etc.	SNG 1 000 tpa	In construction?	<a href="http://www.advancedplasmagroup.com">www.advancedplasmagroup.com</a>
304 Ube	Ube City	Ube, Yamaguchi (JP)	Ebara	3*66 tpd	MSW	4.1 MWe	2002	<a href="http://www.eep.ebara.com">www.eep.ebara.com</a>
305 Ube	Ube Ammonia	Ube, Yamaguchi (JP)	EUP (Ebara)	30 000 tpa, 2 lines	Plastic waste	Hydrogen for ammonia plant	2000, 2002 operated to 2008	
306 Uim-Wilbingen			Siemens KWU	4 tpd			1988-1996	
307 University Park	BESI	University Park, Ill, USA	BESI	2 tpd pilot	Wastes			<a href="http://besiusa.com">besiusa.com</a>
308 USK	Brooke Energy	USK, Wales (UK)	EQTEC	42 000 tpa	waste wood	6 MWe	In planning	

Project name	Developer	Location	Gasifier	Capacity	Fuels	Applications	Status	Web page
309 Utsahrai		Utsahrai (JP)	Hitchi, AitemNG	5 tpd	Wastes	Power	2002-2013	<a href="http://www.aitemng.com">www.aitemng.com</a>
310 UTE Waste to Energy Facility	U Thong	n.a.	AitemNG	2*300 tpd	RDF	20 MWe	2019	<a href="http://www.aitemng.com">www.aitemng.com</a>
311 Wande	BH EnergyCap	Walsall (UK)	Kobelco	300 000 tpa	Wastes	25 Mwe	In planning, CIP contract	<a href="http://www.bhenrycap.co.uk">www.bhenrycap.co.uk</a>
312 Washwood Heath Energy Recovery Centre	Clean Power Properties Ltd	Birmingham (UK)	Biomass Power Ltd.	> 128 000 tpa		Power	In planning	<a href="http://www.cleanpowerproperties.com">www.cleanpowerproperties.com</a>
313 Wednesbury (SynTech Energy Centre)	SynTech Bioenergy LLC	Wednesbury (UK)	Frontline Bioenergy KEV Technology	40 tpd	RDF	1.3 MWe	In construction	<a href="http://www.kev-tech.com">www.kev-tech.com</a> <a href="http://www.modernpowersystems.com/features/featurehow-waste-gasification-can-clean-up-its-act-6092715/">www.modernpowersystems.com/features/featurehow-waste-gasification-can-clean-up-its-act-6092715/</a> <a href="http://www.coenergy.com">www.coenergy.com</a>
314 Welford	Welford Bio Power CoGen	Welford (UK)	Nektara	67 000 tpa	Recycl wood etc.	10 MWe	2017	<a href="http://www.coenergy.com">www.coenergy.com</a>
315 West Midlands	Innovative Environmental Solutions	Oldbury, West Midlands (UK)	Chinook Sciences	160 000 tpa ASR	ASR	40 MWe	In operation 2016	<a href="http://www.chinooksciences.com">www.chinooksciences.com</a>
316 Westbury	Northacre Renewable Energy Limited. (Hills group)	Westbury (UK)	Chinook Sciences	160 000tpa	RDF	22 MWe gross	In planning, CIP contract 2017	<a href="http://www.chinooksciences.com">www.chinooksciences.com</a> <a href="http://www.hills-group.co.uk/northacre-energy/">www.hills-group.co.uk/northacre-energy/</a>
317 Villanova Mondovi	Energia & Calora	Villanova Mondovi (IT)	Pyrox GmbH	1 MWe	Biomass		In operation	Not available
318 Willesten	Clean Power Properties & Network Rail Infrastructure	Willesten, London (UK)	Not available	8 MWe	Wastes		Planning application submitted 2018	<a href="http://www.cleanpowerproperties.com">www.cleanpowerproperties.com</a>
319 Wirral	Boeseresos Ltd.	Hooton, Liverpool UK	Valmet	260 000 tpa	Waste	50MWe	Planning permission 2014, present status unknown	
320 Wuhan (CH)	Wuhan Kaidi	Wuhan (CH)	AitemNG	4 tpd	Wastes	BTL	Op. 2013	<a href="http://www.aitemng.com">www.aitemng.com</a>
321 Xishui	Schius Xishui Cement	Xishui, Guizhou (CN)	Kawasaki Heavy Industries	300 tpd*1	Wastes	Cement	2016	<a href="http://www.khi.co.jp/english/cplant/index.html">www.khi.co.jp/english/cplant/index.html</a>
322 Yame Sebyr	Yame Sebyr (JP)	Yame Sebyr (JP)	Mitsui	2*5 tpd	Wastes		2000	<a href="http://www.mes.co.jp">www.mes.co.jp</a>
323 Yangdun	Yangdun Conch Cement	Yangdun City, Shangdong (CN)	Kawasaki Heavy Industries	1*200 tpd	Wastes	Cement	2015	<a href="http://www.khi.co.jp/english/cplant/index.html">www.khi.co.jp/english/cplant/index.html</a>
324 Yangju		Yangju, S. Korea	Mitsui	2*100 tpd	Wastes		2009	<a href="http://www.mes.co.jp">www.mes.co.jp</a>
325 Yangsan	Yangsan City	Yangsan, S. Korea	POSCO Ikansee Nippon Steel & Sumikin Engineering	2*100 tpd	MSW, Incombustible Residues	Hot water	2008	<a href="http://www.eng.nssc.com">www.eng.nssc.com</a>
326 Yihin		Yihin (TL)	EER	12-20 tpd			2006	Not available
327 Yokkaichi	Yokkaichi City	Yokkaichi, Mie Prefecture (JP)	Nippon Steel & Sumikin Engineering	3*112 tpd	MSW, Incombustible Residues, Sludge,	9 MWe	2016	<a href="http://www.eng.nssc.com">www.eng.nssc.com</a>
328 Yokohama	Mitsui	Chiba (JP)	Mitsui	1 tpd	waste	demo	1994-200	<a href="http://www.mes.co.jp">www.mes.co.jp</a>
329 Yorii	Yorii ORIX	Yorii (JP)	JFE (Thermoselect)	2*20 tpd	Wastes		2005	<a href="http://www.jfe-eng.co.jp/en/products/environment/">http://www.jfe-eng.co.jp/en/products/environment/</a>
330 Yoroigata Clean Center	Niigata City	Niigata, Niigata Prefecture (JP)	Nippon Steel & Sumikin Engineering	2*60 tpd	MSW, Incombustible Residues, Sludge, Landfill Waste	1.5 MWe	2002	<a href="http://www.eng.nssc.com">www.eng.nssc.com</a>
331 Yoshi		Yoshi (JP)	Hitchi, AitemNG	1 tpd	Wastes	Power	Op. 2000	<a href="http://aitemng.com">aitemng.com</a>
332 Yoshino	Chou Kooki Env. Centre	Yoshino (JP)	JFE (Thermoselect)	1.8 Mwe	Wastes	Power	2005	<a href="http://www.jfe-eng.co.jp/en/products/environment/">http://www.jfe-eng.co.jp/en/products/environment/</a>
333 Yujing	Yujing Ketelin Cement	Yujing, Guizhou (CN)	Kawasaki Heavy Industries	100 tpd*1	Wastes	Cement	2016	<a href="http://www.khi.co.jp/english/cplant/index.html">www.khi.co.jp/english/cplant/index.html</a>
334 Zunyi	Zunyi Conch Panjiang Cement	Zunyi, Guizhou (CN)	Kawasaki Heavy Industries	400 tpd*1 400 tpd*2	Wastes	Cement	2013 & 2015	<a href="http://www.khi.co.jp/english/cplant/index.html">www.khi.co.jp/english/cplant/index.html</a>
335		S.Korea	BEST	100 tpd	Wastes	Power	2015	<a href="http://bestusa.com">bestusa.com</a>



**IEA Bioenergy**



**Further Information**

IEA Bioenergy Website  
[www.ieabioenergy.com](http://www.ieabioenergy.com)

Contact us:  
[www.ieabioenergy.com/contact-us/](http://www.ieabioenergy.com/contact-us/)